

GENESIS II

E-210 GBS • E-310 GBS • E-410 GBS

LPG OWNER'S MANUAL



LET'S GRILL



► **Unlock grilling happiness:** Register your GENESIS II gas grill and receive special content to make you the ultimate backyard hero.

Registration is easy and we only ask a few quick questions. In less than two minutes, activate your unique WEBER-ID, and unlock a lifetime of WEBER knowledge and guidance. Stay inspired along the way.



PHONE



MOBILE



EMAIL



ONLINE



59475

040118

enSA - English (South America)

Keep this Owner's Manual for future reference, thoroughly read through it, and if you have any questions please contact us today—contact information can be found at the back of this manual.

Hello!

We are so glad that you have joined us on the journey to barbecuing happiness. Please take some time to read through this Owner's Manual to ensure that you are up and barbecuing quickly and easily. We want to be with you for the life of your grill, so please take just a couple of minutes to register your grill. We promise that we will never sell your information or spam you with unnecessary emails. What we do promise is to be by your side, every step of the way. When you sign up for a WEBER ID as part of your registration, we will deliver special barbecue-related content just for you to enjoy.

So, come along and join us online, on your smartphone or however else you'd like to stay in touch.

Thank you for choosing WEBER. We are happy you are here.



Important Safety Information

DANGER, WARNING, and CAUTION statements are used throughout this Owner's Manual to emphasise critical and important information. Read and follow these statements to help ensure safety and prevent property damage. The statements are defined below.

⚠ DANGER: Indicates a hazardous situation which, if not avoided, *will result in death or serious injury.*

⚠ WARNING: Indicates a hazardous situation which, if not avoided, *could result in death or serious injury.*

⚠ CAUTION: Indicates a hazardous situation which, if not avoided, *could result in minor or moderate injury.*

⚠ DANGER

If you smell gas:

- Shut off gas to the appliance (barbecue).
- Extinguish any open flame.
- Open lid.
- If odour continues, keep away from the appliance (barbecue) and immediately call your gas supplier or the emergency fire services.

USE OUTDOORS ONLY.

READ THE INSTRUCTIONS BEFORE USING THE APPLIANCE (BARBECUE).

⚠ WARNING

- Do not store or use gasoline or other flammable liquids or vapours in the vicinity of this (barbecue) or any other appliance.
- An LPG cylinder not connected for use shall not be stored in the vicinity of this (barbecue) or any other appliance.

NOTICE TO INSTALLER: These instructions must be left with the consumer.

NOTICE TO CONSUMER: Retain these instructions for future reference.



Installation and Assembly

⚠ **DANGER:** This barbecue is not intended to be installed in or on recreational vehicles or boats.

⚠ **WARNING:** Do not use this barbecue unless all parts are in place and the barbecue was properly assembled according to the assembly instructions.

⚠ **WARNING:** Do not build this model of barbecue in any built-in or slide-in construction.

⚠ **WARNING:** Do not modify the appliance. LP gas is not natural gas. The conversion or attempted use of natural gas in an LP gas unit or LP gas in a natural gas unit is unsafe and will void your warranty.

- Any parts sealed by the manufacturer must not be altered by the user.

Operation

⚠ **DANGER:** Only use the barbecue outdoors in a well-ventilated area. Do not use in a garage, building, breezeway, tent, any other enclosed area, or beneath an overhead combustible structure.

⚠ **DANGER:** Do not use the barbecue in any vehicle or in any storage or cargo area of any vehicle. This includes, but is not limited to, cars, trucks, station wagons, mini-vans, sport utility vehicles, recreational vehicles, and boats.

⚠ **DANGER:** When in use, combustible materials should not be within 61 cm (24 inches) of the back or sides of the barbecue.

⚠ **DANGER:** Keep the cooking area clear of flammable vapours and liquids such as petrol, alcohol, etc., and combustible materials.

⚠ **DANGER:** This appliance must be kept away from flammable materials during use.

⚠ **DANGER:** Do not put a barbecue cover or anything flammable on, or in the storage area under the barbecue while it is in operation or is hot.

⚠ **DANGER:** Should a grease fire occur, turn off all burners and leave lid closed until fire is out.

⚠ **WARNING:** Accessible parts may be very hot. Keep young children away.

⚠ **WARNING:** The use of alcohol, prescription drugs, non-prescription drugs, or illegal drugs may impair the consumer's ability to properly and safely assemble, move, store, or operate the barbecue.

⚠ **WARNING:** Never leave the barbecue unattended during pre-heating or use. Exercise caution when using this barbecue. The entire cookbox gets hot when in use.

⚠ **WARNING:** Use heat-resistant barbecue mitts or gloves when operating barbecue.

⚠ **WARNING:** Do not move the appliance during use.

⚠ **WARNING:** Keep any electrical supply cord and the fuel supply hose away from any heated surfaces.

⚠ **CAUTION:** This product has been safety-tested and is only certified for use in a specific country. Refer to country designation located on outside of box.

- Do not use charcoal, briquettes or lava rock in the barbecue.

Storage and/or Nonuse

⚠ **WARNING:** Turn off the gas supply at the gas cylinder after use.

⚠ **WARNING:** LPG cylinders must be stored outdoors out of the reach of children and must not be stored in a building, garage or any other enclosed space.

⚠ **WARNING:** After a period of storage and/or nonuse, the barbecue should be checked for gas leaks and burner obstructions before use.

- Storage of the barbecue indoors is permissible only if the LPG cylinder is disconnected and removed from the barbecue.

The grills illustrated in this Owner's Manual may vary slightly from the model purchased.

TABLE OF CONTENTS

2	Welcome to WEBER Important Safety Information
4	Product Features The GS4 Grilling System Genesis® II Features
6	Tips and Hints The Flame - Direct or Indirect Grilling Do's and Don'ts
8	The WEBER Promise Warranty
9	Getting Started Important Information about LP Gas & Gas Connections Specific Requirements for Customers in Latin America LPG Cylinder Installation & Leak Checking
12	Operation The Very First Time You Grill Every Time You Grill Igniting the Grill
14	Product Care Cleaning and Maintenance
16	Troubleshooting
18	Grilling Guide
19	Replacement Parts

**ALWAYS
HAVE THE
LATEST AND
GREATEST**

The most recent version of this
Owner's Manual can be
found online.

THE GS4 GRILLING SYSTEM

The GS4 High Performance Grilling System sets a new standard in the world of backyard cuisine, and lands the GENESIS II and GENESIS II LX series of gas grills in a class of their own. This innovative grilling system is based on over 30 years of grilling experience, culinary expertise, and most importantly, avidly considering the wants and needs of the people who matter most – the grilling community.

Each component of GS4 was uniquely designed for ease-of-use and to provide an unequalled satisfaction to your backyard grilling experience. Promising burners that are ensured to ignite every time, smoke infused food that grills evenly and consistently regardless of where it's placed on the cooking grate, and hassle free cleanup; you are able to focus on what it's all about – bringing people together around the grill.

The GS4 grilling system is composed of four key components: The INFINITY Ignition, High Performance Burners, FLAVORIZER BARS, and Grease Management System. These components ensure that every aspect of your grilling experience is easy and reliable; from the moment the burners are lit to the general maintenance of your grill. And together, create the strongest grilling engine within every GENESIS II and GENESIS II LX grill.



1 INFINITY Ignition

The INFINITY Ignition is ensured to ignite every time. Backed by a generous warranty, rest assured that you'll be up-and-grilling the first time, every time.

2 High Performance Burners

The unique, tapered shape delivers a consistent gas flow from front to back. This provides ultimate heat distribution, ensuring that food grills evenly and consistently anywhere on the cooking grate.

3 FLAVORIZER BARS

The classic WEBER FLAVORIZER BARS are angled just right to catch drippings that smoke and sizzle, adding that irresistible smoky flavor that we all know and love to your food. Any drippings not vaporised follow the slope and are funneled away from the burners, down into the grease management system.

4 Grease Management System

The grease management system helps with the removal of grease while reducing the risk of flare-ups. Drippings that are not vaporised by the FLAVORIZER BARS are funneled away from the burners into the disposable drip tray, located within the catch pan under the cookbox. Simply remove the catch pan and replace the drip tray as needed.



GENESIS II FEATURES



A Side Tables with Integrated Tool Hooks

Use the side table to keep platters, seasonings, and tools within arm's reach. Hang your essential grilling tools on the hooks for easy access and organisation of your backyard workspace. The left side table folds down in models equipped with two and three burners.

B Built-In Thermometer

Being aware of the temperature inside of your grill allows you to adjust the heat when needed.

C GOURMET BBQ SYSTEM Cooking Grate

Remove the circular grate insert and transform your grill into a griddle, poultry roaster, pizza stone or any other of the many GOURMET BBQ SYSTEM options to choose from.

D TUCK-AWAY Warming Rack

The TUCK-AWAY warming rack keeps food warm or toasts burger buns, as the main meal cooks below. The unique TUCK-AWAY feature allows you to fold it down when not in use, providing optimal grilling space and convenient in-the-grill storage.

E iGRILL 3 Ready

The newest grilling essential- the iGRILL 3 digital Bluetooth thermometer monitors your food from beginning to end, displaying the real-time temperature on your mobile device. Once you've downloaded the WEBER iGRILL app, connect the iGRILL to Bluetooth, and run up to four thermometer probes from your grill to the food. (Sold separately.)

F Easy Access Gas Cylinder Storage

Mounting the gas cylinder to the outside of the grill makes the cylinder easy to access and remove; while also increasing storage space in the cart.

G Open Cart Design

The sleek open-cart design provides additional room and accessibility of your grilling tools.

The Flame- Direct or Indirect

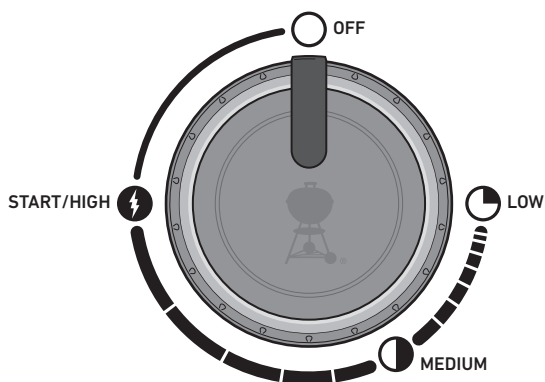

DIRECT HEAT SETUP

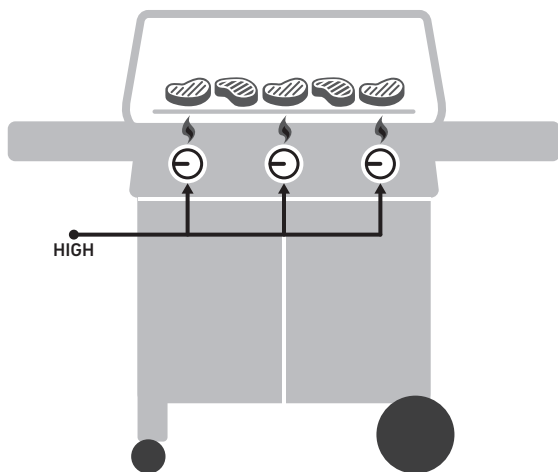

DIRECT HEAT SETUP

Use the direct method for small, tender pieces of food that take less than 20 minutes to cook, such as: hamburgers, steaks, chops, kebab sticks, boneless chicken pieces, fish fillets, shellfish, and sliced vegetables.

With direct heat, the fire is right below the food. It sears the surfaces of the food, developing flavours, texture, and delicious caramelisation while cooking the food all the way to the centre.

INDIRECT HEAT SETUP

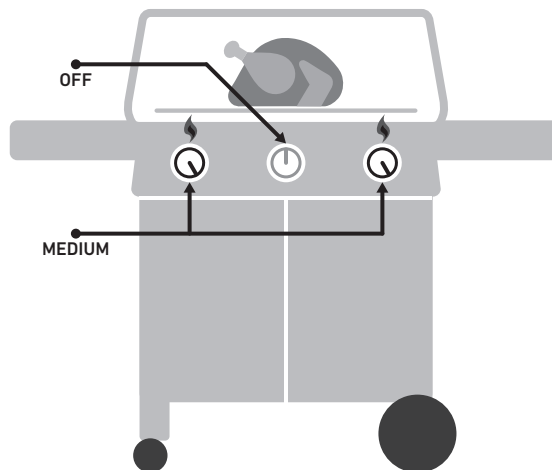

INDIRECT HEAT SETUP

Use the indirect method for larger cuts of meat that require 20 minutes or more of barbecuing time, or for foods so delicate that direct exposure to the heat would dry them out or scorch them, such as: roasts, bone-in poultry pieces, whole fish, delicate fish fillets, whole chickens, turkeys, and ribs. Indirect heat can also be used for finishing thicker foods or bone-in cuts that have been seared or browned first over direct heat.

With indirect heat, the heat is on both sides of the barbecue, or off to one side of the barbecue. The food sits over the unlit part on the cooking grate.

Barbecuing Do's and Don'ts

Preheat each and every time.

If the cooking grates aren't hot enough, food will stick, and you will likely never have a chance of searing properly or developing those handsome barbecue marks. Even if a recipe calls for medium or low heat, always preheat the barbecue on the highest setting first. Open the lid, turn up the heat, close the lid, and then let the cooking grate heat up for about ten minutes or until the lid thermometer reads 260°C (500°F).

Don't barbecue on dirty grates.

Tossing food onto the cooking grates before they have been cleaned is never a good idea. Leftover "stuff" on the grates acts like glue, binding it to the grates and your new food. To avoid tasting last night's dinner on today's lunch, make sure that you are barbecuing on a clean cooking grate. Once the grates are preheated, use a stainless steel bristle barbecue brush to make a clean, smooth surface.

Be present in the process.

Before firing up your barbecue, make sure that everything you need is within arm's reach. Don't forget your essential barbecuing tools, already oiled and seasoned food, glazes or sauces, and clean cooking platters for cooked food. Having to run back to your kitchen not only means missing out on the fun, but could also result in burning your food. French chefs call this "mise en place" (meaning, "put in place"). We call it "being present".

Create a little elbow room.

Packing too much food onto the cooking grates restricts your flexibility. Leave at least one-quarter of the cooking grates clear, with plenty of space between each food item, in order to get your tongs in there and easily move the food around. Sometimes barbecuing involves split-second decisions and the ability to jockey food from one area to another. So give yourself enough room to operate.

Try not to peek.

The lid on your barbecue is for more than just keeping the rain out. Most importantly, it's for preventing too much air from getting in, and too much heat and smoke from getting out. When the lid is closed, the cooking grates are hotter, the barbecuing times are faster, the smoky tastes are stronger, and the flare-ups are fewer. So put a lid on it!

Only flip once.

What's better than a juicy steak with a deep sear and plenty of beautifully caramelised bits? The key to accomplishing these results is to keep your food in place. Sometimes we have the tendency to flip our food before it reaches the desirable level of colour and flavour. In nearly all cases, you should turn food just once. If fiddling with it more than that, you are probably also opening the lid too much, which causes its own set of problems. So step back and trust the barbecue.

Know when to tame the flame.

When barbecuing, sometimes the most important thing to know is when to stop. The most reliable way to test doneness of your food is to invest in an instant-read thermometer. This slim little gem will help you pinpoint that critical moment when your food is at its best.

Don't be afraid to experiment.

Back in the 1950s, barbecuing meant one thing: meat (and only meat) charred over open flames. The modern day backyard chef doesn't need a kitchen in order to prepare a full course meal. Use your barbecue to make char-barbecued appetisers, sides, and even desserts. Register your barbecue to receive special content that will inspire you along the way. We'd love to join you on your barbecuing adventures.



TONGS

Consider these to be an extension of your hand. The best tongs should have an effortless tension mechanism, comfortable hand grips, and a lock to keep them compact.



SPATULA

Look for a long-handled spatula designed with a bent (offset) neck so that the blade is set lower than the handle. This makes it easier to lift food off the cooking grates.



TIMER

Avoid the disappointment of torching your dinner by simply setting a timer. Nothing fancy needed—just one that is reliable and easy to use.

The WEBER Promise (10 year EMEA voluntary warranty)

At WEBER, we pride ourselves on two things: making barbecues that last and providing a lifetime of excellent customer service.

Thank you for purchasing a WEBER product. Weber-Stephen Products LLC, 1415 S. Roselle Road, Palatine, Illinois 60067 and its International Business Units (listed at the end of this manual) ("WEBER") pride ourselves on delivering a safe, durable, and reliable product.

This is WEBER's Voluntary Warranty provided to you at no extra charge. It contains the information you will need to have your WEBER product repaired or replaced in the unlikely event of a failure or defect.

Pursuant to applicable laws, the Owner has several rights in case the product is defective. Those rights may include supplementary performance or replacement, abatement of the purchasing price, and compensation. In some countries in the European Union, for example, this would be a two-year statutory right starting on the date of the handover of the product. These and other statutory rights remain unaffected by this Voluntary Warranty provision. In fact, this Voluntary Warranty grants additional rights to the Owner that are independent from statutory provisions.

WEBER's Voluntary Warranty

WEBER warrants, to the Purchaser of the WEBER product (or in case of a gift or promotional situation, the person for whom it was purchased as a gift or promotional item) ("Owner") that the WEBER product is free from defects in material and workmanship for ten (10) years from the date of purchase when assembled and operated in accordance with the accompanying Owner's Manual. (Note: If you lose or misplace your WEBER Owner's Manual, a replacement is available online at www.weber.com) The Warranty is applicable in Europe, the Middle East and Africa (EMEA). WEBER agrees to repair or replace the part that is defective in material or workmanship subject to the limitations, disclaimers, and exclusions listed below. TO THE EXTENT ALLOWABLE BY APPLICABLE LAW, THIS WARRANTY IS EXTENDED ONLY TO THE ORIGINAL PURCHASER AND IS NOT TRANSFERABLE TO SUBSEQUENT OWNERS, EXCEPT IN THE CASE OF GIFTS AND PROMOTIONAL ITEMS AS NOTED ABOVE.

WEBER stands by its products and is happy to provide you with this Voluntary Warranty described for material defects in the barbecue or its relevant components, normal wear and tear excepted.

- 'Normal wear and tear' includes cosmetic and other immaterial deterioration that may come with ownership of your barbecue over time, such as surface rust, dents / scratches, etc.

However, WEBER will honour this Voluntary Warranty for the barbecue or its relevant components where damage or dysfunction results from a material defect.

- 'Material defect' includes rust through or burn through of certain parts, or other damage or failure inhibiting your ability to safely / properly use your barbecue.

Owner's Responsibilities Under this Voluntary Warranty / Exclusion of Warranty

To ensure trouble-free Warranty coverage, it is important (but not required) that you register your WEBER product online at www.weber.com. Please also retain your original sales receipt and/or invoice as Proof of Purchase is required for Warranty coverage. WEBER will also require photographs of any alleged defect, and the serial number of your barbecue, prior to processing a Warranty claim. Registering your WEBER product confirms your Warranty coverage and provides a direct link between you and WEBER in case we need to contact you.

The above Voluntary Warranty only applies if the Owner takes reasonable care of the WEBER product by following all assembly instructions, usage instructions, and preventative maintenance as outlined in the accompanying Owner's Manual, unless the Owner can prove that the material defect or failure is independent of non-compliance with the above mentioned obligations. If you live in a coastal area, or have your product located near a pool, maintenance includes regular washing and rinsing of the exterior surfaces as outlined in the accompanying Owner's Manual.

This Voluntary Warranty lapses if there are damages, deteriorations, discolourations, and/or rust for which WEBER is not responsible caused by:

- Abuse, misuse, alteration, modification, misapplication, vandalism, neglect, improper assembly or installation, and failure to properly perform normal and routine maintenance;
- Insects (such as spiders) and rodents (such as squirrels), including but not limited to damage to gas hoses;
- Exposure to salt air and/or chlorine sources such as swimming pools and hot tubs/spas;
- Severe weather conditions such as hail, hurricanes, earthquakes, tsunamis or surges, tornadoes or severe storms.
- Acid rain and other environmental factors.

The use and/or installation of parts on your WEBER product that are not genuine WEBER parts will void this Voluntary Warranty, and any damages that result hereby are not covered by this Voluntary Warranty. Any conversion of a gas barbecue not authorised by WEBER and performed by a WEBER authorized service technician will void this Voluntary Warranty.

Warranty Processing

If you believe that you have a part which is covered by this Voluntary Warranty, please contact your purchase dealer. If needed, you may also contact WEBER Customer Service using the contact information on our website (www.weber.com). WEBER will, upon investigation, repair or replace (at its option) a defective part that is covered by this Voluntary Warranty. In the event that repair or replacement are not possible, WEBER may choose (at its option) to replace the barbecue in question with a new barbecue of equal or greater value. WEBER may ask you to return parts for inspection, shipping charges to be pre-paid by the Owner. The shipping charges will be reimbursed to the Owner if the defect is covered by the Warranty.

When you contact your purchase dealer, please have the following information available:

- Proof of Purchase
- Photographs of the alleged defect
- Product serial number

Disclaimers

APART FROM THE WARRANTY AND DISCLAIMERS AS DESCRIBED IN THIS VOLUNTARY WARRANTY STATEMENT, THERE ARE EXPLICITLY NO FURTHER WARRANTY OR VOLUNTARY DECLARATIONS OF LIABILITY GIVEN HERE WHICH GO BEYOND THE STATUTORY LIABILITY APPLYING TO WEBER. THE PRESENT VOLUNTARY WARRANTY STATEMENT ALSO DOES NOT LIMIT OR EXCLUDE SITUATIONS OR CLAIMS WHERE WEBER HAS MANDATORY LIABILITY AS PRESCRIBED BY STATUTE.

NO WARRANTIES SHALL APPLY AFTER THE TEN (10) YEAR PERIOD OF THIS VOLUNTARY WARRANTY. NO OTHER WARRANTIES GIVEN BY ANY PERSON, INCLUDING A DEALER OR RETAILER, WITH RESPECT TO ANY PRODUCT (SUCH AS ANY "EXTENDED WARRANTIES"), SHALL BIND WEBER. THE EXCLUSIVE REMEDY OF THIS VOLUNTARY WARRANTY IS REPAIR OR REPLACEMENT OF THE PART OR PRODUCT.

IN NO EVENT UNDER THIS VOLUNTARY WARRANTY SHALL RECOVERY OF ANY KIND BE GREATER THAN THE AMOUNT OF THE PURCHASE PRICE OF THE WEBER PRODUCT SOLD.

PARTS AND ACCESSORIES REPLACED UNDER THIS VOLUNTARY WARRANTY ARE WARRANTED ONLY FOR THE REMAINING PERIOD OF THE ABOVE MENTIONED ORIGINAL TEN (10) YEAR VOLUNTARY WARRANTY PERIOD.

THIS LIMITATION DOES NOT APPLY IN CASES OF INTENT AND GROSS NEGLIGENCE AND CASES OF INJURY TO HUMAN LIFE OR HEALTH OR PERSONAL INJURY WHETHER THE INJURY WAS THE FAULT OF WEBER OR ITS LEGAL REPRESENTATIVES OR AGENTS.

THIS VOLUNTARY WARRANTY APPLIES TO PRIVATE USE ONLY AND DOES NOT APPLY TO WEBER BARBECUES USED IN COMMERCIAL, COMMUNAL OR MULTI-UNIT SETTINGS SUCH AS RESTAURANTS, HOTELS, RESORTS, OR RENTAL PROPERTIES.

WEBER MAY FROM TIME TO TIME CHANGE THE DESIGN OF ITS PRODUCTS. NOTHING CONTAINED IN THIS VOLUNTARY WARRANTY SHALL BE CONSTRUED AS OBLIGATING WEBER TO INCORPORATE SUCH DESIGN CHANGES INTO PREVIOUSLY MANUFACTURED PRODUCTS, NOR SHALL SUCH CHANGES BE CONSTRUED AS AN ADMISSION THAT PREVIOUS DESIGNS WERE DEFECTIVE.



**PROTECT
YOUR
INVESTMENT**

Shield your grill from the elements with a heavy-duty premium grill cover.

GENESIS II Burner Consumption Data

CONSUMPTION DATA			
2 Burner Models	3 Burner Models	4 Burner Models	6 Burner Models
7,6 kW Propane	11,0 kW Propane	14,1 kW Propane	17,6 kW Propane
8,7 kW Butane	12,6 kW Butane	16,2 kW Butane	20,2 kW Butane
7,6 kW GLP	11,0 kW GLP	14,1 kW GLP	17,6 kW GLP
543 g/h Propane	786 g/h Propane	1008 g/h Propane	1258 g/h Propane
633 g/h Butane	917 g/h Butane	1179 g/h Butane	1470 g/h Butane
543 g/h GLP	786 g/h GLP	1008 g/h GLP	1258 g/h GLP

Important Information about LP Gas & Gas Connections

What is LPG?

Liquefied petroleum gas, also called LPG or LP gas, is the flammable, petroleum-based product used to fuel your barbecue. It is a gas at moderate temperatures and pressure when it is not contained. But at moderate pressure inside a container, such as a cylinder, LPG is a liquid. As pressure is released from the cylinder, the liquid readily vaporises and becomes gas.

Safe Handling Tips for LPG Cylinders

- A dented or rusty LPG cylinder may be hazardous and should be checked by your LP gas supplier. Do not use a cylinder with a damaged valve.
- Although your LPG cylinder may appear to be empty, gas may still be present, and the cylinder should be transported and stored accordingly.
- The LPG cylinder must be installed, transported, and stored in an upright, secure position. Cylinders should not be dropped or handled roughly.
- Never store or transport the LPG cylinder where temperatures can reach 50°C (125°F) (the cylinder will become too hot to hold by hand).

LPG Cylinder Requirements

- Use cylinders with a minimum capacity of 3 kg and a maximum capacity of 13 kg.

What is a Regulator?

Your gas barbecue is equipped with a pressure regulator, which is a device to control and maintain uniform gas pressure as gas is released from the LPG cylinder.

Regulator and Hose Requirements

- In the United Kingdom, this barbecue must be fitted with a regulator complying with BS 3016, having a nominal output of 37 millibars.
- The length of the hose must not exceed 1.5 metres.
- Avoid kinking the hose.
- Replacement regulator and hose assemblies must be as specified by Weber-Stephen Products LLC.

Specific Requirements for Customers in Latin America

LPG Cylinder Requirements

- For customers in Chile, use cylinders with a minimum capacity of 11 kg and a maximum capacity of 15 kg.

△ IMPORTANT: We recommend that you replace the gas hose assembly on your gas barbecue every five years. Some countries may have requirements that the gas hose be replaced within less than five years, in which case that country's requirement would take precedence.

For replacement hose, regulator, and valve assemblies, contact the Customer Service Representative in your area using the contact information on our web site. Log on to weber.com.



BRUSH AND MOP

Look for a basting brush with heat-resistant silicone bristles and a long handle. A mop with long, cotton threads that sop up the thinner, vinegar-based sauces.



TONGS

Consider these to be an extension of your hand. The best tongs should have an effortless tension mechanism, comfortable hand grips, and a lock to keep them compact.

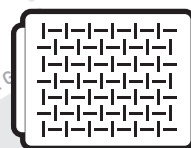

GRILLING PAN

Designed for food that is either too small or too delicate for the cooking grates, a perforated grilling pan keeps food right where it ought to be—on the grill, not in it.

LPG Cylinder Installation & Leak Checking

Connect the Regulator to the Cylinder

- 1) Check that all burner control knobs are in the off \bigcirc position. Check by pushing in and turning knobs clockwise.

- 2) Identify your regulator type and connect the regulator to the LPG cylinder by following the appropriate connection instructions.

Note: Confirm that the LPG cylinder valve or regulator lever are closed before connecting.

Connect by Turning Clockwise (A)

Screw regulator onto cylinder by turning fitting clockwise (a). Position the regulator so that the vent hole (b) faces down.

Connect by Turning Anti-Clockwise (B)

Screw regulator onto cylinder by turning fitting anti-clockwise.

Connect by Turning Lever and Snapping into Position (C)

Turn regulator lever (a) clockwise to the off position. Push regulator down on cylinder valve until regulator snaps into position (b).

Connect by Sliding Collar (D)

Make sure regulator lever is in the off position (a). Slide the collar of the regulator up (b). Push the regulator down onto the cylinder valve and maintain pressure. Slide collar down to close (c). If regulator does not lock, repeat procedure.

Note: The regulator illustrations shown in this manual may not be similar to the regulator you are using for your grill, due to different country or regional regulations. In the case of regulations in Chile, consider the hose and regulator in image D.

Placement of the LPG Cylinder

- 1) Place the cylinder on the ground outside the base cabinet on the right side of the grill. Turn the cylinder so the valve opening faces the front of the grill (E).

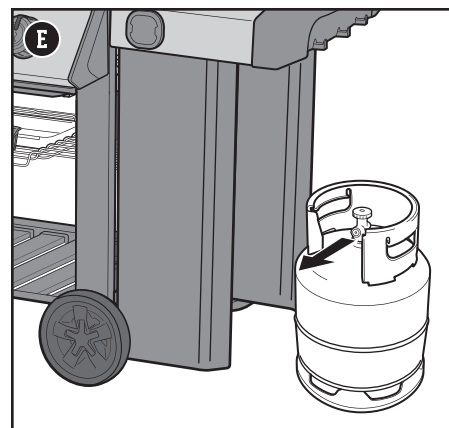
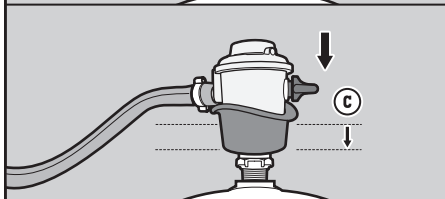
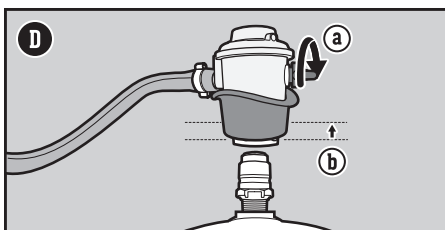
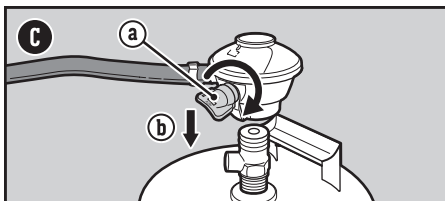
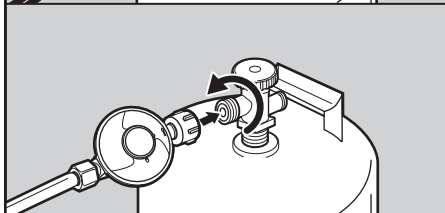
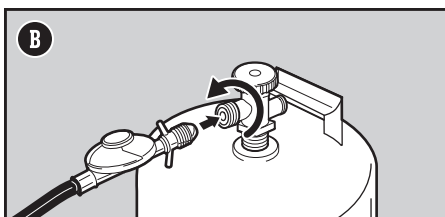
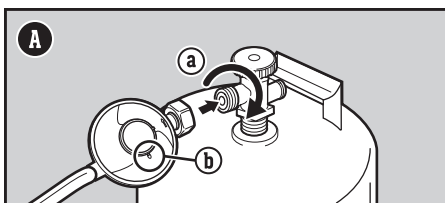

What is a Leak Check?

Once the LPG cylinder is properly installed, it is necessary to perform a leak check. A leak check is a reliable way to verify that gas is not escaping after you connect the cylinder. The fitting where the regulator connects to the cylinder should be tested each time a cylinder is refilled and reinstalled.

Checking for Gas Leaks

- 1) Wet fittings at cylinder and regulator with a soap and water solution, using a spray bottle, brush or rag. You can make your own soap and water solution by mixing 20% liquid soap with 80% water; or, you can purchase leak check solution in the plumbing section of any hardware store.
- 2) Identify your regulator type. Turn gas supply on by turning cylinder valve anti-clockwise (**G**) or by moving regulator lever to the on position (**H**).
- 3) If bubbles appear (**I**) at the regulator-to-cylinder connection or the regulator hose-to-regulator connection, there is a leak:
 - a) Turn gas supply off. **DO NOT OPERATE THE GRILL.** Contact the Customer Service Representative in your area using the contact information on our website.
- 4) If bubbles do not appear, leak checking is complete:
 - a) Turn gas supply off and rinse connections with water.

NOTE: Since some leak test solutions, including soap and water, may be slightly corrosive, all connections should be rinsed with water after checking for leaks.

Additional Leak Check Precautions

The fuel system in your grill features other connections and fittings. These factory-made connections have been thoroughly checked for gas leaks and the burners have been flame-tested. WEBER recommends performing an additional thorough leak check after assembly, as well as annually. Instructions for this can be found online at weber.com.

Disconnect the Regulator from the Cylinder

- 1) Confirm that the LPG cylinder valve or regulator lever are fully closed.
- 2) Disconnect the regulator.

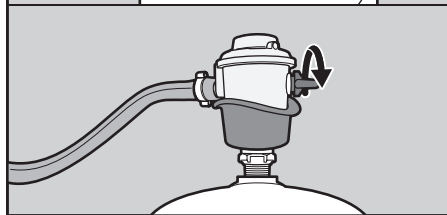
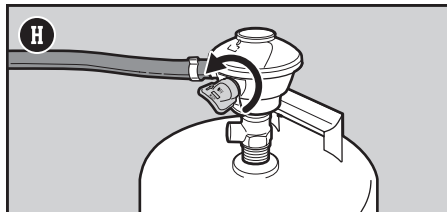
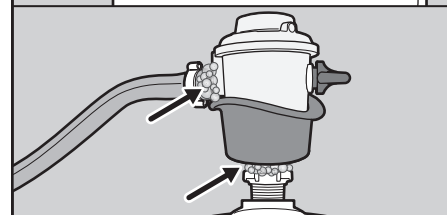
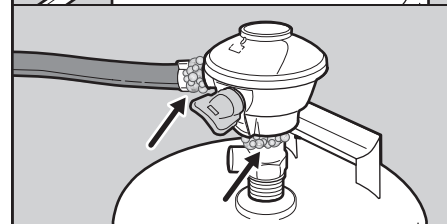
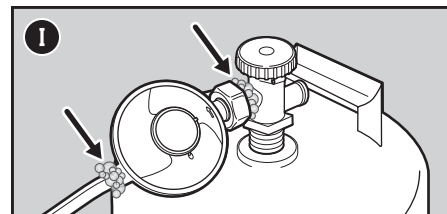
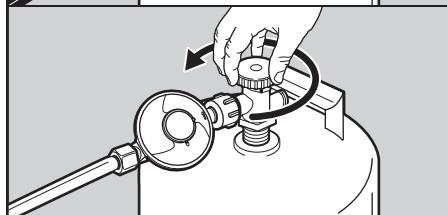
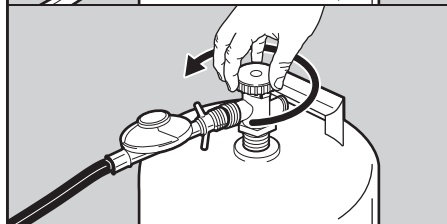
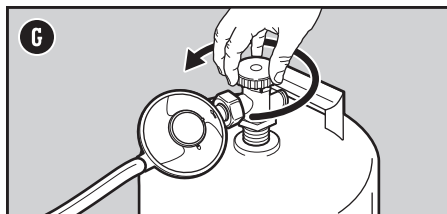

⚠ **DANGER:** Do not use a flame to check for gas leaks. Be sure there are no sparks or open flames in the area while you check for leaks.

⚠ **DANGER:** Leaking gas may cause a fire or explosion.

⚠ **DANGER:** Do not operate the barbecue if there is a gas leak present.

⚠ **DANGER:** If you see, smell, or hear the hiss of gas escaping from the LPG cylinder:

1. Move away from LPG cylinder.
2. Do not attempt to correct the problem yourself.
3. Call the emergency fire services.

⚠ **DANGER:** Always close the cylinder valve before disconnecting the regulator. Do not attempt to disconnect the gas regulator and hose assembly or any gas fitting while this barbecue is in operation.

⚠ **DANGER:** Do not store a spare LPG cylinder under or near this barbecue. Never fill the cylinder beyond 80% full. Failure to follow these statements exactly may result in a fire causing death or serious injury.



FOIL PANS

Perfect for lining the catch pan to make cleanup convenient and easy.

The Very First Time You Grill

Perform an Initial Burn-Off

Heat the grill on the highest setting, with the lid closed, for at least 20 minutes prior to grilling for the first time.

Every Time You Grill

Meal-to-Meal Maintenance

The Meal-To-Meal Maintenance plan includes the following simple, yet important, steps that should always be performed prior to grilling.

Check for Grease

Your grill was built with a grease management system that funnels grease away from food and into a disposable container. As you cook, grease is channeled down the slide-out grease tray and into a disposable drip tray that lines the catch pan. This system should be cleaned each and every time you grill to prevent fires.

- 1) Confirm that the grill is off and cool.
- 2) Remove the slide-out grease tray by pulling the tray out of the cabinet (A). Remove excess grease with a plastic scraper.
- 3) Remove the catch pan by pressing down on the catch pan latch (B). Check for excessive amounts of grease in the disposable drip tray that lines the catch pan. Discard disposable drip pan when necessary and replace with a new one.
- 4) Reinstall all components.

Inspect the Hose

Routine inspection of the hose is necessary.

- 1) Confirm that the grill is off and cool.
- 2) Check hose for any signs of cracking, abrasions, or cuts (C). If the hose is found to be damaged in any way, do not use the grill.

Preheat the Grill

Preheating the grill is critical to successful grilling. Preheating helps to prevent food from sticking to the grate and gets the grate hot enough to sear properly. It also burns off residue of a previously cooked meal.

- 1) Open the grill lid.
- 2) Ignite your grill according to the ignition instructions in this Owner's Manual.
- 3) Close lid.
- 4) Preheat the grill with all burners on the start/high  position for 10 to 15 minutes or until thermometer registers 260°C (500°F) (D).

Clean the Cooking Grate

After preheating, any bits of food or debris left over from previous use will be easier to remove. Cleaned grates will also prevent your next meal from sticking.

- 1) Brush the grates with a stainless steel bristle grill brush immediately after preheating (E).

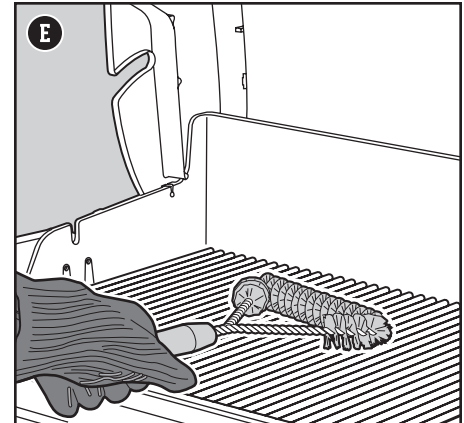
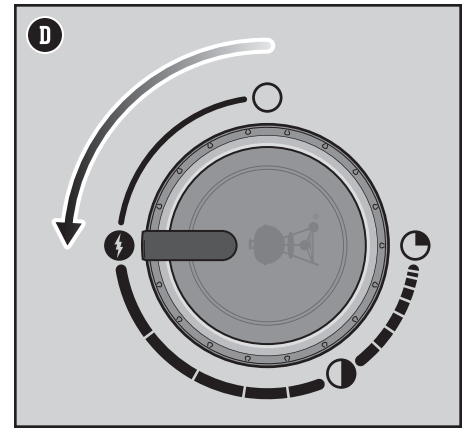
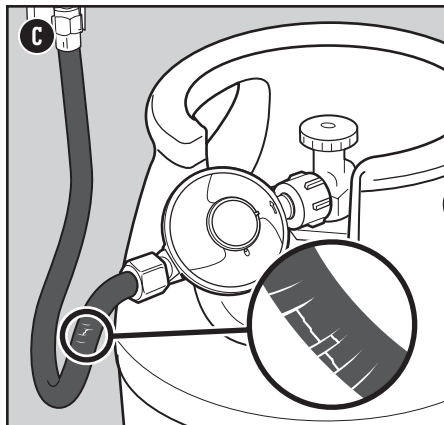
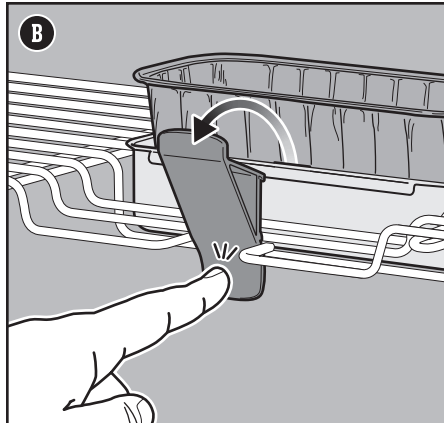
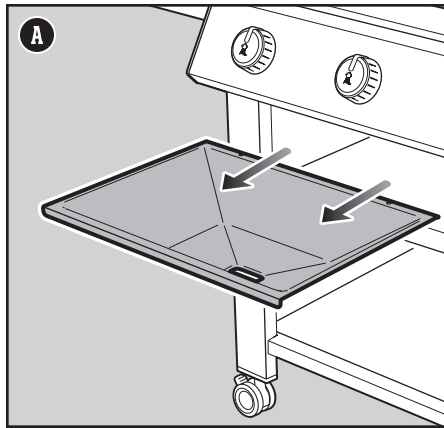

⚠ DANGER: Do not line the slide-out grease tray or cookbox with aluminum foil.

⚠ DANGER: Check the slide-out grease tray and catch pan for grease build-up before each use. Remove excess grease to avoid a grease fire.

⚠ WARNING: Use heat-resistant barbecue mitts or gloves when operating barbecue.

⚠ WARNING: Grill brushes should be checked for loose bristles and excessive wear on a regular basis. Replace brush if any loose bristles are found on cooking grates or brush. WEBER recommends purchasing a new stainless steel bristle grill brush at the beginning of every spring.

⚠ WARNING: If the hose is found to be damaged in any way, do not use the grill. Replace using only WEBER authorised replacement hose.

⚠ WARNING: Keep ventilation openings around tank clear and free of debris.

Igniting the Grill

Using the Electronic Ignition System to Ignite the Grill

Each control knob operates an individual burner, and each burner ignites independently. Ignite the burners starting from left to right. All burners should be lit for preheating, however, all burners do not have to be lit while grilling.

- 1) Open the grill lid (A).
- 2) Check that all burner control knobs are in the off \circ position. Check by pushing in and turning knobs clockwise (B).
Note: It is important that all burner control knobs are in the off \circ position before turning on the LPG cylinder.
- 3) Turn gas supply on by turning cylinder valve anti-clockwise or by moving regulator lever to the on position depending on your regulator/cylinder connection.
- 4) Begin with the burner furthest to the left. Push the burner control knob in and turn it anti-clockwise to the start/high ⚡ position (C).
- 5) Push and hold the electronic ignition button (D). You will hear it ticking.
- 6) Check that the burner is lit by looking through the cooking grates and through the half-circle cutout in the FLAVORIZER BARS.
- 7) If the burner does not ignite, turn burner control knob to the off \circ position and wait five minutes to allow the gas to clear before attempting to light the burner again.
- 8) If the burner ignites, repeat steps 4 through 6 to light the remaining burners.

Should the burners fail to ignite using the electronic ignition, refer to the TROUBLESHOOTING section. There you will find instructions on igniting the grill with a match to help determine the exact problem.

To Extinguish Burners

- 1) Push each burner control knob in and then turn clockwise all the way to the off \circ position.
- 2) Turn gas supply off at the LPG cylinder.

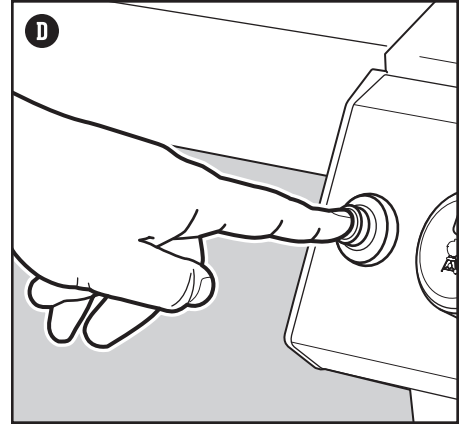
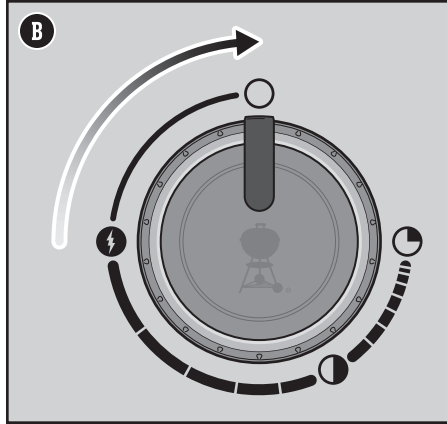
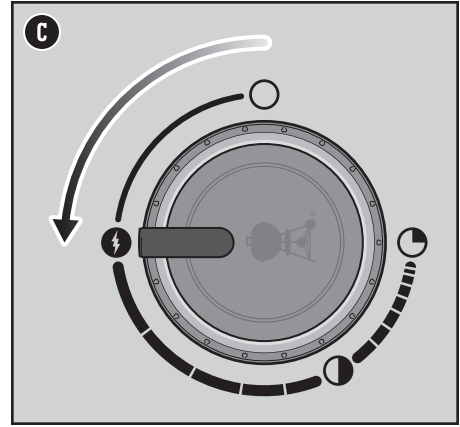
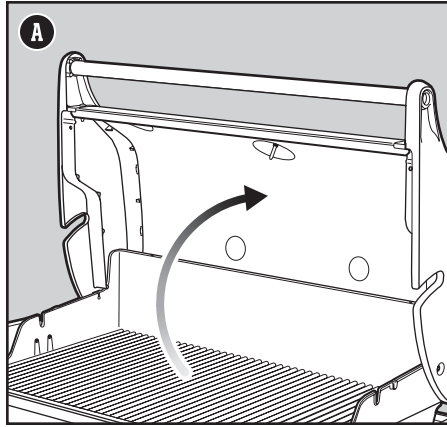

- ⚠ **WARNING:** Open lid during ignition.
- ⚠ **WARNING:** Do not lean over open grill while igniting or cooking.
- ⚠ **WARNING:** Each burner must be ignited individually by pushing the electronic ignition button.
- ⚠ **WARNING:** If ignition does not occur within four seconds of attempting to light the first burner, turn the burner control knob to the off position. Wait five minutes to allow accumulated gas to dissipate, and then repeat the lighting procedure.



BARBECUE MITTS
 When it doubt, wear them. The good ones are insulated and protect both hand and forearm.

MUST-HAVE GRILLING TOOLS • MUST-HAVE GRILLING TOOLS • MUST-HAVE GRILLING TOOLS • MUST-HAVE GRILLING TOOLS • MUST-HAVE GRILLING TOOLS

Optimize Grill Space

Using the TUCK-AWAY Warming Rack

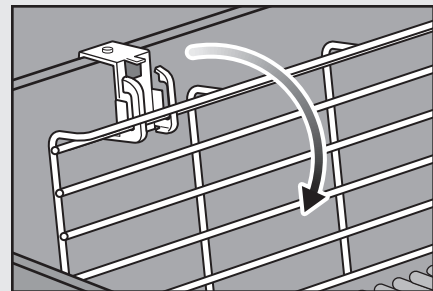
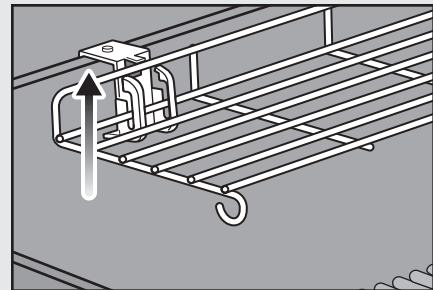
Use the warming rack up to keep food warm or fold it down when not in use. To fold the warming rack down, lift rack slightly and rotate downward. Use heat-resistant mitts or gloves when adjusting rack.



Cleaning and Maintenance

Cleaning the Inside of the Grill

Over time, the performance of your grill can diminish if it has not been maintained properly. Low temperatures, uneven heat, and food sticking to cooking grates are all signs that cleaning and maintenance are overdue. When your grill is off and cool, start by cleaning the inside, from the top down. A thorough cleaning is recommended at least twice a year. Consistent use may require quarterly cleanings.

Cleaning the Lid

From time to time you may notice "paint-like" flakes on the inside of the lid. During use, grease and smoke vapours slowly change into carbon and deposit on the inside of your lid. These deposits will eventually peel, and look very similar to paint. These deposits are non-toxic, but the flakes could fall onto your food if you do not clean the lid regularly.

- 1) Brush the carbonised grease from the inside of the lid with a stainless steel bristle grill brush (A). To minimise further build-up, the inside of the lid can be wiped with a paper towel after grilling while the grill is still warm (not hot).

Cleaning the Cooking Grates

If you have been cleaning your cooking grates as recommended, the debris on your grates should be minimal.

- 1) With grates installed, brush the debris off your cooking grate with a stainless steel bristle grill brush (B).
- 2) Take the grates out and set aside.

Cleaning the FLAVORIZER BARS

FLAVORIZER BARS catch drippings that smoke and sizzle, adding flavour to your food. Any drippings that are not vaporised by the FLAVORIZER BARS are funneled away from the burners. This helps prevent flare-ups inside of your grill, and protects the burners from getting clogged.

- 1) Scrape the FLAVORIZER BARS with a plastic scraper (C).
- 2) If necessary, brush the FLAVORIZER BARS with a stainless steel bristle grill brush.
- 3) Remove FLAVORIZER BARS and set aside.

Cleaning the Burners

Two areas on the burners that are key to optimum performance are the ports (small raised openings running along the length of the burners) and the spider/insect screens on the ends of the burner. Keeping these areas clean is essential for safe operation.

Cleaning the Burner Ports

- 1) Use a clean stainless steel bristle grill brush to clean the outside of the burners by brushing across the top of the burner ports (D).
- 2) When cleaning the burners, avoid damaging the ignition electrode by carefully brushing around it (E).

Cleaning the Spider Screens

- 1) Locate the ends of the burners on the underside of the control panel where they meet the valves.
- 2) Clean the spider/insect screens on each of the burners using a soft bristle brush (F).

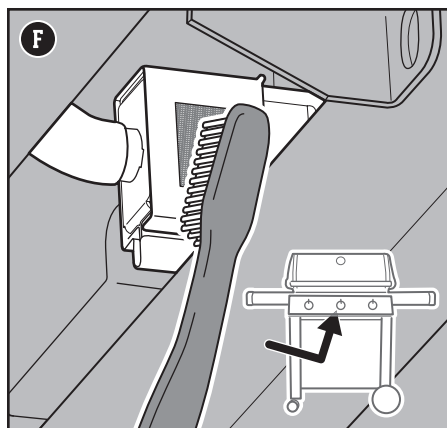
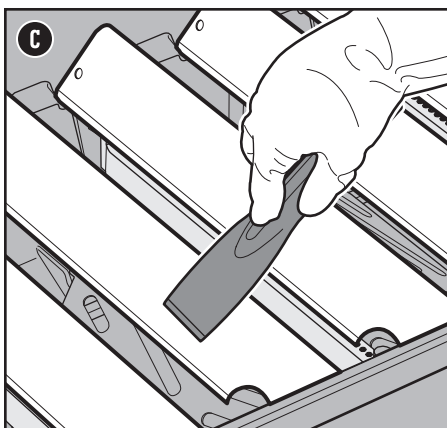
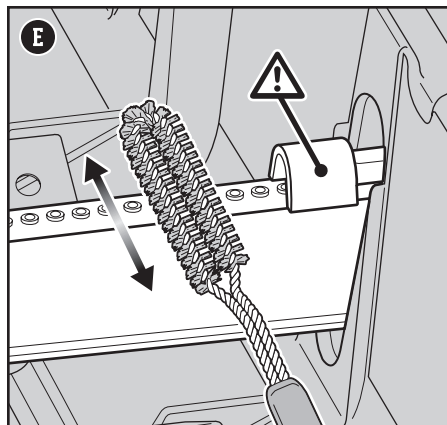
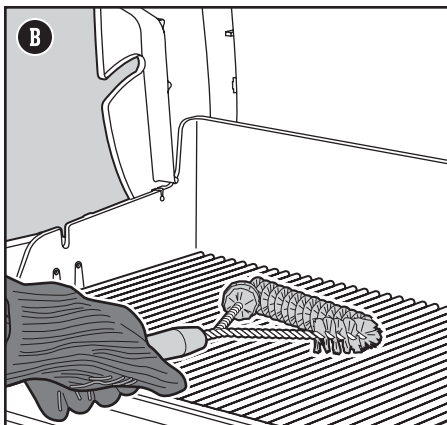
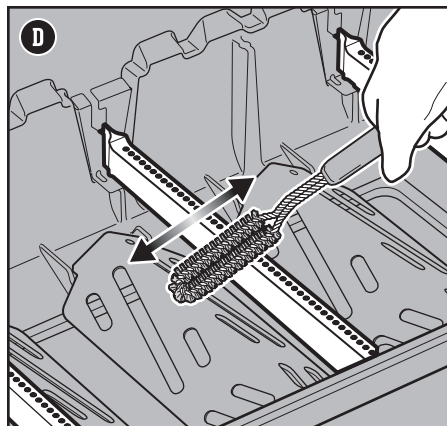
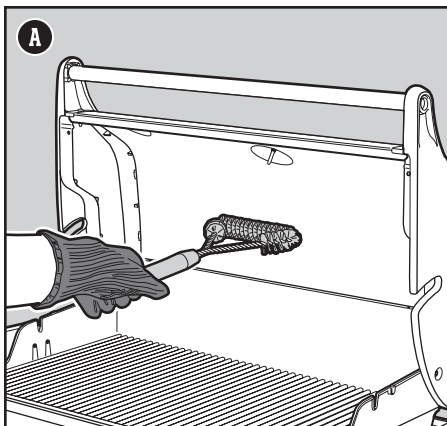

WARNING: Turn your barbecue off and wait for it to cool before thoroughly cleaning.

WARNING: Over time, the development of rough surfaces can form on the FLAVORIZER BARS. Wearing gloves is recommended when handling. Do not clean FLAVORIZER BARS or cooking grates in a sink, dishwasher, or self-cleaning oven.

WARNING: When cleaning the burners, never use a brush that has already been used to clean the cooking grates. Never put sharp objects into the burner port holes.

CAUTION: Do not place any barbecue components onto the side tables as they may scratch the paint or stainless steel surfaces.

CAUTION: Do not use any of the following to clean your barbecue: abrasive stainless steel polishes or paints, cleaners that contain acid, mineral spirits or xylene, oven cleaner, abrasive cleansers (kitchen cleansers), or abrasive cleaning pads.

Cleaning the Heat Deflectors

Located under the burners, the heat deflectors distribute heat evenly throughout the cookbox while cooking. Keeping heat deflectors clean will enhance the cooking performance of your grill.

- 1) Scrape the heat deflectors with a plastic scraper (G).
- 2) If necessary, brush the heat deflectors with a stainless steel bristle grill brush.
- 3) Remove heat deflectors and set aside.

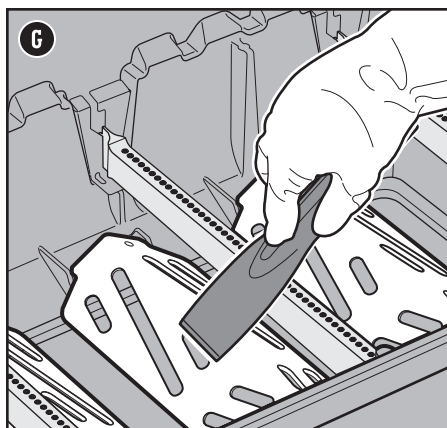

Cleaning the Cookbox

Look inside the cookbox for any grease accumulation or leftover food particles. Excessive accumulation can cause a fire.

- 1) Use a plastic scraper to scrape debris off the sides and bottom of the grill into the opening in the bottom of the cookbox (H). This opening leads debris into the slide-out grease tray.

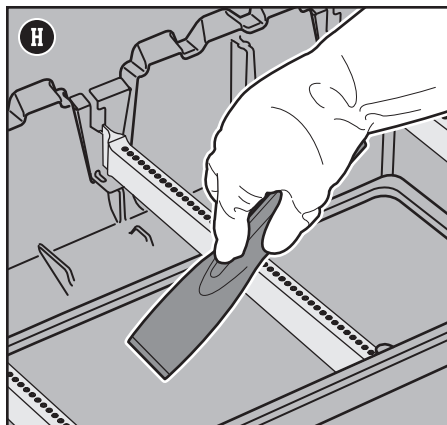

Cleaning the Grease Management System

The grease management system consists of an angled slide-out grease tray and a catch pan. These components were designed to be easily removed, cleaned, and replaced; an essential step every time you prepare to grill. Instructions on inspecting the grease management system can be found in MEAL-TO-MEAL MAINTENANCE.

Cleaning the Outside of the Grill

The outside of your grill may include stainless steel, porcelain-enameled, and plastic surfaces. WEBER recommends the following methods based on the surface type.

Cleaning Stainless Steel Surfaces

Clean stainless steel using a non-toxic, non-abrasive stainless steel cleaner or polish designed for use on outdoor products and grills. Use a microfiber cloth to clean in the direction of the grain of the stainless steel. Do not use paper towels.

Note: Do not risk scratching your stainless steel with abrasive pastes. Pastes do not clean or polish. They will change the colour of the metal by removing the top chromium oxide film coating.

Cleaning Painted, Porcelain-Enameled Surfaces and Plastic Components

Clean painted, porcelain-enameled and plastic components with warm soapy water, and paper towels or cloth. After wiping down the surfaces, rinse and dry thoroughly.

Cleaning the Outside of Grills that are in Unique Environments

If your grill is subject to a particularly harsh environment, you will want to clean the outside more often. Acid rain, pool chemicals, and salt water can cause surface rusting to appear. Wipe down the outside of your grill with warm soapy water. Follow up with a rinse and thorough drying. Additionally, you may want to apply a stainless steel cleaner weekly to prevent surface rust.

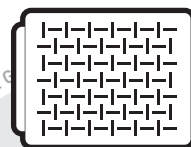

GRILLING PAN

Designed for food that is either too small or too delicate for the cooking grates, a perforated grilling pan keeps food right where it ought to be—on the grill, not in it.

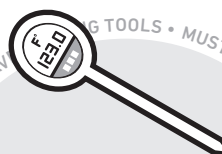

THERMOMETER

Small and relatively inexpensive, this gadget is essential for quickly gauging the internal temperature of the meat when grilling.



GRILL BRUSH

A must-use before you even dream of grilling. A quick once-over on hot grates prevents the charred remains of meals past from sticking to your meals present.

BARBECUE WILL NOT IGNITE

SYMPTOM

• Burner does not ignite when following the electronic ignition instructions in the “Operation” section of this Owner’s Manual.

CAUSE	SOLUTION
There is a problem with gas flow.	If the barbecue will not ignite, the first step is to determine if there is gas flowing to the burners. To check this, follow the instructions below for “Using a Match to Determine if there is Gas Flow to the Burners.” If match lighting IS NOT successful , follow the gas flow troubleshooting suggestions on the next page.
There is a problem with the electronic ignition system.	If the barbecue will not ignite, the first step is to determine if there is gas flowing to the burners. To check this, follow the instructions below for “Using a Match to Determine if there is Gas Flow to the Burners.” If match lighting IS successful , follow the instructions below for “Checking the Components of the Electronic Ignition System.”

Using a Match to Determine if there is Gas Flow to the Burners

- 1) Open the grill lid.
- 2) Check that all burner control knobs are in the off \bigcirc position. Check by pushing in and turning knobs clockwise.
Note: It is important that all burner control knobs be in the off \bigcirc position before you turn on the LPG cylinder.
- 3) Turn gas supply on by turning cylinder valve anti-clockwise or by moving regulator lever to the on position depending on your regulator/cylinder connection.
- 4) Begin with the burner furthest to the left. Put match in the matchstick holder and strike match. (Matchstick holder is located under right side table.) Insert lit match down through the cooking grates, past the FLAVORIZER BARS and next to the burner (A).
- 5) Push the burner control knob in and turn it anti-clockwise to the start/high \bullet position.
- 6) Check that the burner is lit by looking through the cooking grates and through the half-circle cutout in the FLAVORIZER BARS.
- 7) If the burner does not ignite within 4 seconds, turn burner control knob to the off \bigcirc position and wait five minutes to allow the gas to clear before attempting to light the burner again. If repeated attempts fail, follow the gas flow troubleshooting instructions on the next page.
- 8) If the burner ignites, the problem lies in the ignition system. Follow the instructions for “Checking the Components of the Electronic Ignition System”.
- 9) Replace the matchstick holder by hanging underneath right side table (B).

Checking the Components of the Electronic Ignition System

When pressing the ignition button you should hear a ticking sound. If you cannot hear the ticking sound, check the battery, then check the wires.

Checking the Battery

There are three potential issues with the battery that supplies the power to your ignition module that need to be checked:

- 1) Some batteries have a plastic protective wrap around them. (Do not confuse this plastic with the battery label.) Check that this plastic wrap is removed.
- 2) Confirm that the battery is installed correctly (C).
- 3) If the battery is old, replace it with a new battery.

Checking the Wires

There are two potential trouble spots that need to be checked:

- 1) Check that the ignition wires are connected securely to the terminals on the ignition button under the control panel.
- 2) Make sure the ignition wires are properly attached to the ignition module. The wire terminals are colour coded to correspond with the terminals on the ignition module. The number of wires will vary per model.

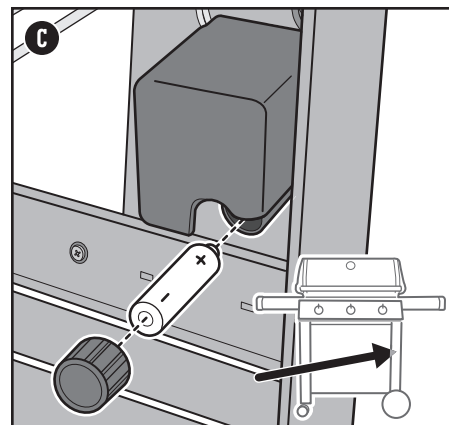
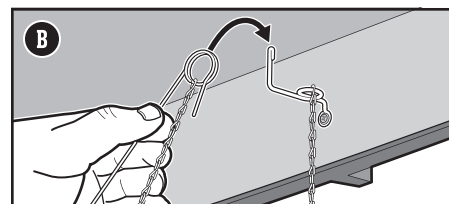
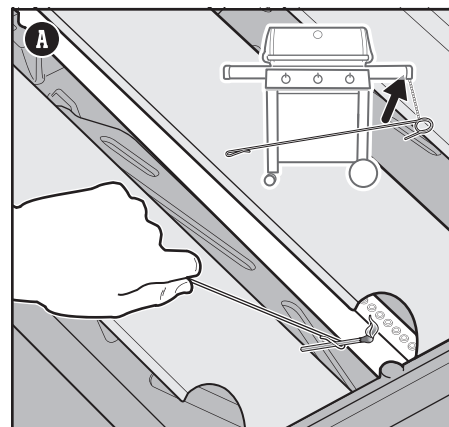

CALL CUSTOMER SERVICE

If you are still experiencing any problems, contact the Customer Service Representative in your area using the contact information on weber.com.

REPLACEMENT PARTS

To obtain replacement parts, contact the local retailer in your area or log onto weber.com.

GAS FLOW

SYMPTOM

- Barbecue does not reach desired temperature or heats unevenly.
- One or more of the burners fail to ignite.
- Flame is low when burner is on high position.
- Flames do not run the whole length of the burner.
- Burner flame pattern is erratic.

CAUSE

SOLUTION

Some countries have regulators with a "flow limiting device" that has been activated. This safety feature built into the regulator restricts the gas flow in the event of a gas leak. You can inadvertently activate this safety feature without having a gas leak. This typically occurs when you turn on the gas at the LPG cylinder and one or more of the control knobs are not in the off position. It may also occur if you turn on the LPG cylinder too quickly.

Reset the "flow limiting device" by closing the LPG cylinder valve and turning all the burner control knobs to the off \bigcirc position. Wait five minutes to allow accumulated gas to dissipate, then ignite the barbecue again following the instructions in the "Operation" section.

The LPG cylinder is low or empty.

Refill LPG cylinder.

Fuel hose is bent or kinked.

Straighten fuel hose.

Burner ports are dirty.

Clean burner ports. Refer to "Cleaning the Burner Ports."

SYMPTOM

- Gas is smelled in conjunction with burner flames that appear yellow and lazy.

CAUSE

SOLUTION

Spider screens on the burners are obstructed.

Clean spider screens. Refer to "Cleaning the Spider Screens" in the Product Care section. Also refer to the illustrations and information in this section about proper flame pattern and spider screens.

SYMPTOM

- The smell of gas and/or a light hissing sound.

CAUSE

SOLUTION

The internal rubber seal in the LPG cylinder valve could be damaged.

Inspect the rubber seal for damage. If damaged, return LPG cylinder to local retailer.

GREASY BARBECUE (Peeling Paint & Flare-Ups)

SYMPTOM

- Inside of lid appears to have the appearance of peeling paint.

CAUSE

SOLUTION

The flakes you see are accumulated cooking vapours that have turned into carbon.

This happens over time after repeated use of your barbecue. This is not a defect. Clean the lid. Refer to the "Product Care" section.

SYMPTOM

- Experiencing flare-ups when barbecuing or preheating.

CAUSE

SOLUTION

There is leftover food from the previous meal.

Always preheat the barbecue on the highest setting for 10 to 15 minutes.

The inside of the barbecue needs to be cleaned thoroughly.

Follow the steps in the "Cleaning and Maintenance" section to clean the barbecue inside from the top down.

Proper Burner Flame Pattern

The burners in your grill were factory set for the correct air and gas mixture. When the burners are performing correctly, you will see a specific flame pattern. The tips may occasionally flicker yellow (A), with a descending light blue (B) to dark blue flame (C).

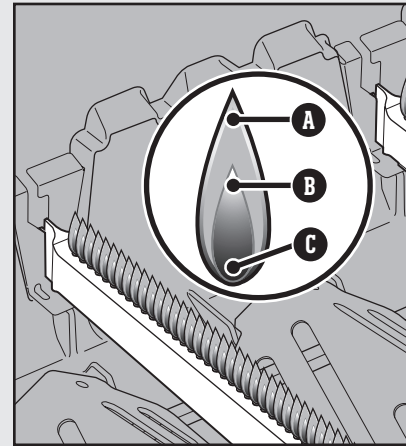

Spider Screens

The combustion air openings of the burners (D) are fitted with stainless steel screens to prevent spiders and other insects from spinning webs and building nests inside the burners. Additionally, dust and debris can accumulate on the outside of the spider/insect screen and obstruct the oxygen flow to the burners.

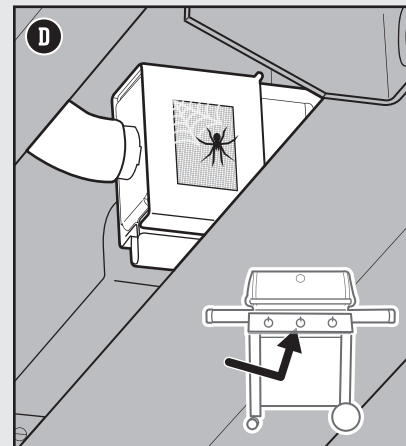





⚠ WARNING: Do not attempt to make any repair to gas carrying, gas burning, ignition components or structural components without contacting Weber-Stephen Products LLC, Customer Service Department.

⚠ WARNING: Failure to use genuine Weber-Stephen parts for any repair or replacement will void all warranty protection.

⚠ CAUTION: The burner tube openings must be positioned properly over the valve orifices.

Barbecuing Guide

Type	Thickness/Weight	Approximate Total Barbecue Time
 RED MEAT		
Steak: New York strip, porterhouse, rib-eye, T-bone, and filet mignon (tenderloin)	19 mm thick	4 to 6 minutes direct high heat
	25 mm thick	6 to 8 minutes direct high heat
	50 mm thick	14 to 18 minutes sear 6 to 8 minutes direct high heat, then 8 to 10 minutes indirect high heat
Flank Steak	0.68 to 0.90 kg, 19 mm thick	8 to 10 minutes direct medium heat
Ground Beef Patty	19 mm thick	8 to 10 minutes direct medium heat
Tenderloin	1.3 to 1.8 kg	45 to 60 minutes 15 minutes direct medium heat, then 30 to 45 minutes indirect medium heat
 PORK		
Bratwurst: fresh	85 g link	20 to 25 minutes direct low heat
Chop: boneless or bone in	19 mm thick	6 to 8 minutes direct high heat
	31 to 38 mm thick	10 to 12 minutes sear 6 minutes direct high heat, then 4 to 6 minutes indirect high heat
Ribs: baby back, spareribs	1.3 to 1.8 kg	1½ to 2 hours indirect medium heat
Ribs: country-style, bone in	1.3 to 1.8 kg	1½ to 2 hours indirect medium heat
Tenderloin	0.454 kg	30 minutes sear 5 minutes direct high heat, then 25 minutes indirect medium heat
 POULTRY		
Chicken Breast: boneless, skinless	170 to 226 g	8 to 12 minutes direct medium heat
Chicken Thigh: boneless, skinless	113 g	8 to 10 minutes direct medium heat
Chicken Pieces: bone in, assorted	85 to 170 g	36 to 40 minutes 6 to 10 minutes direct low heat, then 30 minutes indirect medium heat
Chicken: whole	1.8 - 2.2 kg	1 to 1¼ hours indirect medium heat
Cornish Game Hen	0.68 - 0.90 kg	60 to 70 minutes indirect medium heat
Turkey: whole, unstuffed	4.5 - 5.4 kg	2 to 2½ hours indirect medium heat
 SEAFOOD		
Fish, Fillet, or Steak: halibut, red snapper, salmon, sea bass, swordfish, and tuna	6.3 to 12.7 mm thick	3 to 5 minutes direct medium heat
	25 - 31 mm thick	10 to 12 minutes direct medium heat
Fish: whole	0.454 kg	15 to 20 minutes indirect medium heat
	1.36 kg	30 to 45 minutes indirect medium heat
Shrimp	42.5 g	2 to 4 minutes direct high heat
 VEGETABLES		
Asparagus	12.7 mm in diameter	6 to 8 minutes direct medium heat
	in husk	25 to 30 minutes direct medium heat
Corn	husk removed	10 to 15 minutes direct medium heat
	shiitake or button	8 to 10 minutes direct medium heat
Mushroom	portobello	10 to 15 minutes direct medium heat
	halved	35 to 40 minutes indirect medium heat
Onion	12.7 mm slices	8 to 12 minutes direct medium heat
	whole	45 to 60 minutes indirect medium heat
Potato	12.7 mm slices	9 to 11 minutes parboil 3 minutes, then 6 to 8 minutes direct medium heat

The cuts, thicknesses, weights, and barbecuing times above are meant to be guidelines. Factors such as altitude, wind, and outside temperature can affect cooking times. Two rules of thumb: Barbecue steaks, fish fillets, boneless chicken pieces, and vegetables using the direct method for the time given on the chart (or to the desired doneness), turning food once halfway through barbecuing time. Barbecue roasts, whole poultry, bone-in poultry pieces, whole fish and thicker cuts using the indirect method for the time given on the chart (or until an instant-read thermometer registers the desired internal temperature). Cooking times for beef and lamb are to medium doneness unless otherwise noted. Before carving, let roasts, larger cuts of meat, and thick chops and steaks rest for 5 to 10 minutes after cooking. The internal temperature of the meat will rise by 5 to 10 degrees during this time.



GENESIS II E-210 GBS

GENESIS II_E210 wGBS_LP_CL_110117

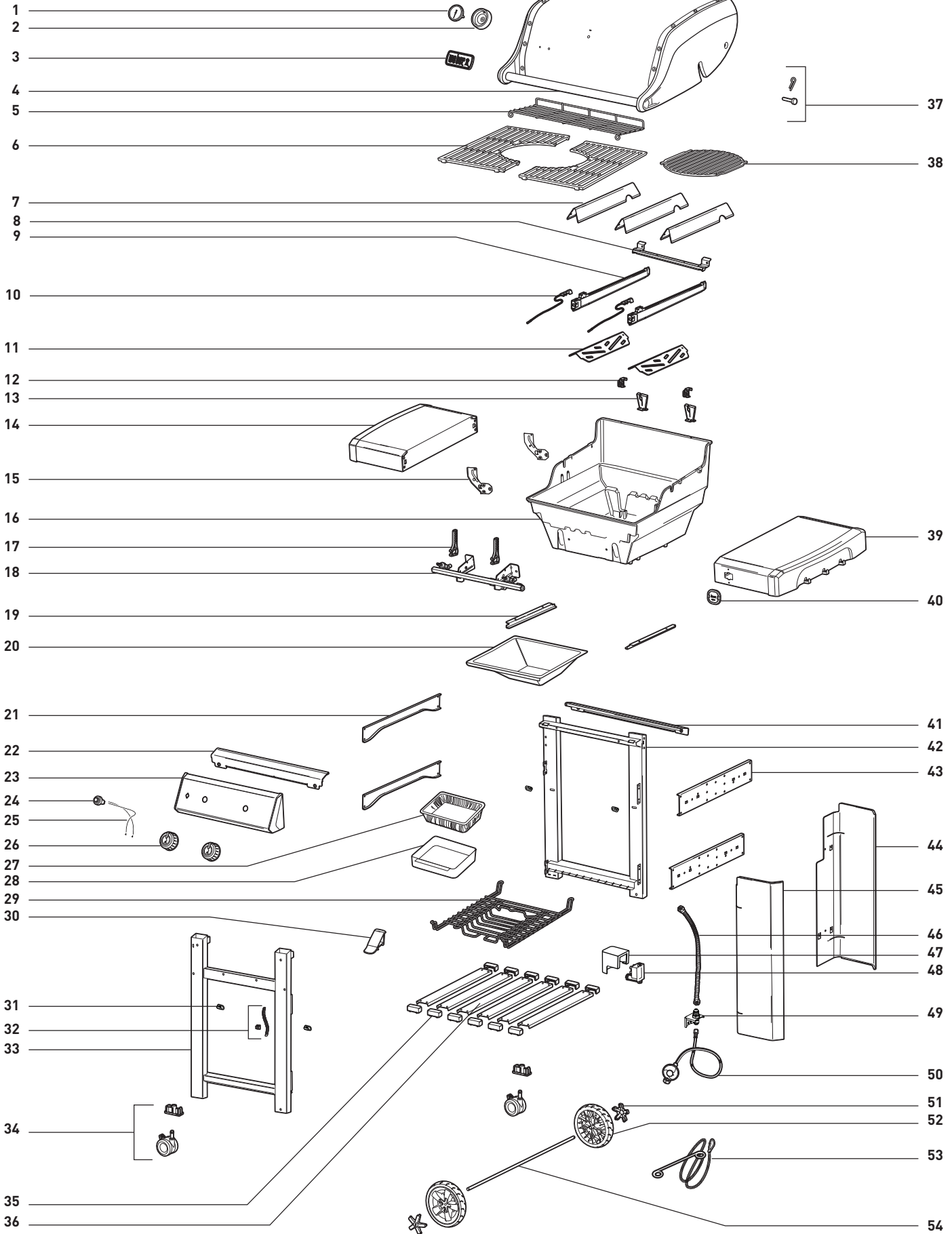

Replacement Parts

GENESIS II E-310 GBS

GENESIS II_E310_wGBS_LP_CL_110117

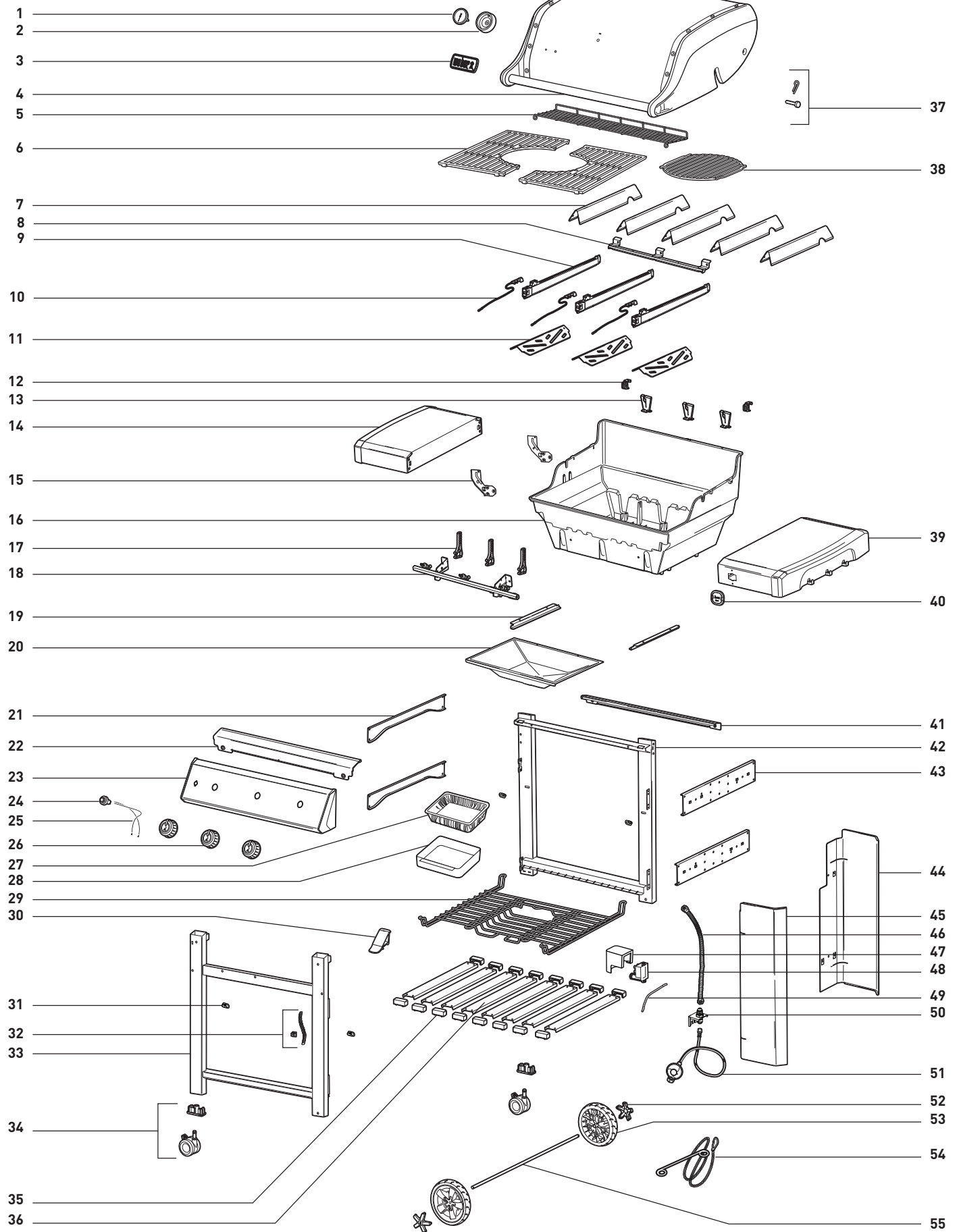

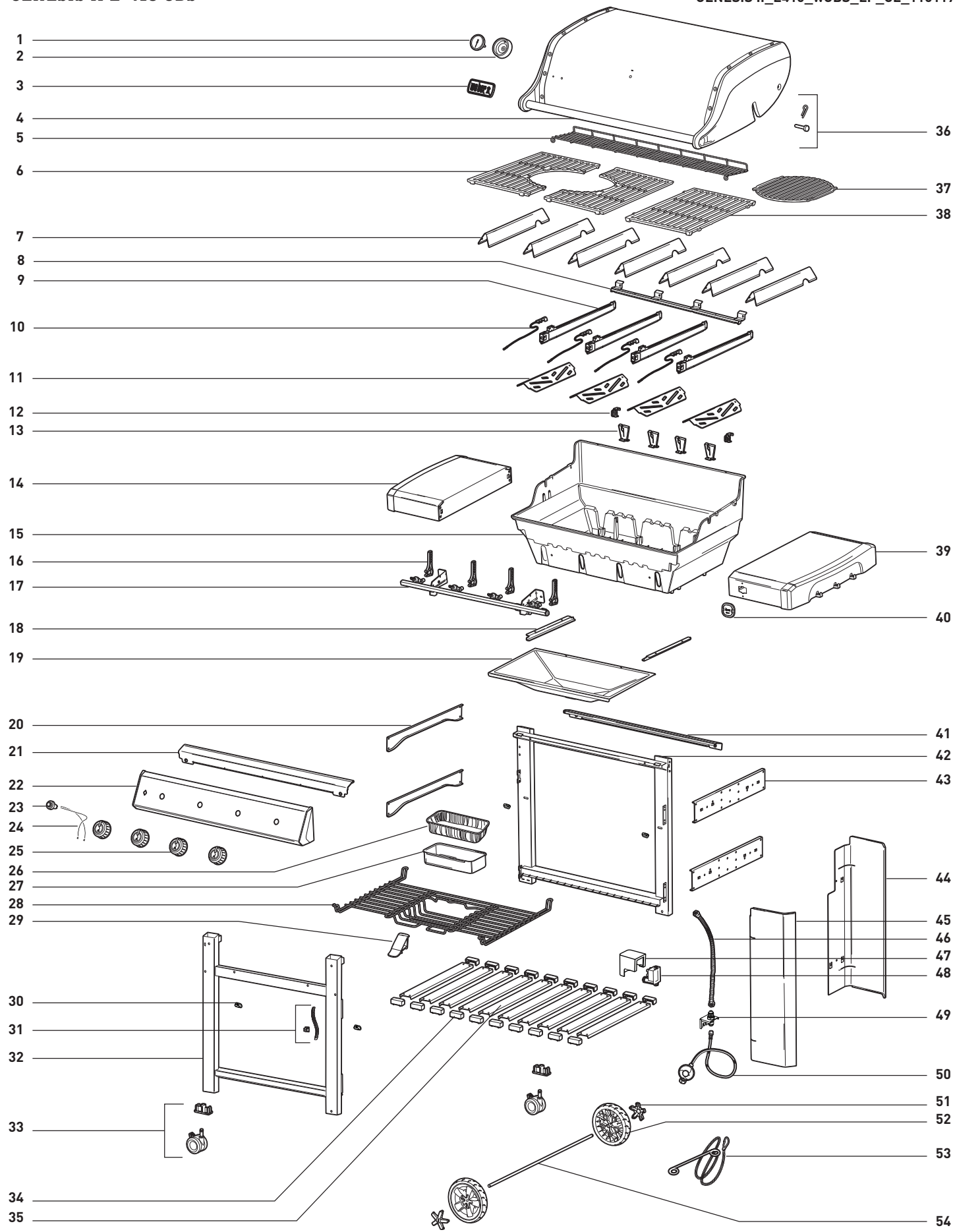



A series of horizontal dotted lines spanning the width of the page, intended for writing or drawing.



WEBER ACCESSORIES

Essential tools and cookware to get the most out of your grilling experience.

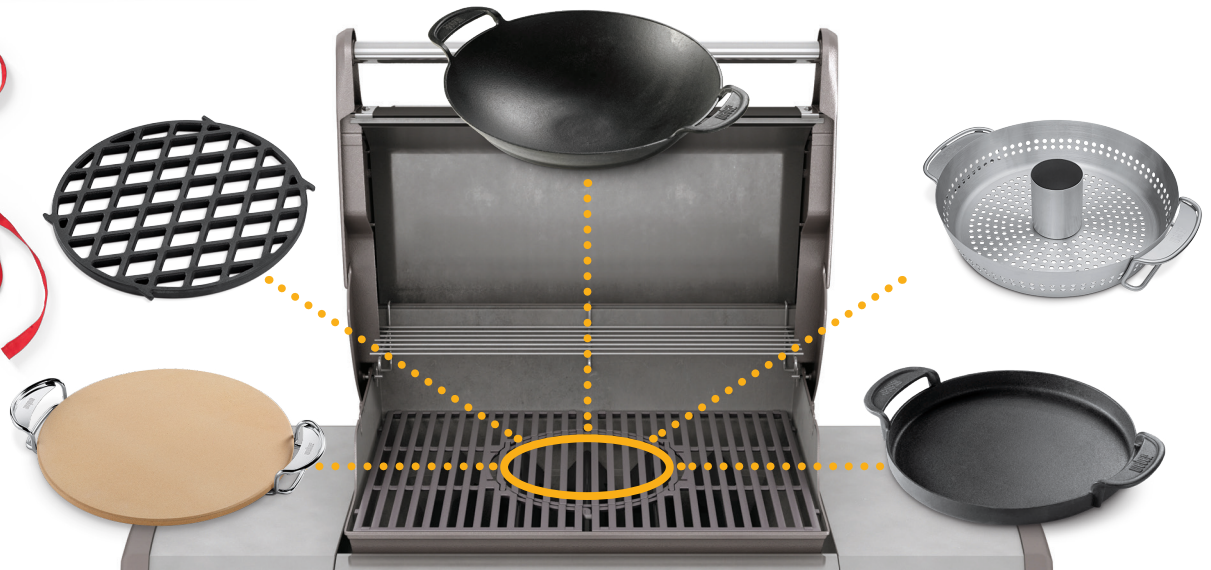

weber.com



Serial Number

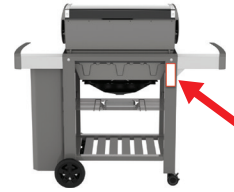

Write your grill's serial number in the above box for future reference. The serial number is on the data label located on the back, right-hand side of the grill frame.

AUSTRALIA

Weber-Stephen Products LLC
R. McDonald Co. PTY. LTD.
+61.8.8221.6111

AUSTRIA

Weber-Stephen Österreich GmbH
+43 7242 890 135 0
info-at@weberstephen.com

BELGIUM

Weber-Stephen Products Belgium Sprl
+32 015 28 30 90
infobelux@weberstephen.com

CHILE

Weber-Stephen Chile SpA.
+01 56 2-3224-3936

CZECH REPUBLIC

Weber-Stephen CZ & SK spol. s r.o.
+42 267 312 973
info-cz@weberstephen.com

DENMARK

Weber-Stephen Nordic ApS
+45 99 36 30 10
info@weberstephen.dk

FRANCE

Weber-Stephen France
+33 810 19 32 37
service.consommateurs@weberstephen.com

GERMANY

Weber-Stephen Deutschland GmbH
+49 6132 8999 0
info-de@weberstephen.com

HUNGARY

Weber-Stephen Magyarország Kft.
+36 70 / 70-89-813
info-hu@weberstephen.com

ICELAND

Jarn & Gler Wholesale EHF
+354 58 58 900

INDIA

Weber-Stephen Barbecue Products India Pvt. Ltd.
080 42406666
customercare@weberindia.com

ISRAEL

D&S Imports
+972 392 41119
info@weber.co.il

ITALY

Weber-Stephen Products Italia Srl
+39 0444 360 590
info-italia@weberstephen.com

MEXICO

Weber-Stephen Products S.A. de C.V.
+01800-00-WEBER [93237] Ext. 105

NETHERLANDS

Weber-Stephen Netherlands B.V.
+31 513 4333 22
info@weberbarbecues.nl

NEW ZEALAND

WEBER New Zealand ULC
+64 9 570 6630

POLAND

Weber-Stephen Polska Sp. z o.o.
+48 22 392 04 69
info-pl@weberstephen.com

RUSSIA

Weber-Stephen Vostok LTD.
+7 495 956 63 21
info.ru@weberstephen.com

SOUTH AFRICA

Weber-Stephen Products (South Africa) (Pty) Ltd.
+27 11 454 2369
info@weber.co.za

SPAIN

Weber-Stephen Iberica Srl
+34 93 584 40 55
infoiberica@weberstephen.com

SWITZERLAND

Weber-Stephen Schweiz GmbH
+41 52 24402 50
info-ch@weberstephen.com

TURKEY

Dost Bahçe Dis Ticaret Müessillik Anonim Sirketi
+49 6132 8999 0
info-de@weberstephen.com

UNITED ARAB EMIRATES

Weber-Stephen Nordic Middle East
+971 4 360 9256
info@weberstephen.ae

UNITED KINGDOM

Weber-Stephen Products (UK) Ltd.
+44 (0)203 630 1500
customerserviceuk@weberstephen.com

USA

Weber-Stephen Products LLC
847 934 5700
support@weberstephen.com

For Republic of Ireland, please contact:
Weber-Stephen Products (U.K.) Limited.

For other eastern European countries, such as ROMANIA,
SLOVENIA, CROATIA, or GREECE, please contact:
Weber-Stephen Deutschland GmbH.

For Baltic states, please contact:
Weber-Stephen Nordic ApS.

weber.com

