

# AVVL24DMXWA - 2 Ton

## GE Zoneline Heat Pump, Single Package Vertical Air Conditioner, 230-208 Volt

Features	
Inverter Driven, Variable Speed Compressor	
Make Up Air	
Ultra-Low Heat Pump Operation (Down to 0 deg F)	
Insta-Platform™ (Sold Separately)	
Self-Contained Drainage System	
Fast-Connect Plumbing	
Quick Install Plenum (Sold Separately)	
Self-Aligning, Lock in Place System	
Onboard Diagnostics	
Rustproof Bulkhead and Base Pan	
Ultra-Quiet	
Smart HQ® Wi-Fi Ready (Requires Subscription)	



Lowest global warming refrigerant in its class

Warranty	
Parts Warranty	Limited 5-year
Labor Warranty	Limited 1-year entire appliance Limited 5-year sealed system
Warranty Notes	See written warranty for full details

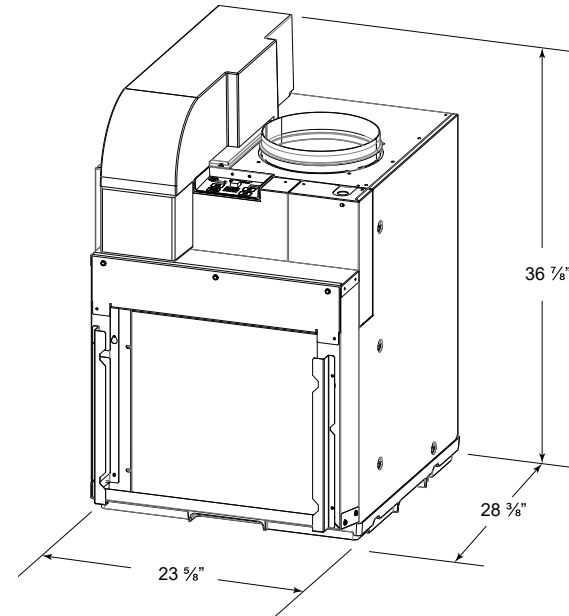

Performance Data at 230-208V	
Rated Cooling BTU:	22,400 BTU
Cooling BTU Range @95F:	5,000 -24,000 BTU
EER2:	8.9
SEER2:	16.0
Rated Heat Pump BTU:	21,500 BTU
Heating BTU Range @47F:	5,000 - 23,000 BTU
Heat Pump COP2@47F:	2.8
HSPF2:	7.6
Make Up Air CFM Range:	30-70 (no filter), 25-70 (with MERV13 Filter Kit)

### POWER CONNECTION REQUIREMENTS (RESISTANCE HEAT)

230-208 VOLT	12,000 BTU/h	
	POWER CONNECTION KIT**	RAK320D
Heater BTU/h	11,770 / 9,629	17,060 / 13,952
Total Watts	3,568 / 2,940	5,118 / 4,207
Heater Watts	3,450 / 2,822	5,000 / 4,089
Total Heating Amps	15 / 13.6	21.7 / 19.7
MCA	20	30
Recommend Protective Device (MOCP)	20 amp time delay fuse or breaker	30 amp time delay fuse or breaker

\*230V Performance Data Listed

\*\* 15 Amp power connection not available for 2-ton models

Note: It is recommended to leave additional space around the unit to ease installation and access for service.

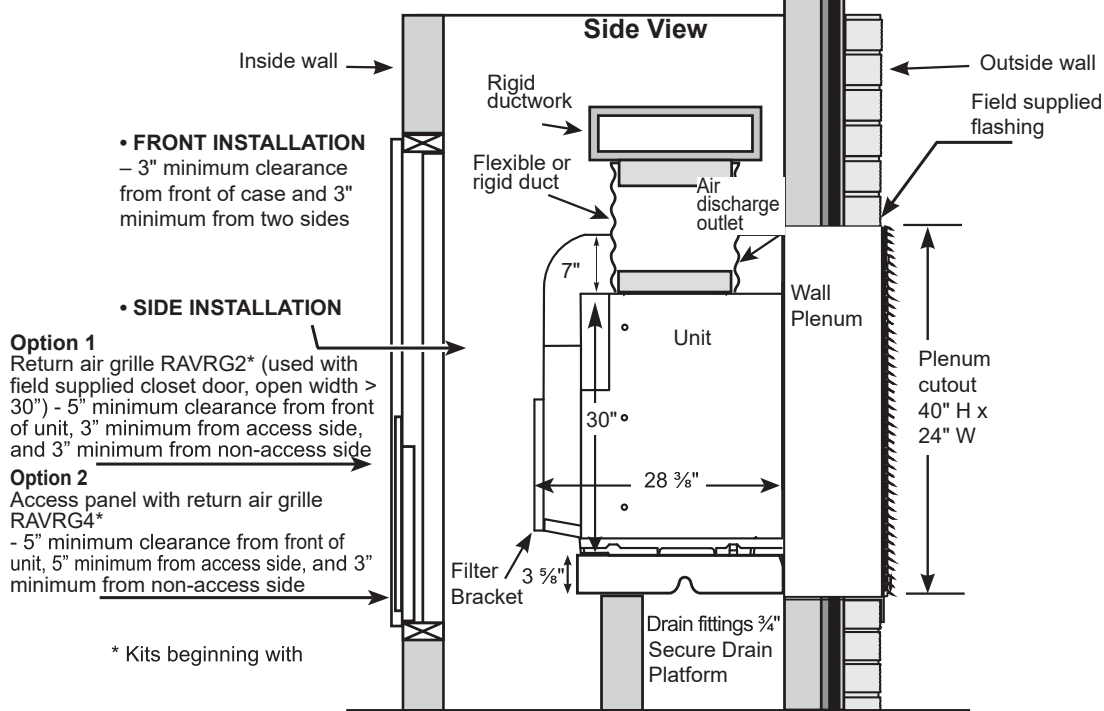

### SIDE INSTALL Option 1 (RAVRG2\* in Door or closet wall)

Top View

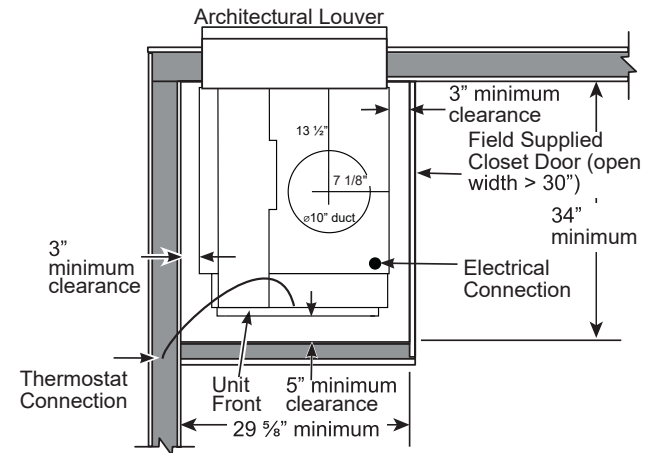

### SIDE INSTALL Option 2 (RAVRG4\*)

Top View

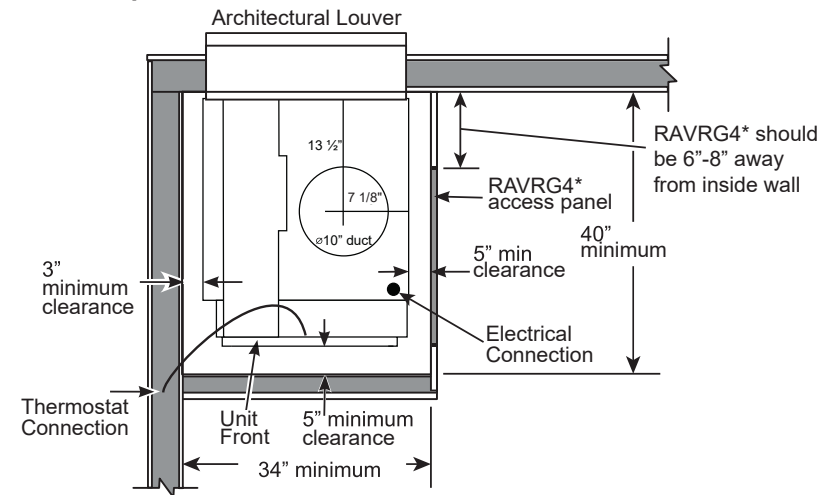

For RAVRG4\*: After installing RAVDPLAT per instructions, slide rear of unit through RAVRG4\* and rest it on platform in the closet. Rotate unit 90° so that rear of unit is facing the wall plenum. Follow remaining instructions for installing unit to wall plenum.

### FRONT INSTALL

Top View

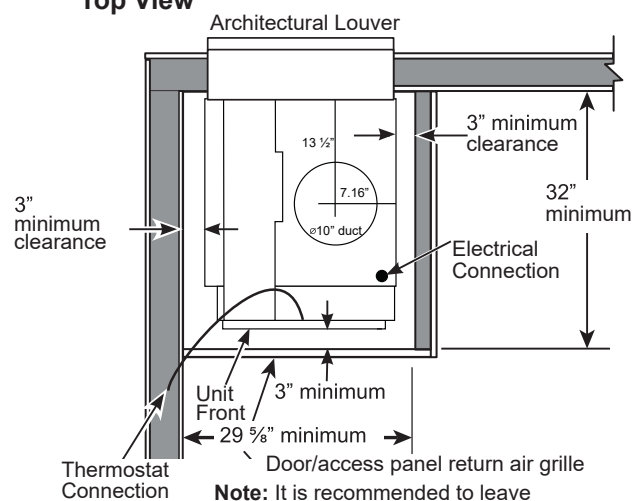

**Note:** It is recommended to leave additional space around the unit to ease installation and access for service.

# ACCESSORIES for NEW Installation

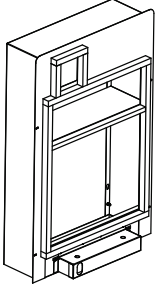
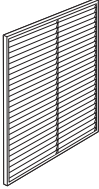
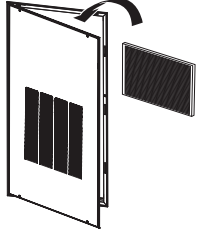
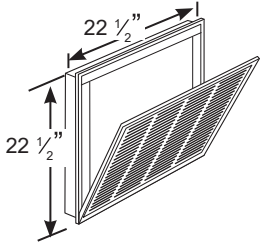
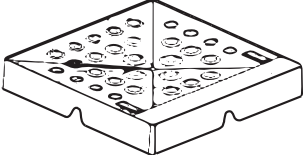
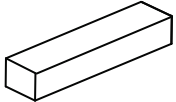
Accessory and model number	Appearance	Cutout Dimensions
<b>Plenum (telescoping)</b> RAVWPT15B 8"-15"D x 23 <sup>3</sup> / <sub>4</sub> "W x 39 <sup>3</sup> / <sub>4</sub> "H *excluding flange		Cutout Dimensions: 24"W x 40"H
<b>Architectural Louver</b> RAVAL4		Architectural Louver designed to fit the following Plenums: RAVWPT15B 8"-15"D x 23 <sup>3</sup> / <sub>4</sub> "W x 39 <sup>3</sup> / <sub>4</sub> "H
<b>Access Panel with Return Air                      Grille (optional)</b> RAVRG4*		Cutout Dimensions: 28 <sup>1</sup> / <sub>8</sub> "W x 55 <sup>7</sup> / <sub>8</sub> "H
<b>Return Air Grille (optional)</b> RAVRG2*		Cutout Dimensions: 20 <sup>3</sup> / <sub>8</sub> "W x 20 <sup>3</sup> / <sub>8</sub> "H
<b>Drain Platform</b> RAVDPLAT		Not Applicable
<b>MUA filter (optional)</b> RAA13V		Not applicable

## Power Connection Required – Direct Connect

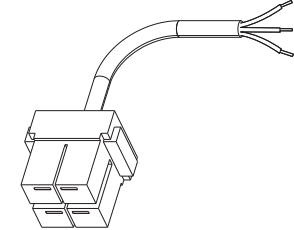

### Options:

**RAK320D – 230/208V, 20 Amp**

**RAK330D – 230/208V, 30 Amp**

**Note: See page 1 for Electrical Data**

## Wall Thermostat (appearance may vary)

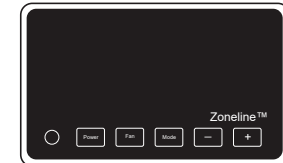

Options	Communication Type
RAK190V	Two Way, 4 wire
RAK150VF2	Standard, 8-wire

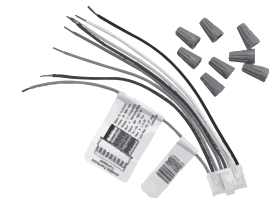

Optional Zoneline thermostat connector kit  
 for non-GE Appliances wall thermostats:  
 RAKTK8W1 - 8 pin / 8 wire (1 pack)  
 RAKTK8W10 - 8 pin / 8 wire (10 pack)