

BM30URXI



Product family	Refrigerator
Installation	Freestanding
Category	Bottom mount
No-frost system	Total
Cooling type	Total no-frost - Dual-flow cooling system
Defrost	Automatic
Hinge	Standard
Hinge position	Right
Counter-depth	Yes
EAN code	8017709344030



Aesthetic



Aesthetics	SPR	Side material	Steel
Color	Stainless steel	Side color	Steel
Material	Steel	Logo	Applied
Door stainless steel type	Normal	Door shelf profile color	Silver
Handle	External	Drawers profile color	Silver
Handle	Fixed	Glass shelf profile color	Silver
Handle color	Stainless steel	Display	LED
Logo color	Stainless steel	Display position	Internal

Refrigerator compartment features



Number of compartments	3	Crisper cover	Yes
Compartment types	Low temperature compartment, Fruit and vegetable compartment	Type of crisper cover	Glass
No. of adjustable shelves	2	No. of lights	1
Number of fruit and vegetables drawers	2	Low temperature compartment	Yes
Shelves material	Glass	Refrigerator lighting	Yes
Crisper drawer type	Standard	Refrigerator lighting	LED

Refrigerator Inner Door

Number of adjustable door shelves 4

No. of bottle shelves 1

Other Refrigerator features



Humidity Control Yes
MultiFlow Yes

Fan Yes

Freezer features

Number of drawers 2
No. of lights 2
Freezer lighting Yes

Freezer lighting LED
Shelf type Glass

Other Freezer features

Accessories 1 x ice box
Ice maker Automatic

Daily ice production 3 lbs
Ice shape Cubes

Other technical features



Display functions
Fast-freezing button
Water network connection
Power-on light
Temperature alarm
Door open alarm
Temperature setting type
No. of compressors
Refrigerant gas type
Compressor type
No. of evaporators
Foam agent

Holiday, Fast-freezing, Sabbath
Yes
Yes
Yes
Yes
Yes
Electronic
1
R600a
Inverter
2
Cyclopentane

Performance / Energy Label

Total net volume 16.1 cu. ft.
Freezer volume 5.2 cu. ft.
Refrigerator volume 10.9 cu. ft.

Freezer capacity 5.8 cu. ft.
Refrigerator volume 11.7 cu. ft.

Electrical Connection







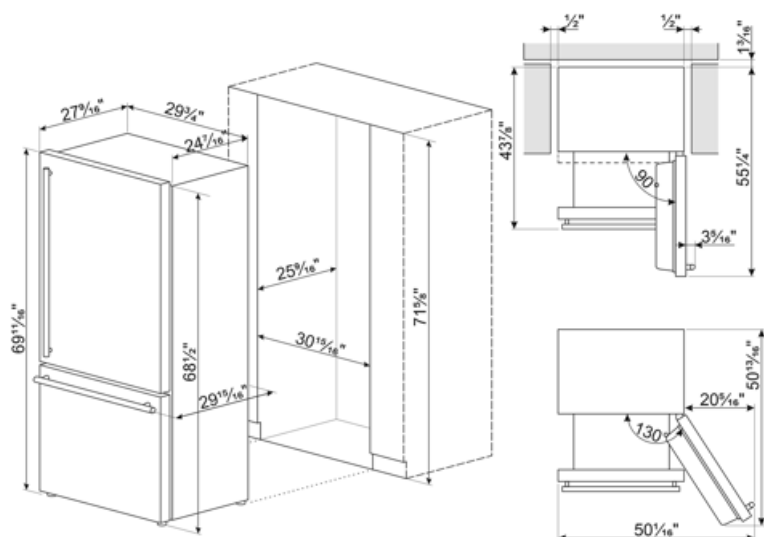

Electrical connection rating	200 W	Frequency (Hz)	60 Hz
Current	2 A	Power cord length	83 1/16 "
Voltage (V)	120 V	Plug	(B) NEMA 5-15P

Logistic Information

Width	29 3/4 "	Width with doors open at 90°	49 15/16 "
Depth without handle	27 9/16 "	Product depth (handle included)	29 13/16 "
Height	68 1/2 "	Depth with door open at 90°	55 1/4 "



Symbols glossary

- | | | | |
|--|---|---|---|
|  | The automatic defrost system works by automatically defrosting at regular intervals eliminating the need to defrost altogether. |  | LED display: to show programmes, functions and options selected and the time to the end of the cycle. |
|  | Ventilated: Forced distribution of cold air in the refrigerator compartment, which allows even temperature distribution within the fridge. |  | Fast freezing: The fast freezing function brings the temperature of the compartment down when activated a few hours prior to usage. |
|  | Power saving mode: The power saving mode allows you to disable the refrigerator and keep the freezer working. |  | LED interior lighting: is a more energy efficient and long lasting way of illuminating the interior of the appliance. |
|  | Inverter technology: The evolution of Smeg's driers towards more intelligent and environmentally sustainable models has led to the choice of using Inverter technology with heat pumps, which reduces significantly energy consumption. |  | Air plus: keeps food fresher for longer. |
|  | Sabbath: This function allows you to cook food during the Sabbath, the Holiday of rest in the Jewish religion, respecting the precepts. | | |