

CB2485U



Product family	Refrigerator
Installation	Built-in
Category	Bottom mount
No-frost system	Total
Cooling type	Fan-assisted refrigerator, no-frost freezer
Defrost	Automatic
Hinge	Door-to-door
Hinge position	Right
Reversible door	Yes
EAN code	8017709306045



Aesthetic



Material	Steel	Glass shelf profile color	Silver
Side material	Steel	Display	LED
Logo	Silkscreened	Display position	Internal
Door shelf profile color	Silver		

Refrigerator compartment features



No. of adjustable shelves	3	Low temperature compartment	Yes
Number of fruit and vegetables drawers	2	Refrigerator lighting	Yes
Type of adjustable shelves	Glass	Refrigerator lighting	LED
Crisper cover	Yes		

Refrigerator Inner Door

Number of adjustable door shelves	2	No. of bottle shelves	1
--	---	------------------------------	---

Other Refrigerator features



Accessories	Egg tray	Fan	Yes
-------------	----------	-----	-----

Freezer features

Number of drawers	3
-------------------	---

Other Freezer features



Accessories	1 x ice box	Fast-freezing compartment	Yes
-------------	-------------	---------------------------	-----

Other technical features



Display functions	Holiday, Fast-freezing, Fast-cooling, ECO
Fast-freezing button	Yes
Power-on light	Yes
Door open alarm	Yes
Temperature setting type	Electronic
No. of compressors	1
Refrigerant gas type	R600a
Foam agent	Cyclopentane

Performance / Energy Label







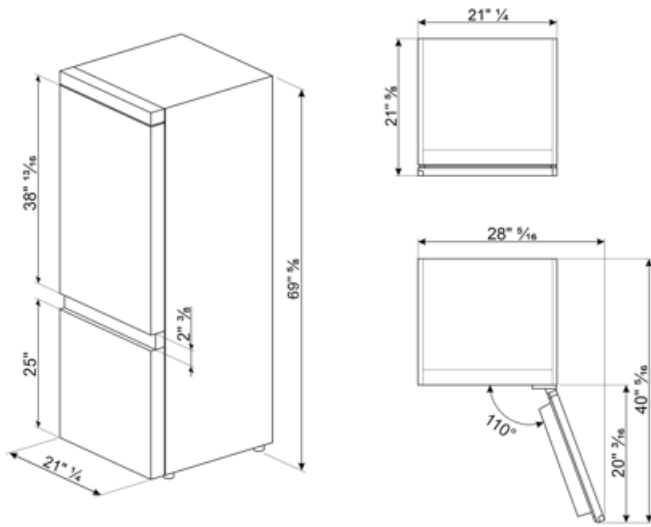

Noise level	40 dB(A) re 1 pW
-------------	------------------

Electrical Connection

Plug	(A) USA & Mexico	Voltage (V)	115 V
Electrical connection rating	160 W	Frequency (Hz)	60 Hz
Current	0,4 A	Power cord length	70 7/8 "



Symbols glossary (TT)

	The automatic defrost system works by automatically defrosting at regular intervals eliminating the need to defrost altogether.		LED display: to show programmes, functions and options selected and the time to the end of the cycle.
	Economical mode: Analyzes fridge functioning during the activation and optimizes the operating cycle in order to reduce power consumption.		Ventilated: Forced distribution of cold air in the refrigerator compartment, which allows even temperature distribution within the fridge.
	Fast freezing: The fast freezing function brings the temperature of the compartment down when activated a few hours prior to usage.		Power saving mode: The power saving mode allows you to disable the refrigerator and keep the freezer working.
	LED interior lighting: is a more energy efficient and long lasting way of illuminating the interior of the appliance.		No Frost: The No Frost and Frost free systems prevent ice from forming so that no defrosting is required.