

CB465UI



Product family	Refrigerator
Installation	Built-in
Category	Bottom mount
No-frost system	Total
Cooling type	Total no-frost - Dual-flow cooling system
Defrost	Automatic
Hinge	Door-to-door
Kitchen panel	Not supplied
Hinge position	Right
Reversible door	Yes
EAN code	8017709313739



Aesthetic

Aesthetics	Universal	Glass shelf profile color	White
Handle	Not included	Display	TFT
Side material	Steel	Display position	Internal (belt-line)
Logo	Silkscreened	Dispenser	Ice and water
Door shelf profile color	Silver	Water filter	Internal
Drawers profile color	Silver		

Refrigerator compartment features



No. of adjustable shelves	2	Type of crisper cover	Glass
Number of fruit and vegetables drawers	1	No. of lights	3
Type of adjustable shelves	Glass	Convertible temperature drawer	Yes
Crisper drawer type	Standard	Refrigerator lighting	Yes
Crisper cover	Yes	Refrigerator lighting	LED

Refrigerator Inner Door

Number of adjustable door shelves	2	No. of bottle shelves	1
--	---	------------------------------	---

Other Refrigerator features



MultiFlow Yes

Freezer features

Number of drawers 1

Other Freezer features



Ice maker	Automatic	Ice-tray shelf	Yes
Fast-freezing compartment	Yes		

Other technical features

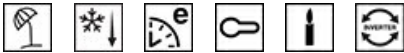

Display functions	Holiday, Fast-freezing, Fast-cooling, ECO, Child lock, Temperature alarm, Sabbath
Fast-freezing button	Yes
Water network connection	Yes
Power-on light	Yes
Temperature alarm	Yes
Door open alarm	Yes
Temperature setting type	Electronic
No. of compressors	1
Refrigerant gas type	R600a
Compressor type	Inverter
Foam agent	Cyclopentane

Performance / Energy Label

Noise level 44 dB(A) re 1 pW

Electrical Connection



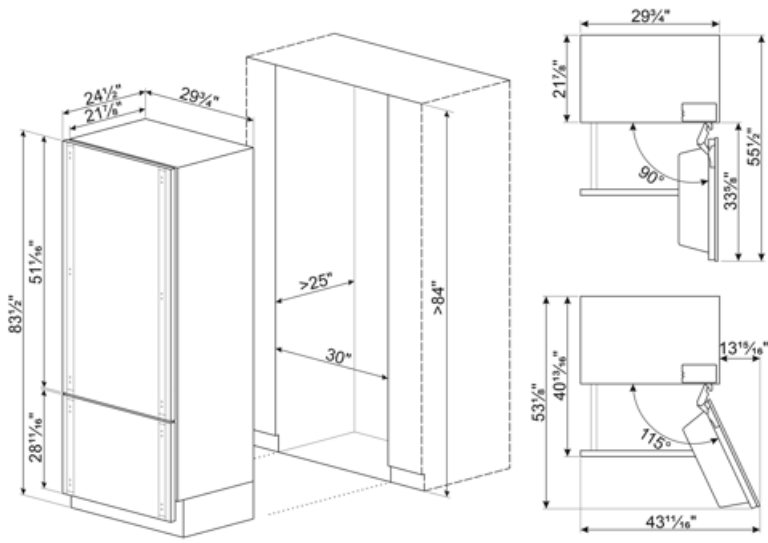





Plug	(A) USA & Mexico	Voltage (V)	120 V
Current	2 A	Frequency (Hz)	60 Hz



Not included accessories

KIT465H

Symbols glossary (TT)

- | | | | |
|--|---|---|---|
|  | The automatic defrost system works by automatically defrosting at regular intervals eliminating the need to defrost altogether. |  | Child lock: some models are fitted with a device to lock the programme/cycle so it cannot be accidentally changed. |
|  | Economical mode: Analyzes fridge functioning during the activation and optimizes the operating cycle in order to reduce power consumption. |  | Fast freezing: The fast freezing function brings the temperature of the compartment down when activated a few hours prior to usage. |
|  | Power saving mode: The power saving mode allows you to disable the refrigerator and keep the freezer working. |  | LED interior lighting: is a more energy efficient and long lasting way of illuminating the interior of the appliance. |
|  | Inverter technology: The evolution of Smeg's driers towards more intelligent and environmentally sustainable models has led to the choice of using Inverter technology with heat pumps, which reduces significantly energy consumption. |  | Air plus: keeps food fresher for longer. |
|  | Sabbath: This function allows you to cook food during the Sabbath, the Holiday of rest in the Jewish religion, respecting the precepts. The oven works | | |