

CPF30UGGR

Range size	30"
N. of cavities with energy label	1
Oven energy source	Gas
Main oven	Gas with grill
EAN code	8017709270322



Aesthetic



Aesthetics	Portofino	Controls color	Stainless steel
Design	Flush mounted	No. of controls	7
Color	Red	Silkscreen color	Black
Control panel finish	Metal enameled	Display	Touch
Logo	Stainless steel	Door	With frame
Logo position	Fascia below the oven	Door glass type	Gray
Upstand	Yes	Handle	Portofino
Cooktop color	Stainless steel	Handle color	Colored
Grates	Cast Iron	Storage compartment	Storage drawer
Control setting type	Control knobs	Feet	Stainless steel
Control knobs	Portofino	Plinth	Black

Programs / Functions

No. of cooking functions	3
Traditional cooking functions	



Large grill



Bottom



Convection bottom

Cooktop technical features



Cooking zones 4

Left - Gas - Dual ultra-rapid - 5860 W - 20000 BTU

Front-center - Gas - Semi-rapid - 2340 W - 8000 BTU

Rear-center - AUX - 1310 W - 4500 BTU

Right - Gas - Ultra-rapid - 5860 W - 20000 BTU

Burners type	Standard	Gas safety valves	Yes
Automatic gas ignition	Yes	Burner caps	Enameled matte black

Main Oven Technical Features



No. of lights	2	Removable door	Yes
Fan number	1	Full-glass inner door	Yes
Volume	0.13 cu. ft.	Removable inner door	Yes
Cavity material	EverClean enamel	Total no. of door glasses	3
No. of shelves	4	No. of thermo-reflective door glasses	2
Shelves type	Metal racks	Safety thermostat	Yes
Light type	Halogen	Cooling system	Tangential
Light Power	40 W	Inner cavity dimensions (HxWxD)	317 x 640 x 430 "
Time setting	Start and end	Temperature control	Electro-mechanical
Light on when door is open	Yes	Grill type	Gas
Door opening	Drop-down	Soft Close system	Yes

Main oven options

Timer	Yes	Minimum Temperature	120 °F
End-of-cooking alarm	Yes	Maximum temperature	500 °F

Accessories included for main oven and cooktop



Cast iron wok support	1	1.6"-deep tray	1
Oven wire rack	1	Grill mesh	1
TOP Oven grid with back stop	2	Telescopic Guide rails, partial Extraction	1

Electrical Connection

Plug	(B) NEMA 5-15P	Type of electric cable installed	Yes, Single phase
Electrical connection rating	200 W	Power cord length	55 1/8 "
Current	2 A	Frequency	60 Hz
Circuit breaker	15 A	Terminal block	3 pins
Voltage	120 V		

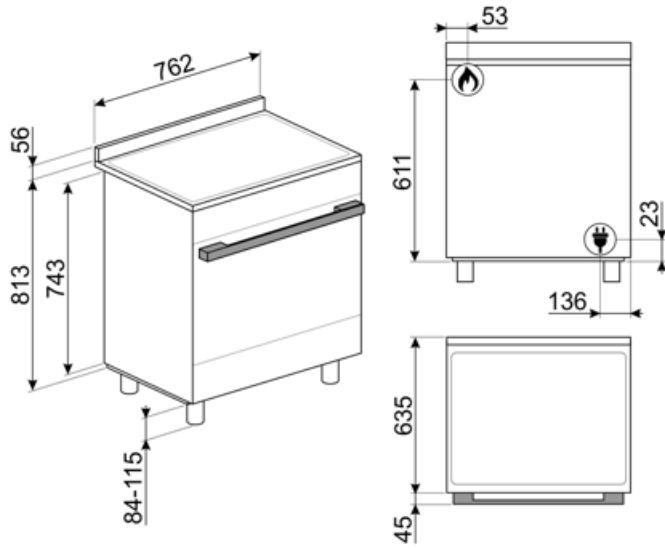

Not included accessories



GT91P

Partial-extraction telescopic guides for 30" Portofino ranges



PALPZ

Pizza shovel with fold away handle
width: 315mm length : 325mm



PRTX



















Refractory pizza stone with handles.
D=35cm Not suitable for microwave ovens. Suitable for gas ovens, to be put on the griddle.



SFLK1

Child lock

Symbols glossary (TT)

 <p>Heavy duty cast iron pan stands: for maximum stability and strength.</p>	 <p>Installation in column: Installation in column</p>
 <p>Air cooling system: to ensure a safe surface temperatures.</p>	 <p>Triple glazed doors: Number of glazed doors.</p>
 <p>Enamel interior: The enamel interior of all Smeg ovens have a special antacid lining which helps keep the interior clean by reducing the amount of cooking grease adhering to it.</p>	 <p>Circogas: In gas ovens the fan distributes the heat quickly and evenly throughout the oven cavity, avoiding flavour transfer when cooking a number of different dishes at the same time. In electric ovens this combination completes cooking more quickly of foods that are ready on the surface, but that require more cooking inside, without further browning.</p>
 <p>Lower heating element only: This function is ideal for foods that require extra base temperature without browning, e.g. pastry dishes, pizza. Also suitable for slow cooking of stews and casseroles.</p>	 <p>Grill element: Using of grill gives excellent results when cooking meat of medium and small portions, especially when combined with a rotisserie (where possible). Also ideal for cooking sausages and bacon.</p>
 <p>Gas ovens offer instantaneous heat control, reduced cooking times and the ability to bake at much lower temperatures than electric ovens.</p>	 <p>All glass inner door: All glass inner door, a single flat surface which is simple to keep clean.</p>
 <p>...</p>	 <p>The inner door glass: can be removed with a few quick movements for cleaning.</p>
 <p>Side lights: Two opposing side lights increase visibility inside the oven.</p>	 <p>Automatic opening: some models have Automatic opening door when the cycle is finished which is a perfect solution for handle-less kitchen units as no handle is needed. For safety reasons, the door locks automatically when the machine is in use to avoid it being opened inadvertently.</p>
 <p>The oven cavity has 4 different cooking levels.</p>	 <p>Soft close: all models are equipped with advanced function of smooth closing of the door, which allows the device to close smoothly and quietly.</p>
 <p>Telescopic rails: allow you to pull out the dish and check it without having to remove it from the oven entirely.</p>	 <p>Ultra rapid burners: Powerful ultra rapid burners offer up to 5kw of power.</p>
 <p>Knobs control</p>	

Benefit (TT)

Gas hob

Induction offers fast cooking and precise temperature control

Equipped with a thermocouple, the gas supply is cut off if the flame is extinguished for greater safety

Touch control

Easy and intuitive timer setting with a single touch

Single turbine

The oven has a fan equipped with a circular heating element allowing cooking with rotating heat

Isothermic Cavity

The best cooking performance at the highest energy efficiency

Tangential cooling

New cooling system with tangential fan and airflow from the door to the splashback

Soft close

The door is equipped with a specific system for silent closing

Multilevel halogen light

Internal halogen lighting on different levels guarantees excellent visibility

Telescopic guides

Easy extraction and safe insertion of trays into the oven thanks to telescopic guides

Adjustable height

Cooker top flushed with the working area thanks to adjustable feet

Removable inner glass

Internal door glasses are easily removable for complete cleaning

Multilevel cooking

Several cooking levels allow maximum flexibility of use

Cold door

During any function, the external door glass is cold, avoiding any risk of burns

AirFry (AIRFRY optional accessory)

Lighter and tastier food thanks to airfry basket

BBQ (optional accessory)

Barbeque cooking directly in the oven with the double-sided grill

Pizza stone (optional accessory)

Baking with refractory stone for soft and crispy pizza and yeast products (STONE optional accessory)

Storage compartment

More space thanks to the lower compartment, ideal for storing accessories or cooking utensils