

# CPF36UGMX

Range size	36"
N. of cavities with energy label	1
Oven energy source	Electricity
Main oven	Thermo-ventilated
Cleaning system - Main oven	VaporClean
EAN code	8017709250683

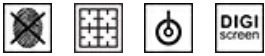

## Aesthetic













<b>Aesthetics</b>	Portofino	<b>Controls color</b>	Stainless steel
<b>Design</b>	Flush mounted	<b>No. of controls</b>	8
<b>Color</b>	Stainless steel	<b>Silkscreen color</b>	Black
<b>Finishing</b>	Satin	<b>Display</b>	Touch
<b>Control panel finish</b>	Fingerprint-proof stainless steel	<b>Door</b>	With frame
<b>Logo</b>	Stainless steel	<b>Door glass type</b>	Gray
<b>Logo position</b>	Fascia below the oven	<b>Handle</b>	Portofino
<b>Upstand</b>	Yes	<b>Handle color</b>	Brushed stainless steel
<b>Cooktop color</b>	Stainless steel	<b>Storage compartment</b>	Push-pull
<b>Grates</b>	Cast Iron	<b>Feet</b>	Stainless steel
<b>Control setting type</b>	Control knobs	<b>Plinth</b>	Black
<b>Control knobs</b>	Portofino		

## Programs / Functions

No. of cooking functions	10
--------------------------	----

### Traditional cooking functions

 Static	 Fan-assisted	 True European convection
 Small grill	 Large grill	 Large grill + Fan
 Bottom	 Convection bottom	 Pizza
 Rotisserie		

### Other functions

 Defrost by time
--











### Cleaning functions

 VaporClean
---

## Cooktop technical features

 <b>UR</b>			
<b>Cooking zones</b> 5			
Left - Gas - Dual ultra-rapid - 5860 W - 20000 BTU			
Rear-center - Gas - AUX - 1310 W - 4500 BTU			
Front-center - Gas - Rapid - 3080 W - 10500 BTU			
Rear-right - Gas - Rapid - 3510 W - 12000 BTU			
Front-right - Gas - Semi-rapid - 2340 W - 8000 BTU			
<b>Burners type</b>	Standard	<b>Gas safety valves</b>	Yes
<b>Automatic gas ignition</b>	Yes	<b>Burner caps</b>	Enameled matte black

## Main Oven Technical Features

									
<b>No. of lights</b>	2	<b>Total no. of door glasses</b>	3						
<b>Fan number</b>	3	<b>No. of thermo-reflective door glasses</b>	2						
<b>Volume</b>	4.45 cu. ft.	<b>Safety thermostat</b>	Yes						
<b>Cavity material</b>	EverClean enamel	<b>Cooling system</b>	Tangential						
<b>No. of shelves</b>	5	<b>Inner cavity dimensions (HxWxD)</b>	370 x 690 x 415 "						
<b>Shelves type</b>	Metal racks	<b>Temperature control</b>	Electro-mechanical						
<b>Light type</b>	Halogen	<b>Bottom heating element - Power</b>	1700 W						
<b>Light Power</b>	40 W	<b>Upper heating element - Power</b>	1200 W						
<b>Time setting</b>	Start and end	<b>Grill power</b>	1700 W						
<b>Light on when door is open</b>	Yes	<b>Large grill - Power</b>	2900 W						
<b>Door opening</b>	Drop-down								
<b>Removable door</b>	Yes								

Full-glass inner door	Yes	Circular heating element	2 x 1550 W
Removable inner door	Yes	- Power	
		Grill type	Electric
		Soft Close system	Yes

## Main oven options

Timer	Yes	Minimum Temperature	120 °F
End-of-cooking alarm	Yes	Maximum temperature	500 °F

## Accessories included for main oven and cooktop



Cast iron wok support	1	1.6"-deep tray	1
TOP Oven grid with back stop	2	Telescopic Guide rails, total Extraction	1

## Electrical Connection

Electrical connection rating	3800 W	Type of electric cable installed	Yes, Double phase
Current	20 A	Power cord length	47 1/4 "
Circuit breaker	20 A	Frequency	60 Hz
Voltage	240/208 V	Terminal block	5 poles

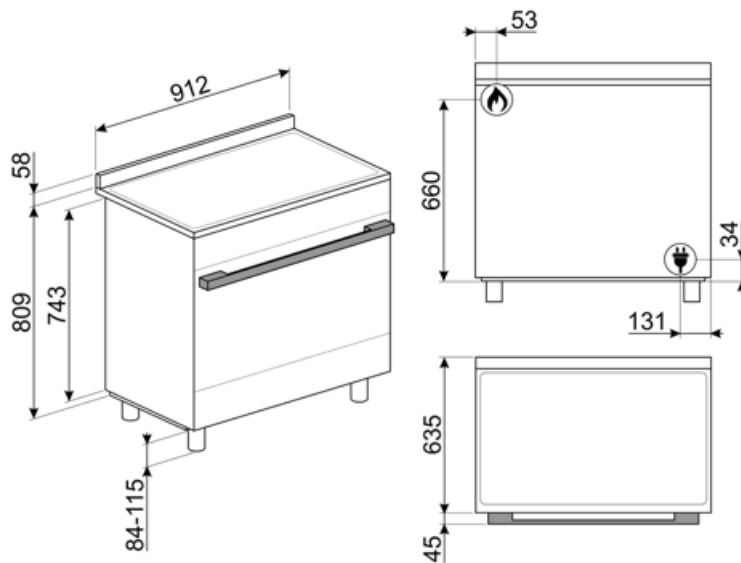

---

## Not included accessories

---



### BGTR9

Cast iron grill plate suitable for 90 cm Victoria, 60 and 90 cm Master and Sinfonia cookers



### PALPZ

Pizza shovel with fold away handle  
width: 315mm length : 325mm



### PRTX

Refractory pizza stone with handles.  
D=35cm Not suitable for microwave ovens. Suitable for gas ovens, to be put on the griddle.



### GT3T



### PPR9

















Refractory pizza stone without handles. Squared stone (HxWxD): 0.9" x 25.2" x 14.75". Also suitable for gas ovens, to be placed on a rack















### SFLK1

Child lock

## Symbols glossary (TT)

 <p><b>Triple Fan Technology:</b> The oven is equipped with an exclusive three fan system, which, combined with the increased power of the motors, enables excellent cooking performance. The two large side fans distribute the air around the outer perimeter of the cavity while the smaller central fan increases ventilation by creating a vertical vortex of heat. Accordingly, the temperature within the cavity is uniform, allowing food to be cooked evenly on all five levels, like in professional kitchens.</p>	 <p><b>Heavy duty cast iron pan stands:</b> for maximum stability and strength.</p>
 <p><b>Installation in column:</b> Installation in column</p>	 <p><b>Air cooling system:</b> to ensure a safe surface temperatures.</p>
 <p><b>Defrost by time:</b> with this function the time of thawing of foods are determined automatically.</p>	 <p><b>Triple glazed doors:</b> Number of glazed doors.</p>
 <p><b>Enamel interior:</b> The enamel interior of all Smeg ovens have a special antacid lining which helps keep the interior clean by reducing the amount of cooking grease adhering to it.</p>	 <p><b>Fingerprint proof stainless steel:</b> Fingerprint proof stainless steel keeps stainless steel looking as good as new.</p>
 <p><b>Circogas:</b> In gas ovens the fan distributes the heat quickly and evenly throughout the oven cavity, avoiding flavour transfer when cooking a number of different dishes at the same time. In electric ovens this combination completes cooking more quickly of foods that are ready on the surface, but that require more cooking inside, without further browning.</p>	 <p><b>Fan with upper and lower elements:</b> The elements combined with the fan aim to provide more uniform heat, a similar method to conventional cooking, so pre-heat is required. Most suitable for items requiring slow cooking methods.</p>
 <p><b>Upper and lower element only:</b> a traditional cooking method best suited for single items located in the centre of the oven. the top pf the oven will always be hottest. Ideal for roast, fruit cakes, bread etc.</p>	 <p><b>Lower heating element only:</b> This function is ideal for foods that require extra base temperature without browning, e.g. pastry dishes, pizza. Also suitable for slow cooking of stews and casseroles.</p>
 <p><b>True European Convection:</b> The combination of the fan and circular heating element around it provides many benefits, including no preheat if cooking time is longer than 20 minutes, no flavor transfer when cooking different foods at the same time, lower energy consumption, and shorter cooking times. Suitable for all types of food preparations.</p>	 <p><b>Grill element:</b> Using of grill gives excellent results when cooking meat of medium and small portions, especially when combined with a rotisserie (where possible). Also ideal for cooking sausages and bacon.</p>
 <p><b>Half grill:</b> For rapid cooking and browning of foods. Best results can be obtained by using the top shelf for small items, the lower shelves for larger ones, such as chops or sausages. For half grill heat is generated only at the centre of the element, so is ideal for smaller quantities.</p>	 <p><b>Fan with grill element:</b> The fan reduces the fierce heat from the grill, providing an excellent method of grilling various foods, chops, steaks, sausages etc. giving even browning and heat distribution, without drying out the food. The top two levels recommended for use, and the lower part of the oven can be used to keep items warm at the same time, an excellent facility when cooking a grilled breakfast. Half grill (centre portion only) is ideal for small quantities of food.</p>

- 
- |  |   |  |   |
|--|---|--|---|
|    | Pizza function: The simultaneous operation of three elements ensures an optimum cooking facility when used with the Smeg pizza stone. |   | Rotisserie: The rotisserie (where installed) works in combination with the grill element to brown foods to perfection.  |
|    | All glass inner door: All glass inner door, a single flat surface which is simple to keep clean.                                      |   | The inner door glass: can be removed with a few quick movements for cleaning.   |
|    | Side lights: Two opposing side lights increase visibility inside the oven.  |   | Automatic opening: some models have Automatic opening door when the cycle is finished which is a perfect solution for handle-less kitchen units as no handle is needed. For safety reasons, the door locks automatically when the machine is in use to avoid it being opened inadvertently. |
|    | The oven cavity has 5 different cooking levels.   |   | Soft close: all models are equipped with advanced function of smooth closing of the door, which allows the device to close smoothly and quietly.  |
|    | Telescopic rails: allow you to pull out the dish and check it without having to remove it from the oven entirely.                     |   | Ultra rapid burners: Powerful ultra rapid burners offer up to 5kw of power.   |
|   | Vapor Clean: a simple cleaning function using steam to loosen deposits in the oven cavity.  |  | ...   |
|  | Knobs control   |  |   |

## Benefit (TT)

---

### **True-convection**

The best cooking performances guaranteed by ventilated circular flow.

Multiple fans and heating elements guarantee the perfect aerodynamic heat flow, allowing homogeneous and quicker cooking inside the cavity.

### **Gas hob**

Induction offers fast cooking and precise temperature control

Equipped with a thermocouple, the gas supply is cut off if the flame is extinguished for greater safety

### **Vapor Clean**

By inserting water into a recess at the bottom of the cavity, steam is generated, which softens the residue and facilitates its removal

By inserting water into a recess at the bottom of the cavity, steam is generated, which softens the residue and facilitates its removal.

### **Touch control**

Easy and intuitive timer setting with a single touch

### **Isothermic Cavity**

The best cooking performance at the highest energy efficiency

### **Triple Turbine**

The oven has three fans and two circular heating elements, allowing cooking with rotating heat

### **Tangential cooling**

New cooling system with tangential fan and airflow from the door to the splashback

### **Soft close**

The door is equipped with a specific system for silent closing

### **Multilevel halogen light**

Internal halogen lighting on different levels guarantees excellent visibility

### **Telescopic guides**

Easy extraction and safe insertion of trays into the oven thanks to telescopic guides

### **Adjustable height**

Cooker top flushed with the working area thanks to adjustable feet

### **Removable inner glass**

Internal door glasses are easily removable for complete cleaning

### **Multilevel cooking**

Several cooking levels allow maximum flexibility of use

### **Cold door**

During any function, the external door glass is cold, avoiding any risk of burns

### **AirFry (AIRFRY optional accessory)**

Lighter and tastier food thanks to airfry basket

### **BBQ (optional accessory)**

Barbeque cooking directly in the oven with the double-sided grill

### **Pizza stone (optional accessory)**

Baking with refractory stone for soft and crispy pizza and yeast products (STONE optional accessory)

### **Push-pull storage compartment**

More space thanks to the lower push-pull compartment, ideal for storing accessories or cooking utensils