

# CPF48UGMOR

Range size	48"
Main oven	Thermo-ventilated
Secondary oven	Static
EAN code	8017709266738



## Aesthetic













<b>Aesthetics</b>	Portofino	<b>Control setting type</b>	Control knobs
<b>Design</b>	Flush mounted	<b>No. of controls</b>	10
<b>Color</b>	Orange	<b>Silkscreen color</b>	Black
<b>Logo</b>	Stainless steel	<b>Display</b>	Touch
<b>Logo position</b>	Fascia below the oven	<b>Handle</b>	Portofino
<b>Cooktop color</b>	Stainless steel	<b>Storage compartment</b>	Storage drawer
<b>Grates</b>	Cast Iron	<b>Plinth</b>	Black

## Programs / Functions

No. of cooking functions 9

### Traditional cooking functions

 Static	 Fan-assisted	 True European convection
 Small grill	 Large grill	 Large grill + Fan
 Bottom	 Convection bottom	 Pizza
 Rotisserie		

### Other functions

 Defrost by time
--

### Cleaning functions



### Secondary oven functions

Convection bottom



### Cooktop technical features

Cooking zones 6

Left - 5300 W - 18000 BTU

Rear-center - 3500 W - 12000 BTU

Front-center - 1310 W - 4500 BTU

Rear-right - 3500 W - 12000 BTU

Front-right - 2340 W - 8000 BTU

Center - 1900 W - 6500 BTU

1.60 (BBQ) W - 5500 (BBQ) BTU

Gas safety valves Yes

Burner caps

Enameled matte black

### Main Oven Technical Features



No. of lights	2
Fan number	3
Volume	0.16 cu. ft.
Cavity material	EverClean enamel
No. of shelves	5
Shelves type	Metal racks
Light type	Halogen
Light Power	40 W
Time setting	Start and end
Light on when door is open	Yes
Removable door	Yes

Total no. of door glasses	3
Safety thermostat	Yes
Cooling system	Tangential
Bottom heating element - Power	1700 W
Upper heating element - Power	1200 W
Grill power	1700 W
Large grill - Power	2900 W
Circular heating element - Power	1500 W
Tilting grill	Yes
Soft Close system	Yes

### Main oven options

Timer	Yes	Minimum Temperature	120 °F
End-of-cooking alarm	Yes	Maximum temperature	500 °F

### Secondary oven - Technical specifications



<b>Fan number</b>	1	<b>Removable door</b>	Yes
<b>Secondary oven - Volume</b>	1.5 cu. ft.	<b>No. total door glasses</b>	3
<b>Cavity material</b>	EverClean enamel	<b>Security Thermostat</b>	Yes
<b>No. of shelves</b>	5	<b>Cooling system</b>	Tangential
<b>Shelves type</b>	Metal racks	<b>Lower heating element - power</b>	750 W
<b>No. of lights</b>	2	<b>Large grill - Power</b>	2050 W
<b>Lighting</b>	Halogen	<b>Circular heating element - Power</b>	1500 W
<b>Light Power</b>	40 W	<b>Grill type</b>	Electric
<b>Light on when oven door is open</b>	Yes	<b>Tilting grill</b>	Yes
<b>Door opening</b>	Drop-down		

## Secondary oven functions

<b>Minimum Temperature</b>	120 °F	<b>Maximum temperature</b>	450 °F
----------------------------	--------	----------------------------	--------

## Accessories included for main oven and cooktop



<b>Cast iron wok support</b>	1	<b>1.6"-deep tray</b>	1
<b>TOP Oven grid with back stop</b>	2	<b>Telescopic Guide rails, total Extraction</b>	1

## Accessories included - Secondary oven



<b>Rack with back and side stop</b>	1	<b>Grill mesh</b>	1
<b>Wide baking tray</b>	1	<b>Telescopic Guide rails, total Extraction</b>	1

## Electrical Connection

<b>Electrical connection rating</b>	8000 W	<b>Power cord length</b>	47 1/4 "
<b>Current</b>	50 A	<b>Frequency</b>	60 Hz
<b>Voltage</b>	240/208 V	<b>Terminal block</b>	5 poles

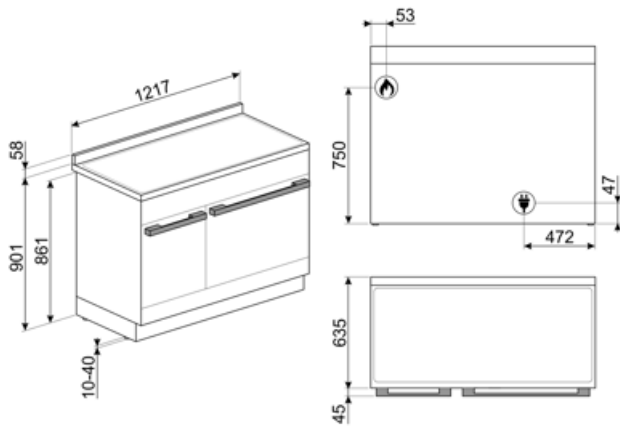

---

## Not included accessories

---

### GTT

**\*\*Total-extension telescopic guides\*\***  
Length: 14" Extraction: 16.5" Material:  
Stainless steel AISI 430 polished



### PPR9

Refractory pizza stone without handles.  
Squared stone (HxWxD): 0.9" x 25.2" x  
14.75". Also suitable for gas ovens, to  
be placed on a rack



### SFLK1

Child lock



### PALPZ

Pizza shovel with fold away handle  
width: 315mm length : 325mm



























### PRTX

Refractory pizza stone with handles.  
D=35cm Not suitable for microwave  
ovens. Suitable for gas ovens, to be  
put on the griddle.



## Symbols glossary (TT)

- |  |  |
|--|--|
|  <p><b>Triple Fan Technology:</b> The oven is equipped with an exclusive three fan system, which, combined with the increased power of the motors, enables excellent cooking performance. The two large side fans distribute the air around the outer perimeter of the cavity while the smaller central fan increases ventilation by creating a vertical vortex of heat. Accordingly, the temperature within the cavity is uniform, allowing food to be cooked evenly on all five levels, like in professional kitchens.</p> |  <p><b>Heavy duty cast iron pan stands:</b> for maximum stability and strength.</p>   |
|  <p><b>Installation in column:</b> Installation in column</p>  |  <p><b>Air cooling system:</b> to ensure a safe surface temperatures.</p>   |
|  <p><b>Defrost by time:</b> with this function the time of thawing of foods are determined automatically.</p>  |  <p><b>Triple glazed doors:</b> Number of glazed doors.</p>   |
|  <p><b>Enamel interior:</b> The enamel interior of all Smeg ovens have a special antacid lining which helps keep the interior clean by reducing the amount of cooking grease adhering to it.</p>   |  <p><b>Circogas:</b> In gas ovens the fan distributes the heat quickly and evenly throughout the oven cavity, avoiding flavour transfer when cooking a number of different dishes at the same time. In electric ovens this combination completes cooking more quickly of foods that are ready on the surface, but that require more cooking inside, without further browning.</p> |
|  <p><b>Fan with upper and lower elements:</b> The elements combined with the fan aim to provide more uniform heat, a similar method to conventional cooking, so pre-heat is required. Most suitable for items requiring slow cooking methods.</p>  |  <p><b>Upper and lower element only:</b> a traditional cooking method best suited for single items located in the centre of the oven. the top pf the oven will always be hottest. Ideal for roast, fruit cakes, bread etc.</p>  |
|  <p><b>Lower heating element only:</b> This function is ideal for foods that require extra base temperature without browning, e.g. pastry dishes, pizza. Also suitable for slow cooking of stews and casseroles.</p>   |  <p><b>True European Convection:</b> The combination of the fan and circular heating element around it provides many benefits, including no preheat if cooking time is longer than 20 minutes, no flavor transfer when cooking different foods at the same time, lower energy consumption, and shorter cooking times. Suitable for all types of food preparations.</p>          |
|  <p><b>Grill element:</b> Using of grill gives excellent results when cooking meat of medium and small portions, especially when combined with a rotisserie (where possible). Also ideal for cooking sausages and bacon.</p>   |  <p><b>Half grill:</b> For rapid cooking and browning of foods. Best results can be obtained by using the top shelf for small items, the lower shelves for larger ones, such as chops or sausages. For half grill heat is generated only at the centre of the element, so is ideal for smaller quantities.</p>  |

- 
-  Fan with grill element: The fan reduces the fierce heat from the grill, providing an excellent method of grilling various foods, chops, steaks, sausages etc. giving even browning and heat distribution, without drying out the food. The top two levels recommended for use, and the lower part of the oven can be used to keep items warm at the same time, an excellent facility when cooking a grilled breakfast. Half grill (centre portion only) is ideal for small quantities of food.
  -  Rotisserie: The rotisserie (where installed) works in combination with the grill element to brown foods to perfection.
  -  The oven cavity has 5 different cooking levels.
  -  Telescopic rails: allow you to pull out the dish and check it without having to remove it from the oven entirely.
  -  Vapor Clean: a simple cleaning function using steam to loosen deposits in the oven cavity.
  -  Knobs control
  -  Pizza function: The simultaneous operation of three elements ensures an optimum cooking facility when used with the Smeg pizza stone.
  -  Side lights: Two opposing side lights increase visibility inside the oven.
  -  Soft close: all models are equipped with advanced function of smooth closing of the door, which allows the device to close smoothly and quietly.
  -  Tilting grill: the tilting grill can be easily unhooked to move the heating element and clean the roof of the appliance in one simple step.
  -  ...

## Benefit (TT)

---

### **True-convection**

The best cooking performances guaranteed by ventilated circular flow.

Multiple fans and heating elements guarantee the perfect aerodynamic heat flow, allowing homogeneous and quicker cooking inside the cavity.

### **Gas hob**

Induction offers fast cooking and precise temperature control

Equipped with a thermocouple, the gas supply is cut off if the flame is extinguished for greater safety

### **Ever Clean Enamel**

Easy oven cleaning thanks to special pyrolytic enamel

### **Touch control**

Easy and intuitive timer setting with a single touch

### **Isothermic Cavity**

The best cooking performance at the highest energy efficiency

### **Triple Turbine**

The oven has three fans and two circular heating elements, allowing cooking with rotating heat

### **Tangential cooling**

New cooling system with tangential fan and airflow from the door to the splashback

### **Soft close**

The door is equipped with a specific system for silent closing

### **Multilevel halogen light**

Internal halogen lighting on different levels guarantees excellent visibility

### **Telescopic guides**

Easy extraction and safe insertion of trays into the oven thanks to telescopic guides

### **Adjustable height**

Cooker top flushed with the working area thanks to adjustable feet

### **Multilevel cooking**

Several cooking levels allow maximum flexibility of use

#### **Cold door**

During any function, the external door glass is cold, avoiding any risk of burns

#### **AirFry (AIRFRY optional accessory)**

Lighter and tastier food thanks to airfry basket

#### **BBQ (optional accessory)**

Barbeque cooking directly in the oven with the double-sided grill

#### **Pizza stone (optional accessory)**

Baking with refractory stone for soft and crispy pizza and yeast products (STONE optional accessory)

#### **Storage compartment**

More space thanks to the lower compartment, ideal for storing accessories or cooking utensils