

CVA 7845

Built-in coffee machine with DirectWater

Perfectly combinable design with CoffeeSelect + AutoDescal for highest demands.



EAN: 4002516419471 / Material number: 11733850 /

Old Material Number: 29784530USA

Brew unit lighting	•
Expert mode	•
MultiLingua	•
MyMiele	•
Help function	•
No. of bean types	3
No. of bean containers	3
Bean container capacity, each in oz (g)	150
Capacity of bean container B in g	150
Capacity of bean container C in g	150
Bean container capacity, total in oz (g)	21.16 (600)
Removable bean container	•
Capacity of water container in fl oz (l)	91.3 (2.7)
Milk container capacity in l	0.7
Capacity of waste container in servings	17
Drip tray capacity in fl oz (l)	54.1 (1.6)
Easily accessible containers	•
Time-of-day display	•
Time synchronization	•
Date display	•
Programmable switch-on time	•
Programmable switch-off time	•
Programmable stand-by time	•
Individual settings	•
Drink specialties	
Adjustable beverage portion size in ml	20-300
Ristretto, single	•
Ristretto, double	•
Espresso, single	•
Espresso, double	•
Coffee, single	•
Coffee, double	•
Long coffee, single	•
Long coffee, double	•
Cappuccino, single	•
Cappuccino, double	•
Latte macchiato, single	•
Latte macchiato, double	•
Hot milk, single	•
Latte macchiato, double	•
Milk froth, single	•
Milk froth, double	•
Espresso macchiato, single	•
Espresso macchiato, double	•
Cappuccino italiano, single	•
Cappuccino italiano, double	•
Flat white, single	•
Flat white, double	•

CVA 7845

Built-in coffee machine with DirectWater

Perfectly combinable design with CoffeeSelect + AutoDescal for highest demands.

EAN: 4002516419471 / Material number: 11733850 /

Old Material Number: 29784530USA

Café au lait, single	•
Café au lait, double	•
Caffè latte, single	•
Caffè latte, double	•
Caffè americano, single	•
Caffè Americano, double	•
Long black, single	•
Long black, double	•
Allwater	•
Warm water, double	•
Hot water, single	•
Hot water, double	•
Black tea, single	•
Black tea, double	•
Herbal tea, single	•
Herbal tea, double	•
Fruit tea, single	•
Fruit tea, double	•
Green tea, single	•
Green tea, double	•
White tea, single	•
White tea, double	•
Japanese tea, single	•
Japanese tea, double	•
Chai latte, single	•
Chai latte, double	•
Coffee pot	•
Teapot	•
Efficiency and sustainability	
Energy-saving Eco mode option	•
Power rating in standby mode in W	0.3
Power rating in networked standby in W	2.0
Time until automatic switch to off mode in min	20
Time until automatic switch to standby in min	20
Time until automatic switch to networked standby in min	20
Cleaning convenience	
AutoDescal	•
Manual descaling	•
AutoClean	•
Automatic rinsing of the milk pipework from the water container	•
Convenient cleaning programs	•
Auto-Off function	•
ComfortClean	•
Removable milk pipework	•
Removable brew unit	•
Adjustable water hardness	•
Safety	
System lock	•

CVA 7845

Built-in coffee machine with DirectWater

Perfectly combinable design with CoffeeSelect + AutoDescal for highest demands.



EAN: 4002516419471 / Material number: 11733850 /

Old Material Number: 29784530USA

Technical data	
Niche width min in in.(mm)	22 1/8 (560)
Niche width max in in.(mm)	22 3/8 (568)
Niche height min in in.(mm)	17 3/4 (450)
Niche height max in in.(mm)	17 7/8 (452)
Niche depth in in.(mm)	21 3/4 (550)
Height-adjustable serving spout in inches (cm)	6 1/2 (16.5)
Height-adjustable serving spout in inches (cm)	1 5/8 (4.0)
Appliance width in in.(mm)	23 1/2 (595)
Appliance height in in.(mm)	18 (455)
Appliance depth in in.(mm)	18 7/8 (478)
Depth with door open in in.(cm)	42 5/8 (108.0)
Total connected load in kW	1.45
Voltage in V	120
Fuse rating in A	15
Number of phases	1
Length of electrical wire in ft (m)	6 (2.0)
Standard accessories	
Glass milk container	•
Descaling cartridge	•
AutoCleaner	•

CVA 7845

Built-in coffee machine with DirectWater

Perfectly combinable design with CoffeeSelect + AutoDescal for highest demands.

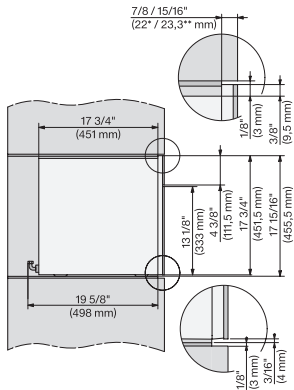

CVA7445, CVA7845, installation drawing, side view, Flush inset

7/8" – 22* mm – Glass, 15/16" – 23.3** mm – Stainless steel

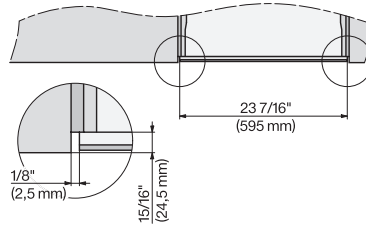

CVA7440, CVA7445, CVA7840, CVA7845, installation drawing, view from above, 60 cm, Flush inset

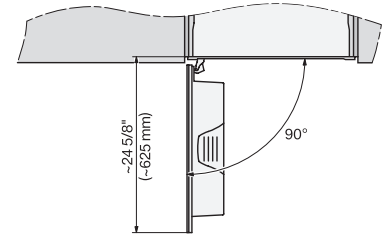

CVA7440, CVA7445, CVA7840, CVA7845, installation drawing, view from above, 60 cm, Flush inset

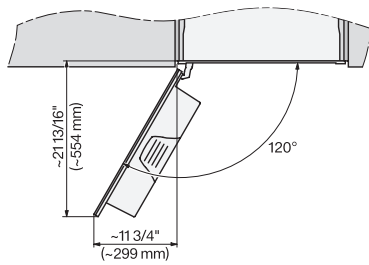

CVA7440, CVA7445, CVA7840, CVA7845, installation drawing, view from above, 60 cm, Flush inset

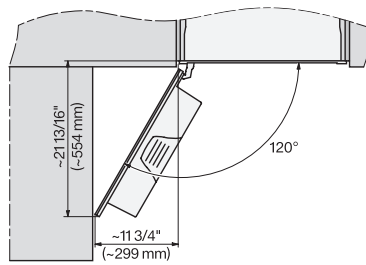

CVA7440, CVA7445, CVA7840, CVA7845, installation drawing, view from above, 60 cm, Flush inset

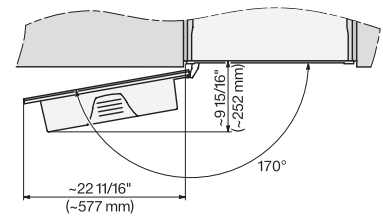

CVA7440, CVA7445, CVA7840, CVA7845, installation drawing, view from above, 60 cm, Flush inset

CVA 7845

Built-in coffee machine with DirectWater

Perfectly combinable design with CoffeeSelect + AutoDescal for highest demands.

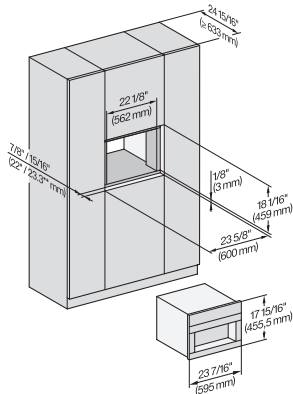

CVA7440, CVA7745, CVA7840, CVA7845, installation drawing, built in, 60 cm, Flush inset

7/8" – 22* mm – Glass, 15/16" – 23.3** mm – Stainless steel

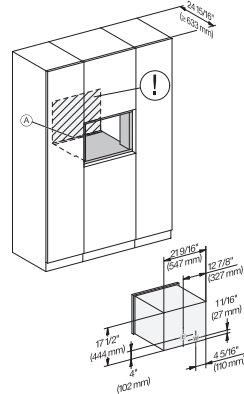

CVA7445, CVA7845, installation drawing, 60 cm, Flush inset

A – Cut-out (1 1/2" x 20" / 38 mm x 508 mm) in the bottom of the cabinet for power cord and ventilation, – Electrical and water supplies are recommended to be placed in adjacent cabinetry. Additional cabinet depth is required when placing the electrical and water supplies behind the appliance., E = Electric connection, W = Water connection

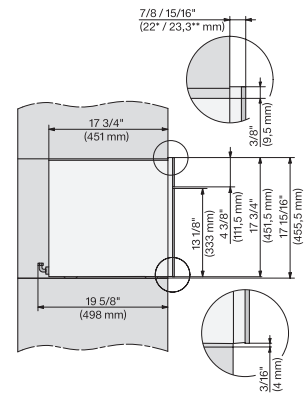

CVA7445, CVA7845, side view, 60 cm, Proud

7/8" – 22* mm – Glass, 15/16" – 23.3** mm – Stainless steel

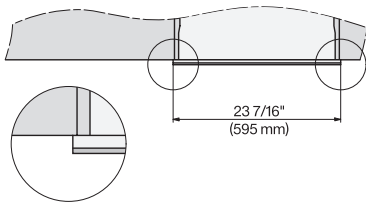

CVA7440, CVA7445, CVA7840, CVA7845, installation drawing, view from above, 60 cm, Proud

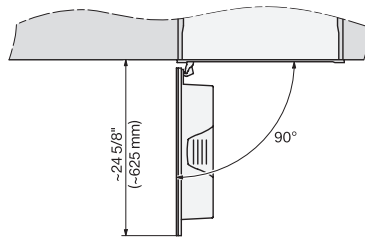

CVA7440, CVA7445, CVA7840, CVA7845, installation drawing, view from above, 60 cm, Proud

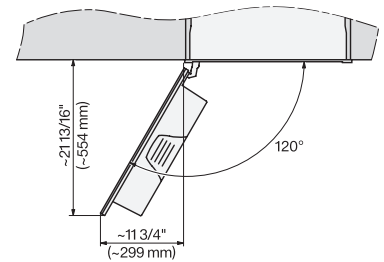

CVA7440, CVA7445, CVA7840, CVA7845, installation drawing, view from above, 60 cm, Proud

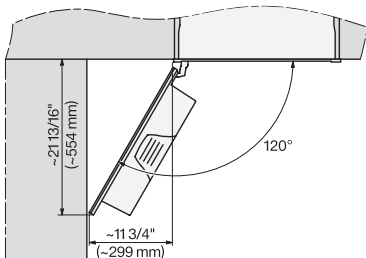

CVA7440, CVA7445, CVA7840, CVA7845, installation drawing, view from above, 60 cm, Proud

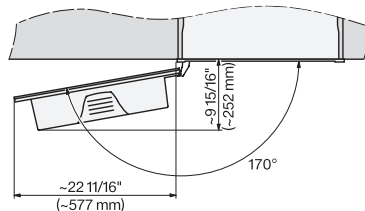

CVA7440, CVA7445, CVA7840, CVA7845, installation drawing, view from above, 60 cm, Proud

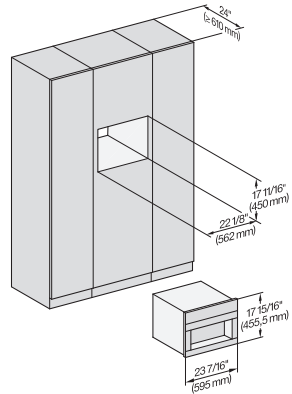

CVA7440, CVA7445, CVA7840, CVA7845, installation drawing, built in, Einbau, 60 cm, Proud

CVA 7845

Built-in coffee machine with DirectWater

Perfectly combinable design with CoffeeSelect + AutoDescal for highest demands.

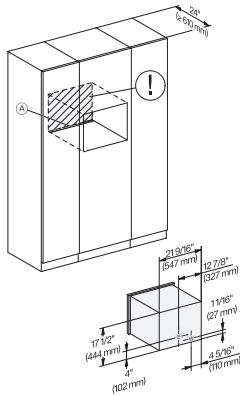

CVA7445, CVA7845, installation drawing, installation,
60 cm, Proud

A – Cut-out (1 1/2" x 20" / 38 mm x 508 mm) in the bottom of the cabinet for power cord and ventilation, – Electrical and water supplies are recommended to be placed in adjacent cabinetry., Additional cabinet depth is required when placing the electrical and water supplies behind the appliance., E = Electric connection, W = Water connection