

CVIU338RX1



Installation	Built-in
Built-In Niche	82-87 cm
Defrost	Automatic
Cooling type	Fan-assisted
Hinge type	Standard
Hinge position	Right-hand



Wine compartment features



Number of fixed shelves	2
Number of removable shelves	3
Shelves material	Wood
Removable shelves on telescopic guide rails	Yes
Type of internal light	LED
Air filter	Activated charcoal filter

Functions



Control setting	Touch controls	Child lock	Yes
Controls	Inside the cooler	Forced light on	Time-limited
Display type	LED	Continuous fan mode	Yes
Display functions	Temperature Alarm, Temperature indication	Temperature Alarm	Yes
Power-on indicator	Yes	Door open alarm	Yes

Technical Features

Adjustable temperature zones	2	Compressor type	Reduced vibration
Independent cooling systems	2	Refrigerant gas type	R600a
Number of door glasses	2	Refrigerant quantity	0.7 oz
		Foam agent	HFO
		Metal back panel	Metal

Temperature range	41°-68°F	Adjustable feet	2 Front + 2 Rear
Temperature setting type	Electronic	Door opening type	With handle
Anti-UV door glass	Yes		
Integrated heating element	Yes		
Number of compressors	1		

Performance / Energy Label

Max Capacity (bottles 0,75lt)	38	Sum of the volumes of the frozen compartment(s)	0.0 gal
Annual energy consumption	130 kWh/year	Refrigerator volume	30.6 gal
Airborne acoustical noise emission class	C	Climatic class	SN, N, ST
Total net volume	30.6 gal	EI	153 %

Electrical Connection

Electrical connection rating	40 W	Frequency (Hz)	50/60 Hz
Current	0,4 A	Power cord length	70 7/8 "
Voltage (V)	115 V	Plug	(B) NEMA 5-15P

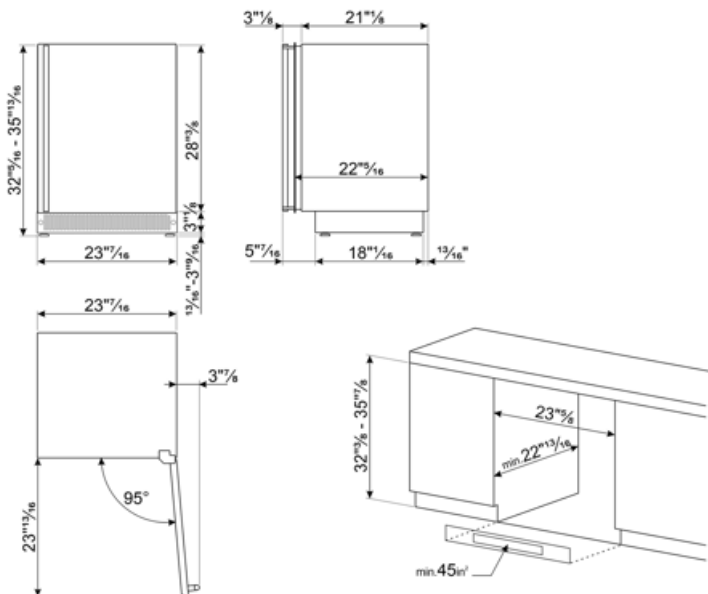







Alternative products



CVIU138RG1

Color: Neptune Grey

Symbols glossary

- | | | | |
|--|--|---|--|
|  | The automatic defrost system works by automatically defrosting at regular intervals eliminating the need to defrost altogether. |  | LED display: to show programmes, functions and options selected and the time to the end of the cycle. |
|  | Ventilated: Forced distribution of cold air in the refrigerator compartment, which allows even temperature distribution within the fridge. |  | Fingerprint proof stainless steel: Fingerprint proof stainless steel keeps stainless steel looking as good as new. |
|  | LED interior lighting: is a more energy efficient and long lasting way of illuminating the interior of the appliance. |  | Built-in niche |
|  | Touch controls: Easy to use touch controls allow the appliance to be programmed at the touch of a button. | | |