

DW8610



| | |
|-------------------|------------------|
| Product family | Dishwashers |
| Commercial height | 86 cm |
| Installation | Fully-Integrated |
| N° baskets | 3, Flexi |
| Engine | Inverter |
| EAN code | 8017709354794 |



Programs



| | | | |
|----------------------|-----------------------|-------------|-----|
| Number of programs | 10 | Normal | Yes |
| Washing temperatures | 30, 40, 50, 65, 75 °F | Rinse | Yes |
| Automatic | Yes | Eco express | Yes |
| Intense | Yes | Express 60' | Yes |
| Self Clean | Yes | Pots & Pans | Yes |
| Delicates | Yes | | |

Options



| | | | |
|----------------------------|----------------|-------------------------------|-----|
| Dry Assist+ option | Yes | Intensive washing zone option | Yes |
| Delay start | Up to 24 hours | Special programs option | Yes |
| FlexiZone half-load option | Yes | | |

Baskets



| | | | |
|---------------------------------------|---------------------|-------------------------------------|-------------|
| Basket color | Gray | Lower basket | Fixed racks |
| Upper basket | Central fixed racks | Lower basket with anti-drip inserts | Yes |
| Upper basket height adjustment | On 3 levels | Colour Inner Components | Sage Leaf |
| Largest loadable dish in upper basket | 19,0 inches | Cutlery basket | Yes |

Technical Features



| | | | |
|-------------------------------|---|--|---|
| Width | 23 9/16 " | Flood protection system | Single Aquastop |
| Depth | 21 5/8 " | Max water hardness | 100°FH;58°dH |
| Display type | LED display (3 digits) | Drying system | Natural condenser drying, with Dry Assist + automatic door opening system at the end of the cycle |
| Height | 33 3/4 " | Tub material | Stainless steel |
| Display | Delay start, Program progress indicator | Filter | Stainless steel |
| Program symbols | Writings in English | Hinges | Self-balancing, Sliding, FLEXIFIT |
| On/off indicator | Yes | Min. and max. frontal panel weight | 4.4 - 24.3 lbs |
| Rinse aid indicator | Light | Min. and max plinth height | 50 - 215 mm |
| End-of-cycle indicator | Acoustic signal | Adjustable feet | 2 3/4", from 33 7/8" to 36 5/8" |
| Auto switch-off | Yes | Additional gaskets | Yes |
| Washing system | Orbital | Back cover | Yes |
| Third spray arm | Single | Depth of dishwasher with open door (mm) | 1186 mm |
| Turbidity sensor | Yes | Top cover | Metal sheet |
| Aquatest | | | |

Electrical Connection

| | | | |
|------------------------|--------|----------------------------------|----------------|
| Connected power | 1100 W | Connection type | Single-phase |
| Current | 13 A | Power supply cable length | 140 " |
| Voltage | 115 V | Plug | (B) NEMA 5-15P |
| Frequency (Hz) | 60 Hz | | |

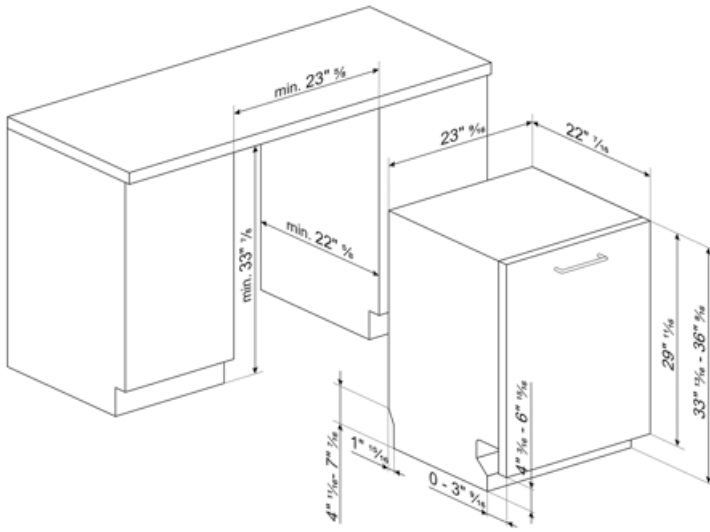

Compatible Accessories



KIT86PORTRD



KIT86SPRAN



KIT86SPRMW



KIT86SPRX

KITFLEXI



KITJBDW



KITPL60B

Toekick Kit in White colour with adjustable height and deepness. Can be installed over all the fully integrated and underbench models with variable fulcrum or flexifit hinges.

KITPL60N

Toekick Kit in Black colour with adjustable height and deepness. Can be installed over all the fully integrated and underbench models with variable fulcrum or flexifit hinges.



KITPL60X





















Toekick Kit in Stainless Steel with adjustable height and deepness. Can be fitted over all the fully integrated and underbench models with variable fulcrum or flexifit hinges.

KITPLV2

Kit extension for dishwasher and washing machine: lenght mt. 2



Symbols glossary

| | |
|--|--|
|  <p>Acquastop: Some Smeg dishwashers are equipped with a simple Acquastop: float sensor in the bottom which is necessary to prevent an accidental leakage of water inside the appliance.</p> |  <p>Aquatest measures the clarity of the water during an auto program, and automatically ensures the minimum consumption of water and energy.</p> |
|  <p>Anti-drip: Some models of dishwashers are equipped with special polymer nozzles anti-drip, that improve the process of drying.</p> |  <p>COMM_HEIGHT_86_72dpi</p> |
|  <p>Delay Timer: The delay timer can postpone the start of the program by up to 24 hours.</p> |  <p>Models with new Flexi Fit hinges are able to be installed in kitchens with a plinth of just 5cms. With this new hinge design, the panel has a sliding movement from the bottom to the top, avoiding any possible interference of the panel with the plinth.</p> |
|  <p>FlexiZone: The ½ load flexizone allows you to wash a reduced load saving energy, water and time and there are no restrictions on where the items are placed.</p> |  <p>Inverter technology: The evolution of Smeg's driers towards more intelligent and environmentally sustainable models has led to the choice of using Inverter technology with heat pumps, which reduces significantly energy consumption.</p> |
|  <p>Noise Level: Excellent insulation and special devices keep noise to a minimum.</p> |  <p>Orbital wash system distributes water evenly throughout the 60cm dishwasher cavity, directing water with precision to ensure an excellent wash.</p> |
|  <p>Auto 45°- 65°: The auto programme regulates the length of a cycle depending on the need for a pre-wash and the number of rinses required.</p> |  <p>Delicate: Delicate washing program is designed for delicate dishes which are not heavily soiled.</p> |
|  <p>PRG_RINSE_72dpi</p> |  <p>Ultraclean: The Ultraclean option performs a final rinse at a high temperature of 70°C eliminating virtually all bacteria.</p> |
|  <p>The symbols show the number of plate settings of the dishwasher.</p> |  <p>System WaterSave ensures the best washing results with minimal water consumption depending on the model of dishwasher.</p> |
|  <p>Dishwasher cleaning cycle. The cycle should be started with the machine empty, without dishes. It is recommended to run the program every 2-3 months, using special dishwasher detergents.</p> |  <p>SILENT: Wash cycle suitable for normally soiled dishes, even with dried-on residues. Ensures maximum noise reduction and is therefore ideal if you wish to run it during the night.</p> |
|  <p>Allows you to enable additional programs when selected together with any wash cycle.</p> |  <p>The Dry Assist + option, in addition to saving energy, ensures perfect drying of the dishes by opening the door automatically at the end of the wash cycle.</p> |