

DW8630

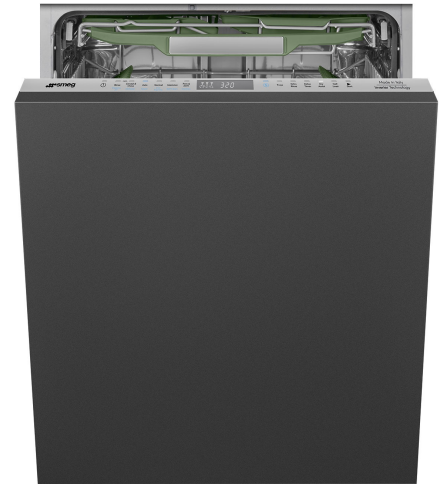

Product family	Dishwashers
Commercial height	86 cm
Installation	Fully-Integrated
N° baskets	3, FlexiDuo
Engine	Inverter
EAN code	8017709355258



Programs



Number of programs	12+2	Auto	Yes
Washing temperatures	38, 45, 50, 55, 65, 70, 75 °F	Rinse	Yes
Express 27'	Yes	Crystal & China	Yes
Mix	Yes	Eco express	Yes
Self Clean	Yes	Pots & Pans	Yes
Sterilize	Yes	Trays	Yes
Delicates	Yes		

Options



Dry Assist option	Yes	Intensive washing zone option	
Delay start	Up to 24 hours	Special programs option	Yes
FlexiZone half-load option	Yes	Clean&Shine option	Yes

Baskets



Basket color	Gray	Lower basket accessories	MultiLoad, ProFlex Holder, WinePro
Upper basket	3 foldable racks	Lower basket with anti-drip inserts	Yes
Upper basket height adjustment	On 3 levels	Largest loadable dish in lower basket	35,0 inches

Sliding Guides Extra Glide	Yes
Largest loadable dish in upper basket	19,0 inches
Lower basket	With 4 foldable racks

Colour Inner Components	Sage Leaf
Cutlery basket	Yes

Technical Features

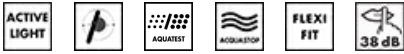

Width	23 9/16 "
Depth	21 5/8 "
Display type	LED display (3 digits)
Height	33 3/4 "
Display	Delay start, Program progress indicator, Time-to-end indicator, Consumptions
Program symbols	Writings in English
Salt indicator	Light
Rinse aid indicator	Light
End-of-cycle indicator	ActiveLight
Auto switch-off	Yes
Washing system	Planetarium
Third spray arm	Single
Water softener	With electronic setting
Turbidity sensor	Yes
Aquatest	
Flood protection system	Total Aquastop

Max water hardness	100°FH;58°dH
Drying system	Natural condenser drying, with Dry Assist automatic door opening system at the end of the cycle
Internal lighting	White LED
Tube material	Stainless steel
Filter	Stainless steel
Concealed heating element	Yes
Hinges	Self-balancing, Sliding, FLEXIFIT
Min. and max. frontal panel weight	4.4 - 22 lbs
Min. and max plinth height	50 - 215 mm
Adjustable feet	2 3/4", from 33 7/8" to 36 5/8"
Airborne acoustical noise emissions dBA	38 dBA
Additional gaskets	Yes
Back cover	Yes
Depth of dishwasher with open door (mm)	1186 mm
Top cover	Metal sheet

Electrical Connection

Connected power	1100 W	Connection type	Single-phase
Current	13 A	Power supply cable length	140 "
Voltage	115 V	Plug	(B) NEMA 5-15P
Frequency (Hz)	60 Hz		

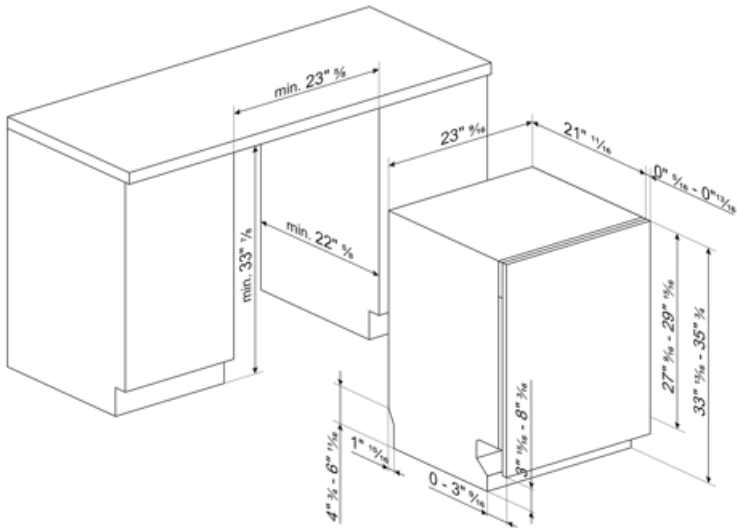

Compatible Accessories



KIT86PORTAN-1



KIT86SPRAN



KIT86SPRMW



KIT86SPRX

KITFLEXI



KITJBDW



KITPL60B

Toekick Kit in White colour with adjustable height and deepness. Can be installed over all the fully integrated and underbench models with variable fulcrum or flexifit hinges.



KITPL60N

Toekick Kit in Black colour with adjustable height and deepness. Can be installed over all the fully integrated and underbench models with variable fulcrum or flexifit hinges.



KITPL60X

Toekick Kit in Stainless Steel with adjustable height and deepness. Can be fitted over all the fully integrated and underbench models with variable fulcrum or flexifit hinges.

























KITPLV2

Kit extension for dishwasher and washing machine: lenght mt. 2



Symbols glossary

	<p>Activelight is an led light which projects a red spot onto the floor beneath the dishwasher when the appliance is in use.</p>		<p>Aquatest measures the clarity of the water during an auto program, and automatically ensures the minimum consumption of water and energy.</p>
	<p>Anti-drip: Some models of dishwashers are equipped with special polymer nozzles anti-drip, that improve the process of drying.</p>		<p>Clean&Shine option: For perfect cleaning results, this option adds an extra rinse to the wash cycle, which also gives the dishes a higher gloss.</p>
	<p>COMM_HEIGHT_86_72dpi</p>		<p>Delay Timer: The delay timer can postpone the start of the program by up to 24 hours.</p>
	<p>Enersave: At the end of the drying cycle a special device slowly automatically opens the door a few centimeters, to ensure perfect drying and to save up to 20% of energy on some models.</p>		<p>FlexiDuo: The FlexiDuo 3rd cutlery basket allows you to arrange cutlery or small cups, ladles, or bulky utensils however you like: it consists of two separate and moveable modules.</p>
	<p>Models with new Flexi Fit hinges are able to be installed in kitchens with a plinth of just 5cms. With this new hinge design, the panel has a sliding movement from the bottom to the top, avoiding any possible interference of the panel with the plinth.</p>		<p>FlexiZone: The ½ load flexizone allows you to wash a reduced load saving energy, water and time and there are no restrictions on where the items are placed.</p>
	<p>The new ExtraGlide guide system, available on top of the range models, makes the second basket even smoother and softer. In fact, it facilitates the extraction of the introduction, even at full load and, for the greater excursion, the insertion of crockery is also facilitated in the rear part.</p>		<p>Inverter technology: The evolution of Smeg's driers towards more intelligent and environmentally sustainable models has led to the choice of using Inverter technology with heat pumps, which reduces significantly energy consumption.</p>
	<p>Noise Level: Excellent insulation and special devices keep noise to a minimum.</p>		<p>PLANETARIUM_WASHING_SYSTEM_72dpi</p>
	<p>Delicate: Delicate washing program is designed for delicate dishes which are not heavily soiled.</p>		<p>Delicate: Delicate washing program is designed for delicate dishes which are not heavily soiled.</p>
	<p>PRG_RINSE_72dpi</p>		<p>Rapid 27 Mins: The rapid 27 mins quick program takes just 27 minutes to wash a load.</p>
	<p>Total Acquastop: In addition to the partial Acquastop protection present in all Smeg dishwashers, some models have an electronic device fitted to the water intake hose, which monitors water levels in the machine, detects leaks in the hose and switches off the water supply immediately when necessary.</p>		<p>System WaterSave ensures the best washing results with minimal water consumption depending on the model of dishwasher.</p>
	<p>Dishwasher cleaning cycle. The cycle should be started with the machine empty, without dishes. It is recommended to run the program every 2-3 months, using special dishwasher detergents.</p>		<p>SILENT: Wash cycle suitable for normally soiled dishes, even with dried-on residues. Ensures maximum noise reduction and is therefore ideal if you wish to run it during the night.</p>



Allows you to enable additional programs when selected together with any wash cycle.



STERYL 75°: Intensive wash cycle ideal for plates, pots, pans, cutting boards, feeding bottles.



Baking tray programme: for intensive cleaning of the oven trays. Place the trays in the lower basket of the dishwasher.