

EC3050TE/S**FEATURES**

Full-color touchscreen simplifies use and adds refinement to the design

Save favorites within six independent user profiles for a perfect cup that's just a touch or two away

Easily customize every aspect of your beverage, including type, strength, temperature, quantity, and milk preference

Beverage options include Americano, Cappuccino, Coffee, Doppio, Espresso, Flat White, Hot Milk, Hot Water, Latte, Latte Macchiato, Long Coffee, Macchiato, Milk Froth, Steam

Insulated milk container with light-to-thick froth regulator

Accepts whole bean or ground coffee

The large 84.5-ounce water tank yields 6 cups of 9 oz coffee before needing to be refilled

Dual-dispensing spout easily adjusts to the height of your cup

Self-cleaning system ensures your perfect cup is only moments away—no cumbersome cleanup

Discreet in-unit storage

Installs nearly anywhere—without special water lines

The elegant, modern aesthetic perfectly pairs with a full suite of similarly styled Sub-Zero, Wolf, and Cove appliances

Built with premium-grade materials, Wolf products are designed to last a minimum of 20 years

ACCESSORIES

Care Kit

Charcoal Filter

Coffee Pot

Descaling Solution

Insulated Milk Container

Accessories available through an authorized dealer.

For local dealer information, visit subzero-wolf.com/locator.



PRODUCT SPECIFICATIONS

Model	EC3050TE/S
Dimensions	29 7/8"W x 17 7/8"H x 19"D
Weight	76 lbs
Electrical Supply	120 VAC, 60 Hz
Electrical Service	15 amp dedicated circuit
Power Cord Length	6 Feet
Receptacle	3-prong grounding-type

ELECTRICAL

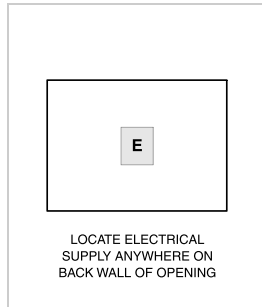

NOTE: Dimensions in parenthesis are in millimeters unless otherwise specified

DIMENSIONS

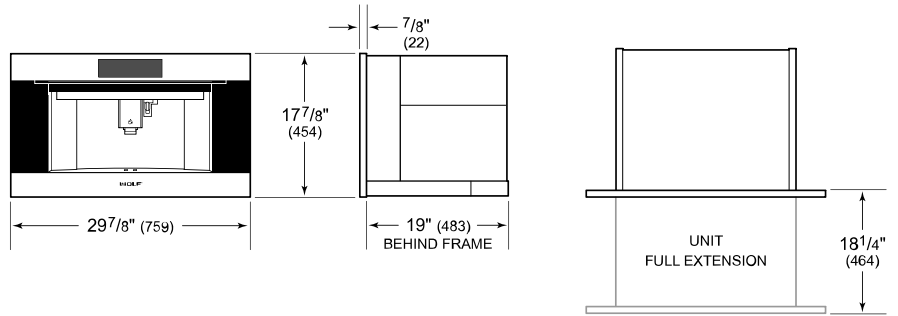

FLUSH INSTALLATION

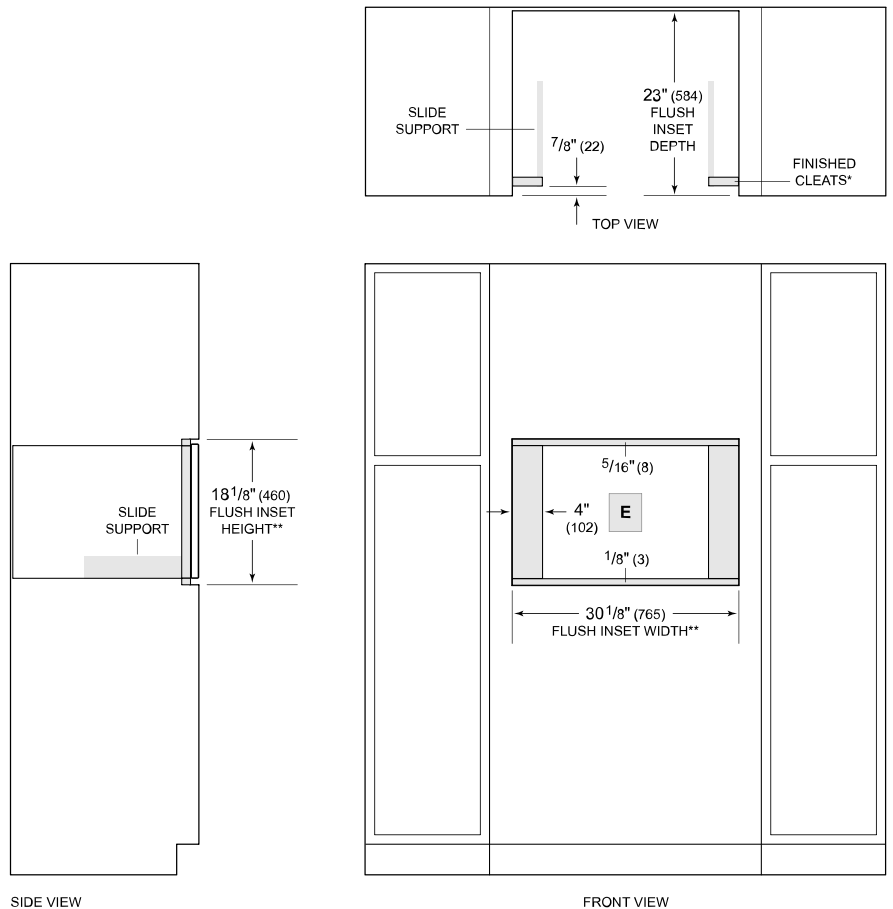

*Will be visible and should be finished to match cabinetry.
 **Dimension provides minimum reveals.