

# FD30UXI



<b>Product family</b>	Refrigerator
<b>Installation</b>	Freestanding
<b>Category</b>	French-door
<b>No-frost system</b>	Yes
<b>Cooling type</b>	Total no-frost - Dual-flow cooling system
<b>Defrost</b>	Automatic
<b>Hinge</b>	Standard
<b>Counter-depth</b>	Yes
<b>EAN code</b>	8017709344023



## Aesthetic



<b>Aesthetics</b>	SPR	<b>Side material</b>	Steel
<b>Color</b>	Stainless steel	<b>Side color</b>	Steel
<b>Material</b>	Steel	<b>Logo</b>	Applied
<b>Door stainless steel type</b>	Normal	<b>Door shelf profile color</b>	Silver
<b>Handle</b>	External	<b>Drawers profile color</b>	Silver
<b>Handle</b>	Fixed	<b>Glass shelf profile color</b>	Silver
<b>Handle color</b>	Stainless steel	<b>Display</b>	LED
<b>Logo color</b>	Stainless steel	<b>Display position</b>	Internal

## Refrigerator compartment features



<b>Number of compartments</b>	3	<b>Type of crisper cover</b>	Glass
<b>Compartment types</b>	Low temperature compartment, Fruit and vegetable compartment	<b>No. of lights</b>	1
<b>Type of adjustable shelves</b>	Glass	<b>Low temperature compartment</b>	Yes
<b>Crisper drawer type</b>	Standard	<b>Refrigerator lighting</b>	Yes
<b>Crisper cover</b>	Yes	<b>Refrigerator lighting</b>	LED

## Refrigerator Inner Door

Number of adjustable door shelves	4	No. of bottle shelves	2
-----------------------------------	---	-----------------------	---

## Other Refrigerator features



Humidity Control	Yes	Fan	Yes
MultiFlow	Yes		

## Freezer features

Number of drawers	2	Freezer lighting	Yes
No. of lights	2	Freezer lighting	LED

## Other Freezer features

Accessories	1 x ice box	Ice maker	Automatic
-------------	-------------	-----------	-----------

## Other technical features



Display functions	Holiday, Fast-freezing, Sabbath
Fast-freezing button	Yes
Water network connection	Yes
Power-on light	Yes
Temperature alarm	Yes
Door open alarm	Yes
Temperature setting type	Electronic
No. of compressors	1
Refrigerant gas type	R600a
Compressor type	Inverter
No. of evaporators	2
Foam agent	Cyclopentane

## Performance / Energy Label

Total volume	16.10 cu. ft.	Noise level	39 dB(A) re 1 pW
Freezer volume	5.19 cu. ft.	Freezer capacity	5.76 cu. ft.
Refrigerator compartment	10.81 cu. ft.	Refrigerator volume	11.72 cu. ft.

## Electrical Connection

Electrical connection rating	200 W	Frequency (Hz)	60 Hz
------------------------------	-------	----------------	-------







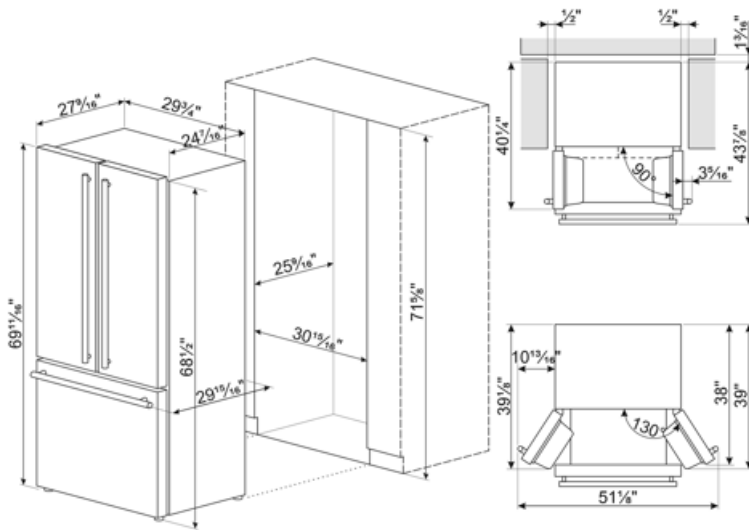

Current	2 A	Power cord length	84 5/8 "
Voltage (V)	120 V	Plug	(B) NEMA 5-15P

## Logistic Information

Width	29 15/16 "	Width with doors open at 90°	50 7/8 "
Depth without handle	27 9/16 "	Product depth (handle included)	29 15/16 "
Height	69 11/16 "	Depth with door open at 90°	40 1/4 "



## Symbols glossary

- |  |   |   |   |
|--|---|---|---|
|  | The automatic defrost system works by automatically defrosting at regular intervals eliminating the need to defrost altogether.   |  | LED display: to show programmes, functions and options selected and the time to the end of the cycle.                               |
|  | Ventilated: Forced distribution of cold air in the refrigerator compartment, which allows even temperature distribution within the fridge.  |  | Fast freezing: The fast freezing function brings the temperature of the compartment down when activated a few hours prior to usage. |
|  | Power saving mode: The power saving mode allows you to disable the refrigerator and keep the freezer working.   |  | LED interior lighting: is a more energy efficient and long lasting way of illuminating the interior of the appliance.               |
|  | Inverter technology: The evolution of Smeg's driers towards more intelligent and environmentally sustainable models has led to the choice of using Inverter technology with heat pumps, which reduces significantly energy consumption. |  | Air plus: keeps food fresher for longer.  |
|  | Sabbath: This function allows you to cook food during the Sabbath, the Holiday of rest in the Jewish religion, respecting the precepts.   |   |   |