

Version FNPLS36W5SS-R / Wall 36" (90 cm) - 500 CFM
Collection Silence - NRS

FEATURES AND PROPERTIES

Materials/Finishes Scotch brite stainless steel (AISI 304)

Technology NRS technology for a quieter kitchen
 SRS Speed reduction system

Control Electronic control

Ducting type Extracting/Filtering

Installation type Wall

Lighting LED 3x1,2 W - 3200 K

Filters Air Falmec filter for balanced suction
 Combined Carbon.Zeo filter, regenerable

Ducting type

Dimensions 36 in

Minimum Electric hob distance 21 in

Minimum Gas hob distance 25 in

Notes Recommended mounting height from cooking surface to hood bottom: 24" - 35"

Availability Carbon.Zeo filter KACL.1039 for hoods produced from Sept. 2024



Photograph is for information purposes only. May not correspond to the selected version

ELECTRICAL CONNECTION AND CONSUMPTION

Maximum consumption 280 W

Voltage/Frequency 110-120V 60Hz

Connection type Hood comes standard with Nema 5-15P power cord

BLOWER PERFORMANCE

Motor 500 CFM

Minimum sound level 37 dB (A)re1pW I.E.C. 60704-2-13

Maximum sound level 46 dB (A)re1pW I.E.C. 60704-2-13

WEIGHTS AND DIMENSIONS

Gross weight 89 lbs

Net weight 75 lbs

Volume 19 ft

Packaging dimensions L 41 x H 27 x D30 in

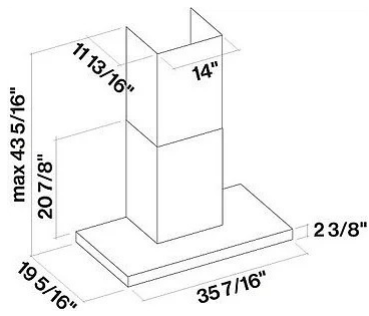

OPTIONAL ACCESSORIES

Code	Description
KACL.921	High Performance Filter
KACL.570#I	Extension H700 Wall - Inox
KACL.571#I	Extension H960 Wall - Inox
KACL.815	Protective cleaning cloths for stainless steel (box 10 pcs)
KACL.400	Silent / Conveyor NRS
KACL.1039	Carbon.Zeo Microtech renewable filter

ENGINE SPECIFICATIONS

Motor speed	1	2	3	4
Noise dB(A) re1pW I.E.C. 60704-2-13	37	41	46	54,5
Capacity	220	290	375	610
Maximum pressure (Pa)	390	440	490	510
Motor power (W)	130	150	178	224
Air outlet	150	150	150	150

CAPACITY / PRESSURE

