

Version FNZEU30W6SS / Wall 30" (76cm) - 600 CFM
Collection Silence - NRS

FEATURES AND PROPERTIES

Materials/Finishes Scotch brite stainless steel (AISI 304)
Technology NRS technology for a quieter kitchen
Control Touch control
Ducting type Extracting/Filtering
Installation type Wall
Lighting Led 2x1,2 W - 3200 K
Filters Charcoal filter (optional)
 Professional Baffle Filters

Ducting type
Dimensions 30 in
Minimum Electric hob distance 21 in
Minimum Gas hob distance 25 in
Notes Recommended mounting height from cooking surface to hood bottom: 24" - 35"

ELECTRICAL CONNECTION AND CONSUMPTION

Maximum consumption 340 W
Voltage/Frequency 110-120V 60Hz
Connection type Hood comes standard with Nema 5-15P power cord

BLOWER PERFORMANCE

Motor 600 CFM
Minimum sound level 0 dB (A)re1pW I.E.C. 60704-2-13
Maximum sound level 0 dB (A)re1pW I.E.C. 60704-2-13

WEIGHTS AND DIMENSIONS

Gross weight 112 lbs
Net weight 91 lbs
Volume 25 ft
Packaging dimensions L 41 x H 28 x D39 in



Photograph is for information purposes only. May not correspond to the selected version

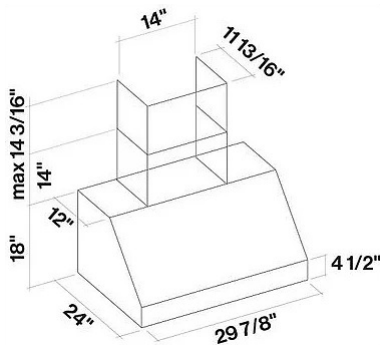

OPTIONAL ACCESSORIES

<i>Code</i>	<i>Description</i>
KACL.570#I	Extension H700 Wall - Inox
KACL.571#I	Extension H960 Wall - Inox
KACL.948#IF	Filter unit for t-shaped wall hoods
KACL.953#BF	Carbon.Zeo filter unit kit for ceiling (vertical outlet)