

FQ50UFXE



Product family	Refrigerator
Installation	Free-standing
Category	2 doors & 2 drawers
No-frost system	Total
Cooling type	Fan-assisted refrigerator, no-frost freezer
Defrost	Automatic
Hinge	Standard
EAN code	8017709255275



Aesthetic



Aesthetics	Universal	Logo color	Silver
Color	Stainless steel	Side material	Steel
Finishing	Fingerprint-proof	Side color	Silver
Design	Flat	Logo	Applied
Material	Steel	Door shelf profile color	Silver
Door stainless steel type	Fingerprint-proof	Drawers profile color	Silver
Handle	External	Glass shelf profile color	White
Handle	Fixed	Display	LCD touch
Handle color	Stainless steel		

Refrigerator compartment features



No. of adjustable shelves	2	Type of crisper cover	Glass
Number of fruit and vegetables drawers	2	LifePlus zone - 32°F	Yes
Type of adjustable shelves	Glass	Refrigerator lighting	Yes
Crisper drawer type	Standard	Refrigerator lighting	LED
Crisper cover	Yes		

Refrigerator Inner Door

No. of door shelves with transparent cover 2
 Number of adjustable door shelves 4

No. of bottle shelves 2

Other Refrigerator features



Accessories
MultiFlow

Egg tray
Yes

Fan

Yes

Freezer features

Number of drawers 2

Other Freezer features

Ice maker Automatic

Ice-tray shelf Yes

Other technical features



Display functions

Holiday, Fast-freezing, Child lock, Temperature alarm

MultiZone

Yes

Fast-freezing button

Yes

Door open alarm

Acoustic

Temperature Alarm

Yes

Temperature setting type

Electronic

No. of compressors

1

Refrigerant gas type

R134a

Compressor type

Standard

Refrigerant quantity

6.3 oz

Foam agent

Cyclopentane

Performance / Energy Label

Noise level 45 dB(A) re 1 pW

Electrical Connection

Plug (A) USA & Mexico

Voltage (V) 115 V

Electrical connection rating 160 W







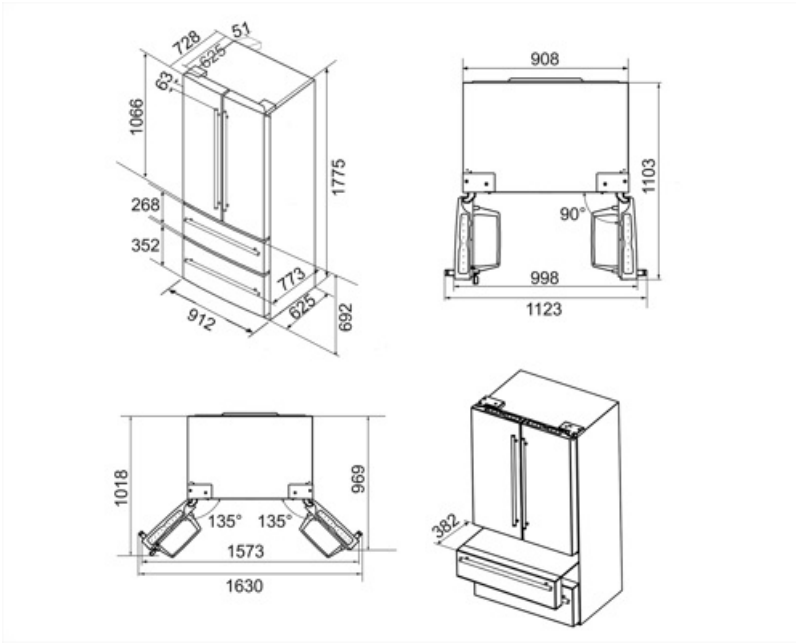





Frequency (Hz) 60 Hz

Current 2.7 A

Power cord length 66 15/16 "



Symbols glossary (TT)

	4 stars freezing compartment for better food preservation.		The automatic defrost system works by automatically defrosting at regular intervals eliminating the need to defrost altogether.
	Child lock: some models are fitted with a device to lock the programme/cycle so it cannot be accidentally changed.		LCD display: to optimize performance and simplify the use of the appliance.
	Ventilated: Forced distribution of cold air in the refrigerator compartment, which allows even temperature distribution within the fridge.		Fast freezing: The fast freezing function brings the temperature of the compartment down when activated a few hours prior to usage.
	Fingerprint proof stainless steel: Fingerprint proof stainless steel keeps stainless steel looking as good as new.		Power saving mode: The power saving mode allows you to disable the refrigerator and keep the freezer working.
	LED interior lighting: is a more energy efficient and long lasting way of illuminating the interior of the appliance.		Life Plus 0°C: The temperature in the Lifeplus compartments is kept at 0°C, which preserves fresh meat and fish longer.
	Air plus: keeps food fresher for longer.		No Frost: The No Frost and Frost free systems prevent ice from forming so that no defrosting is required.