

FZU36LX



Product family	Freezers
Installation	Built-in
Category	One Door
Cooling type	No-frost
Hinge	Door-to-door
Hinge position	Left



Aesthetic

Aesthetics	Classic	Handle	Fixed
Color	Stainless steel	Handle color	Stainless steel
Material	Stainless steel	Side material	Metal
Door stainless steel type	Normal	Logo	Applied
Handle	External	Display	TFT



Freezer features

Freezer lighting	Yes
Freezer lighting	Incandescent light
Number of drawers	4

Other Freezer features

Ice maker	Automatico
-----------	------------

Other technical features

			Display functions	Holiday, Fast-freezing	Type of temperature control	Electronic
			Fast-freezing button	Yes	No. of compressors	1
			Power-on light	Yes	Refrigerant gas type	R600a
			Temperature alarm light	Yes	Type of compressor	Inverter
			Door-open alarm	Yes		

Temperature Alarm	Yes	Refrigerant quantity	85 oz
		Foam agent	Cyclopentane

Performance / Energy Label



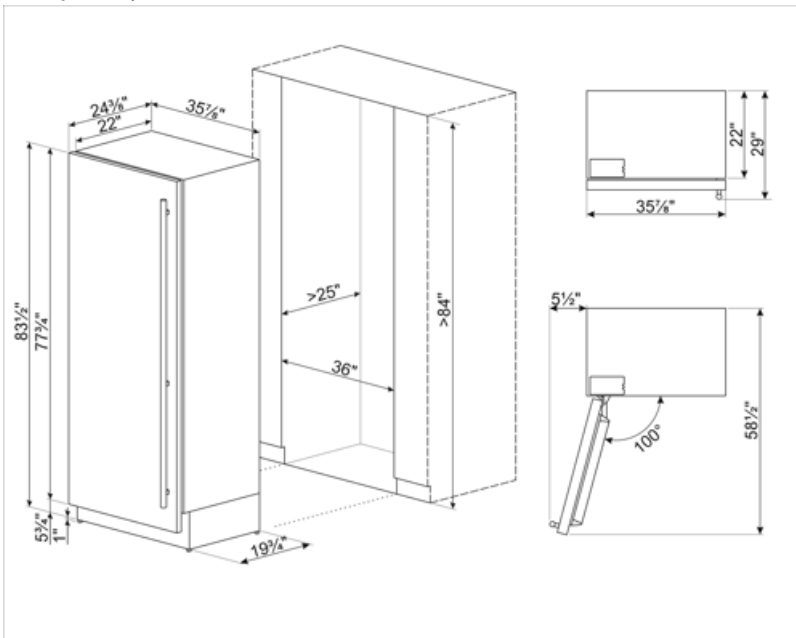

Total volume	150.6 gal	Climatic class	SN, N, ST, T
Sum of the volumes of the frozen compartment(s)	150.6 gal		

Electrical Connection

Current	3,5 A	Power cord length	78 3/4 "
Voltage	115 V	Plug	(B) NEMA 5-15P
Frequency (Hz)	60 Hz		



Symbols glossary

- | | | | |
|--|---|---|---|
|  | <p>Fast freezing: The fast freezing function brings the temperature of the compartment down when activated a few hours prior to usage.</p> |  | <p>Power saving mode: The power saving mode allows you to disable the refrigerator and keep the freezer working.</p> |
|  | <p>Inverter technology: The evolution of Smeg's driers towards more intelligent and environmentally sustainable models has led to the choice of using Inverter technology with heat pumps, which reduces significantly energy consumption.</p> |  | <p>No Frost: The No Frost and Frost free systems prevent ice from forming so that no defrosting is required.</p> |