



MARVEL



OWNER'S GUIDE & SERVICE MANUAL

MARVEL UNDERCOUNTER REFRIGERATION

Model: MARE224-IS51A

# WELCOME

## Welcome to the Marvel Experience!

Thank you for choosing our quality American-built product to add to your home. We are thrilled to welcome you to our growing community of Marvel owners, who trust in our products and our support.

The information in this guide is intended to help you install and maintain your new Marvel undercounter model to protect and prolong its lifetime. We encourage you to contact our Technical Support team at (616) 754-5601 with any questions.

## Got a Marvelous Design?

We would love to see how your Marvel product looks in its new home. You can send us photos of your installed product at [marketing@marvelrefrigeration.com](mailto:marketing@marvelrefrigeration.com), and we might feature your Marvel home design on our website and social media!

## Warranty Registration

It is important you register your product warranty after taking delivery of your appliance. You can register online at [www.marvelrefrigeration.com](http://www.marvelrefrigeration.com).

The following information will be required when registering your appliance:

Serial Number  
Date of Purchase  
Dealer's Name and Address

Online registration  
available at  
[marvelrefrigeration.com](http://marvelrefrigeration.com)

The serial number can be found on the serial plate which is located inside the cabinet on the left side near the top.

<b>Serial Plate Location</b> <small>Typically adhered to top-right inside of unit</small>	<b>MARVEL</b> <small>GREENVILLE, MI 48838</small>	
	<b>MODEL NO: MLBV224-SS01A</b> <b>SERIAL NO: 1911111010001</b> <b>115 V 60 Hz 1.0 A 1 PHASE</b> <b>35 G R600A</b> <b>FACTORY ID: 111111</b>	

# TABLE OF CONTENTS

---

**Tip:** Click on any section below to jump directly there

## Installation

[Integrated Panel Dimensions](#)

[Integrated Panel Installation](#)

# INTEGRATED PANEL DIMENSIONS

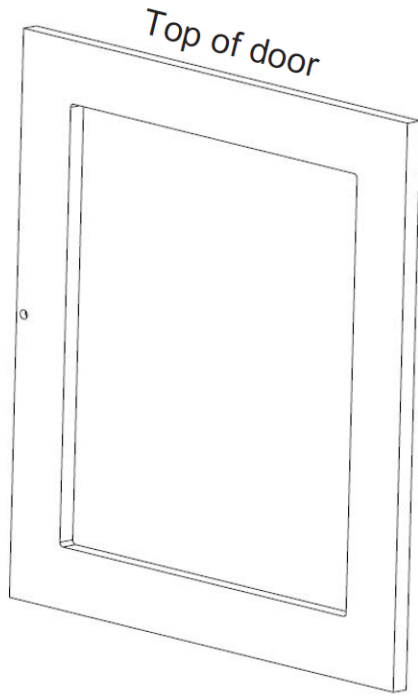

24" (60 cm) wide appliance

## NOTE

- Panel thickness may be  $\frac{5}{8}$ " or  $\frac{3}{4}$ "
- Center the unit in the 24" opening
- If the hinge side of the product is pressed against the adjacent cabinet, use a  $\frac{5}{8}$ " thick panel
- The window cutout is for glass door models only
- Do not use a solid door panel on a glass door model

Door Type	Maximum Panel Weight
Solid	15 lbs
Frame Glass	10 lbs

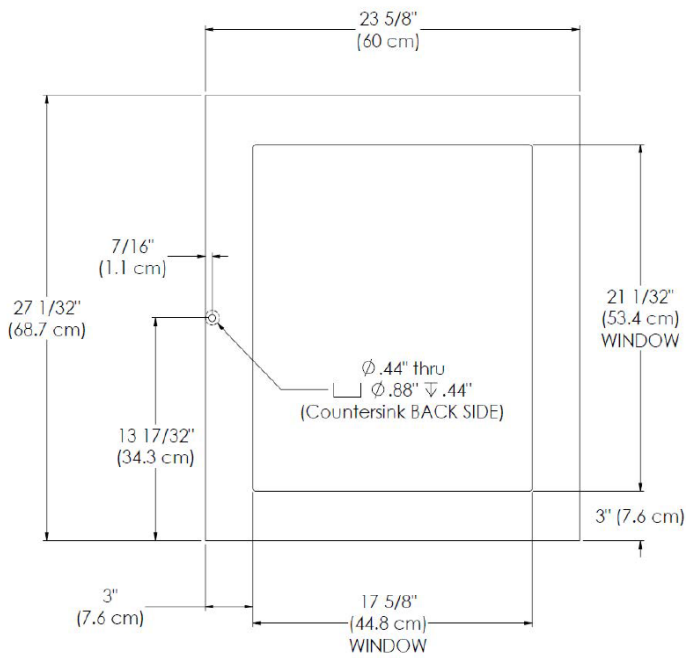

24" (60 cm)  
Door Dimensions

# INTEGRATED PANEL INSTALLATION

Cut and prepare panels according to the information provided in the Integrated Panel Dimensions section.



It is important to use the factory provided grille that came with the product to assure proper air flow is maintained through the condenser. The use of a custom grille is not recommended and will void the warranty.

## Step 1: Removing the Door and Hinges

Hold the door secure in the closed position and remove Hinge Pin from the Upper Hinge using a 1/8" Hex Key tool. Slowly remove the door by sliding outward away from the cabinet and lift to remove off the Lower Hinge. If reversing the door, remove hinges from cabinet per Door Reversal Instructions.

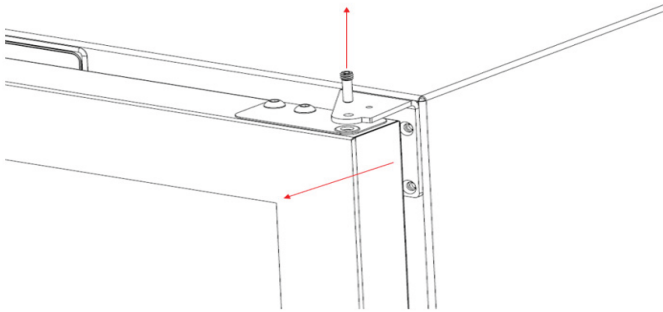

Remove the hinge bushing from the adaptor plate. A new bushing is included in the literature pack with your unit.

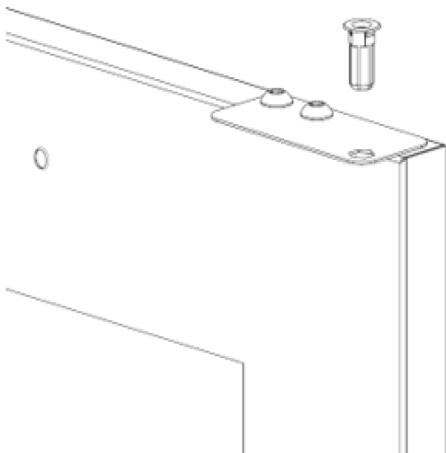

## Step 2: Remove the door gasket

With the door laying on a flat surface and starting at a corner of the door, remove the magnetic door gasket from the interior side of the door. Set the gasket aside on a flat surface.

There are 10 holes in the gasket retainer extrusions (3 on each side and 2 at the top and bottom) which are used to fasten the panel to the front of the door. The screws are provided in the literature pack.

## Step 3: Assemble the panel to the door

The preferred method of attaching the panel to the door is to clamp the panel to the door so it cannot move while drilling the screw pilot holes. Use bar clamps or "C" clamps with pads on the clamping surfaces that will not mar the panel or the door. The custom panel should be flush with the top of the door and centered along the width of the door. Drill holes through the gasket extrusion using the 10 holes as pilot holes. Use the drill size from the chart in the table below being careful not to drill through the front surface of the panel. Fasten the panel to the door with the 10 screws provided in the literature pack. Remove the clamps and replace the gasket in the gasket extrusion channels of the door. Some force may be required to seat the gasket into the channels. Be sure the gasket corners are seated properly.



Material Type	#10 Wood Screw
Hardwood	1/8" (3.2 mm) Diameter. Pilot Hole
Softwood	7/64" (2.8 mm) Diameter. Pilot Hole

# INTEGRATED PANEL INSTALLATION

---

## Step 4: Install the Door

If reversing the door swing, reinstall hinges per Door Reversal Instructions. Carefully slide lower hinge bushing over bottom hinge pin. Install the new upper hinge bushing into adaptor plate.

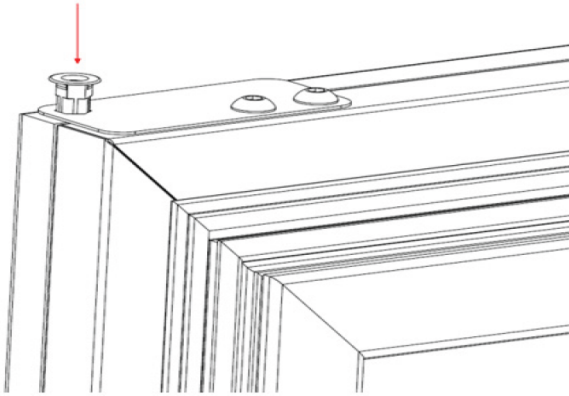

Align hinge bushing with top hinge and reinstall upper hinge pin using 1/8" Hex Key so that the pin is flush.