

DF

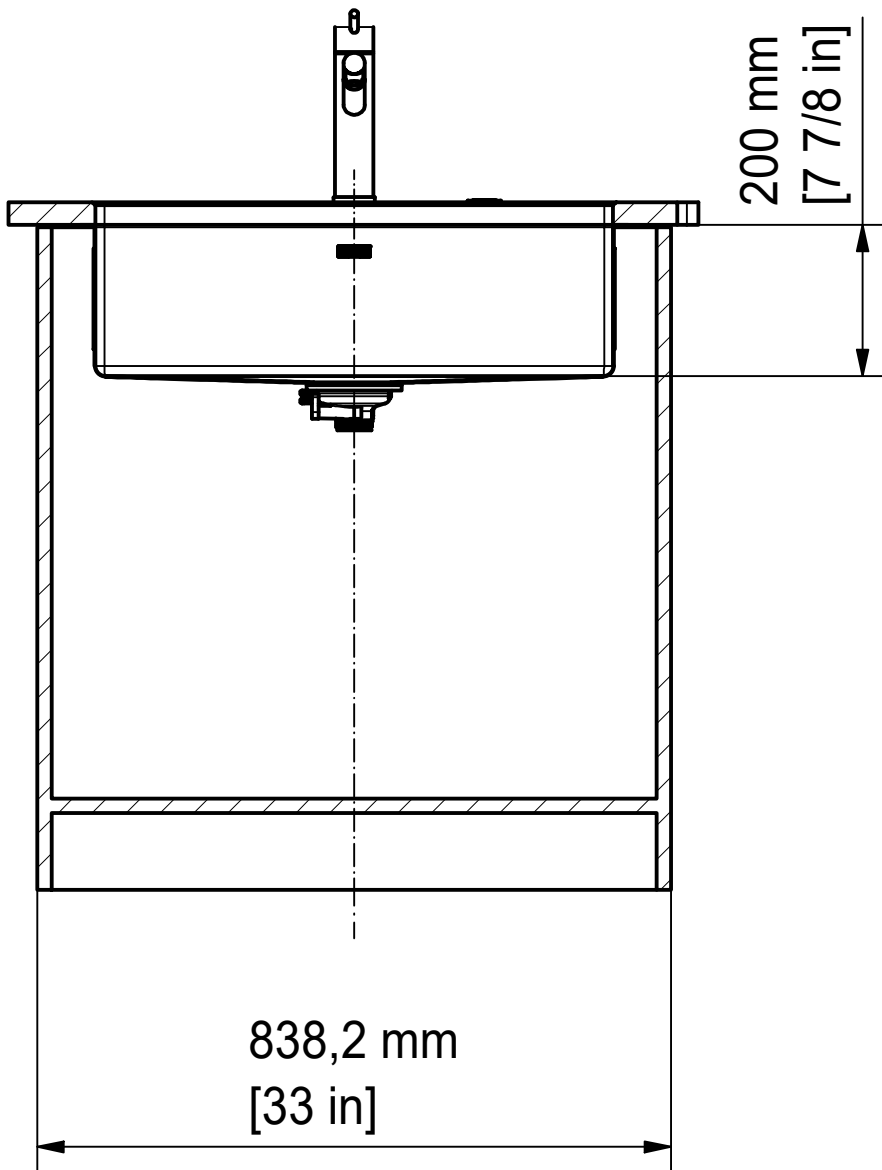

Drawing No.	20250295_02	Revision	A
Drawn Date	21.03.2023		
These drawings and specifications are the property of Franke Technology and Trademark Ltd., Hergiswil, Switzerland.			



BXM 110-68 SI
Installing Document

Sheet	Sheets
1	6

DS

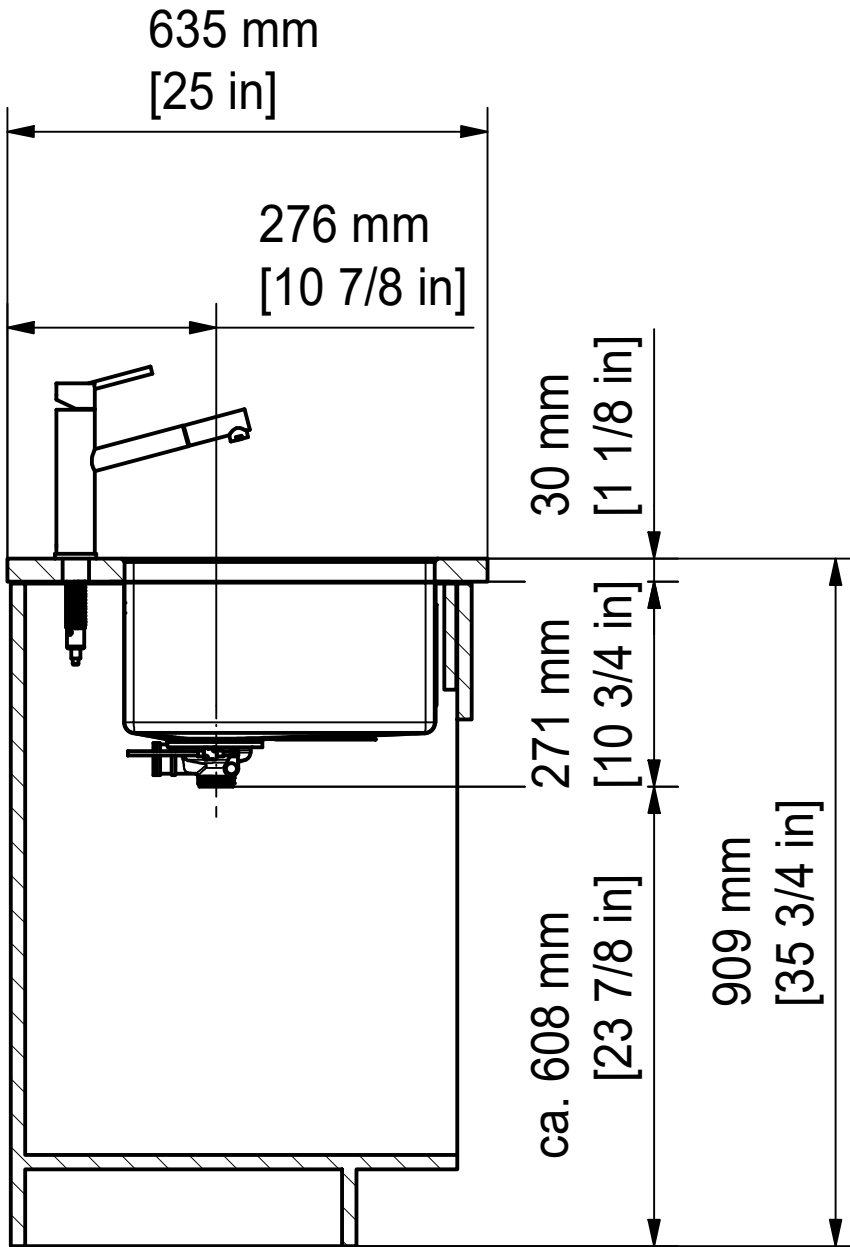

Drawing No.	20250295_02	Revision	A
Drawn Date	21.03.2023		
These drawings and specifications are the property of Franke Technology and Trademark Ltd., Hergiswil, Switzerland.			



BXM 110-68 SI
Installing Document

Sheet	Sheets
2	6

CO

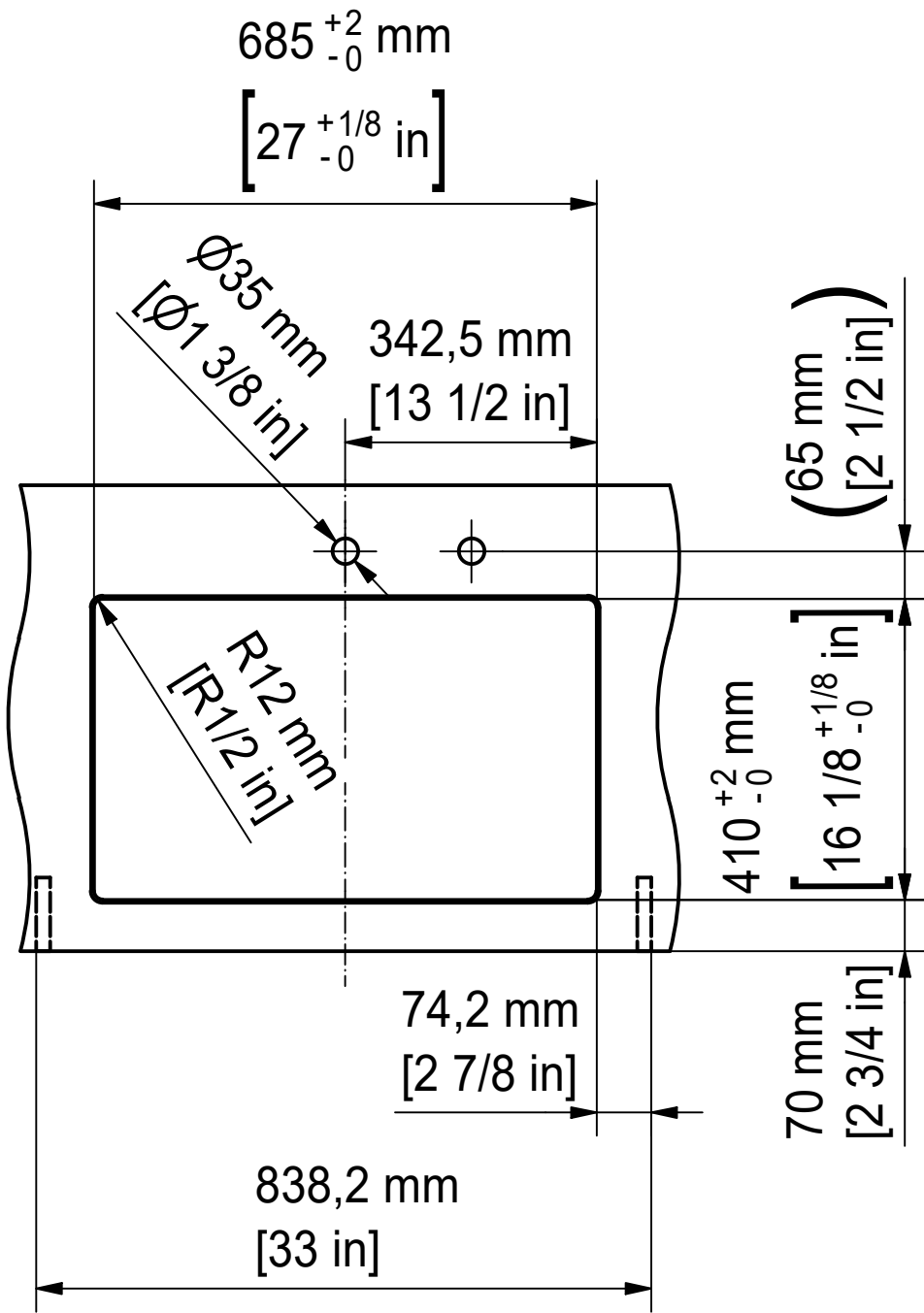

Drawing No.	20250295_02	Revision	A
Drawn Date	21.03.2023		
These drawings and specifications are the property of Franke Technology and Trademark Ltd., Hergiswil, Switzerland.			



BXM 110-68 SI
Installing Document

Sheet	Sheets
3	6

CNC



Drawing No.	20250295_02	Revision	A
Drawn Date	21.03.2023		
These drawings and specifications are the property of Franke Technology and Trademark Ltd., Hergiswil, Switzerland.			



BXM 110-68 SI
Installing Document

Sheet	Sheets
4	6

DT

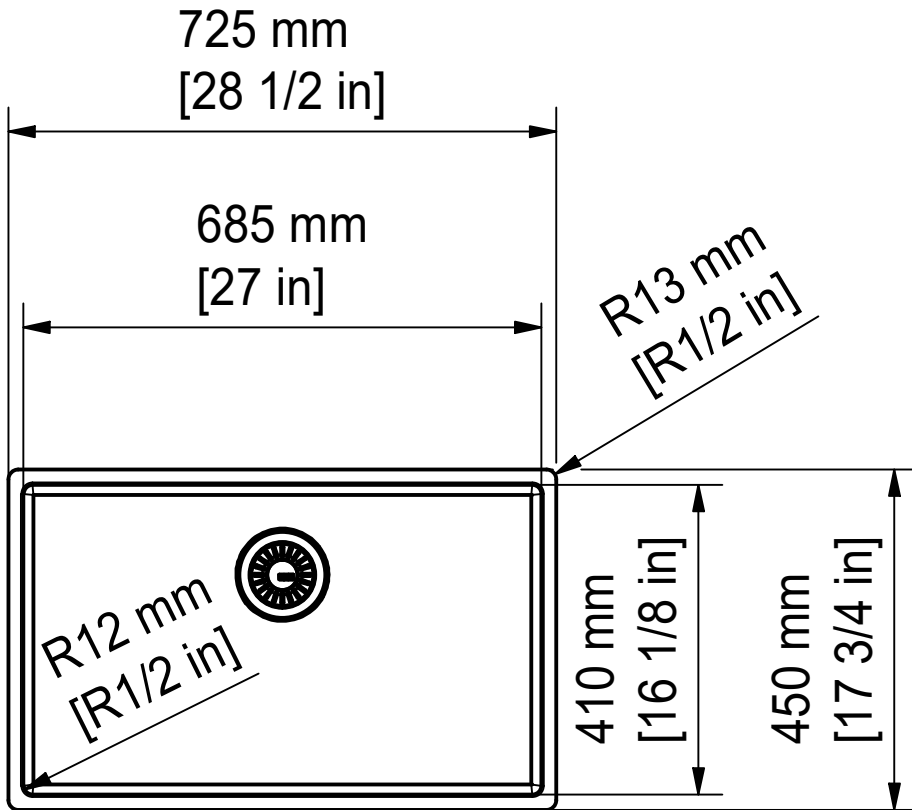

Drawing No. 20250295_02 Revision A

Drawn Date 21.03.2023

These drawings and specifications are the property of Franke Technology and Trademark Ltd., Hergiswil, Switzerland.



BXM 110-68 SI
Installing Document

Sheet Sheets

5 6

ISO

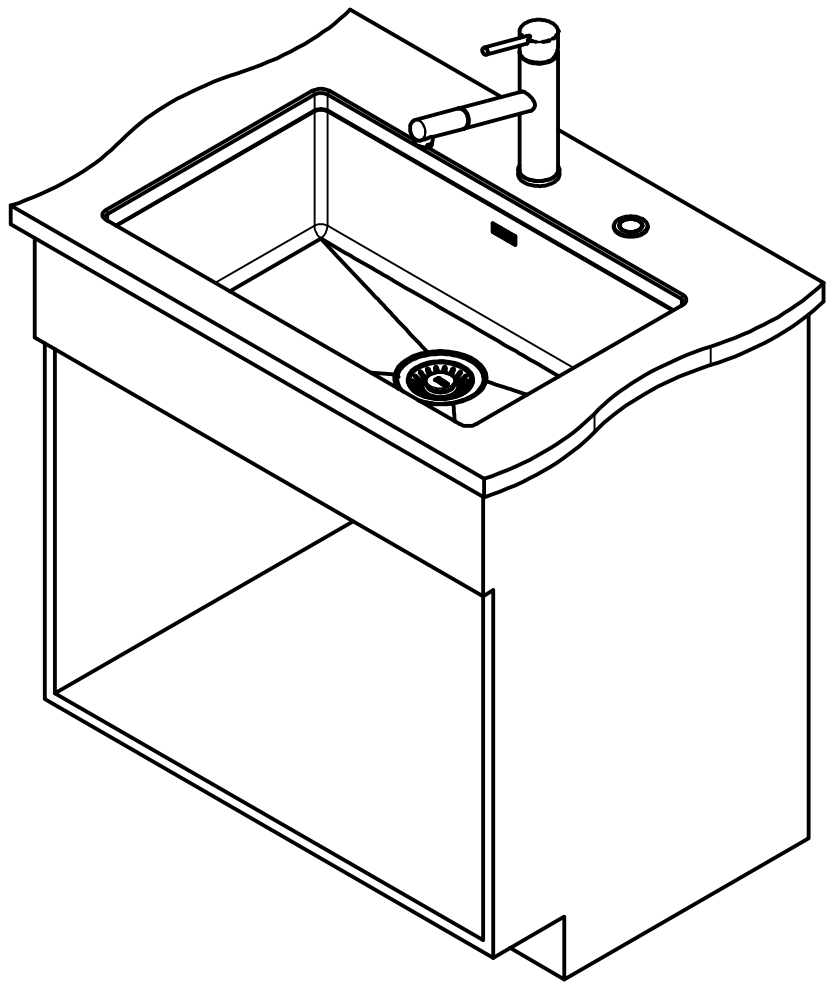

Drawing No. 20250295_02 Revision A

Drawn Date 21.03.2023

These drawings and specifications are the property of Franke Technology and Trademark Ltd., Hergiswil, Switzerland.

FRANKE

BXM 110-68 SI
Installing Document

Sheet Sheets

6 6