



## NEW 36"W. INTEGRATED BOTTOM-FREEZER

FDBMIC

### PROFESSIONAL FEATURES

- Uniform air circulation maintains consistent temperatures
  - Ensures food stored in different compartments gets equal treatment
  - Maintains temperature to within 1°F to keep food fresher longer
- Extremely quiet dual compressor system with electronic controls
- Compressor located on the bottom allows for full integration of the product
- Temperature Range
  - Refrigerator Compartment: 34°F (1°C) to 45°F (7°C)
  - Freezer Compartment: 9°F (-13°C) to -9°F (-23°C)
- *Triple Mode Convertible Drawers* provide total flexibility with drawers that can switch between a refrigerator, fresh food space, or freezer, allowing for adaptation of food storage
- Antibacterial stainless steel interior crisper drawers
  - Stainless steel non-porous surface is micro peened to resist bacteria and germs
  - Helps maintain high food quality and shields against the spread of bacteria
  - Inside corners of drawers have a radius for easy cleaning
- Crisper drawers operate at a temperature 2°F to 3°F lower than the rest of the refrigerator
- State-of-the-art closing system ensures refrigerator crisper drawers close smoothly and quietly
- **EXCLUSIVE** *PlasmaCluster™ Ion Air Purifier* utilizes advanced ion technology to eliminate airborne bacteria, mold, and odors
- Innovative touch control maintains consistent temperature in the compartments
- Easy user interface allows for personalization of settings
  - Special Modes include Max Refrigerator, Max Freezer, Max Ice, Vacation, Sabbath, Triple Mode Convertible Drawer
- Side and top mounted energy-efficient LED lighting enhances visibility
- Dual size ice maker
  - Easily switch between medium and large ice cubes
  - Max Ice Mode temporarily increase ice cube production for 24 hours
  - Water filter provides pure water for ice production
- *Patented Easy Lift Shelf Position System* adds storage flexibility
- Two adjustable glass shelves, one fixed glass shelf, three adjustable door bins



**FDBMIC7360R**  
(shown with custom panel)

### DESIGN FEATURES

- *Proprietary Fully Articulating Hinge* has three-dimensional adjustability for a perfect fit in integrated installations
- Hinge damper allows for smoothness when opening and closing door
- Unit is custom panel ready to accept matching cabinetry panels or the Viking Professional and RVL Door Panel Kits

### MODEL NUMBERS

- FDBMIC7360L – 36"W. Integrated Bottom-Freezer, Custom Panel; Left Hinge
- FDBMIC7360R – 36"W. Integrated Bottom-Freezer, Custom Panel; Right Hinge

### ACCESSORIES

- PHK528-SS – Professional Stainless Steel handle (1 piece/28")
- RWFIC – Replacement Water Filter

### WARRANTY

- 2-year full covers complete unit
- 6-year full – sealed refrigeration system
- 90-day full – cosmetic parts such as glass, painted items, and decorative items
- 12-year limited – sealed refrigeration system



# NEW 36"W. INTEGRATED BOTTOM-FREEZER

FDBMIC

## PROFESSIONAL DOOR PANEL KITS

- V1736BDPL\* – 36"W. Integrated Bottom-Freezer Door Panel Kit with Handle, Left Hinge
- V1736BDPR\* – 36"W. Integrated Bottom-Freezer Door Panel Kit with Handle, Right Hinge

## DOOR PANEL COLOR FINISHES\*

- Stainless Steel (SS)



- Available in 18 Exclusive Color Finishes: Antique Bronze (AN), Blush (BH), Cast Black (CS), Daffodil (DA), Damascus Gray (DG), Eucalyptus (EU), Golden Hour (GH), Ivy (IV), Martini (MA), Nantucket (NA), November Sky (NS), Onyx (ON), Pure White (PW), Slate Blue (SB), Spiced Cider (SC), Splash (SP), Squall (SQ), and Valentine (VA)



## RVL DOOR PANEL KITS

- MVI636BDPL\*\* – 36"W. Bottom-Freezer Door Panel Kit with Handle, Left Hinge
- MVI636BDPR\*\* – 36"W. Bottom-Freezer Door Panel Kit with Handle, Right Hinge

## RVL DOOR PANEL FINISHES\*\*

- Black Glass (BG) and Stainless Steel (SS)



### 36"W. INTEGRATED BOTTOM-FREEZER

DESCRIPTION	FDBMIC7360	
Overall Width	35-7/8" (91.2 cm)	
Overall Height (from bottom)	83-1/2" (212.1 cm) min. to 84-1/2" (214.6 cm) max.	
Overall Depth from Rear	To front edge of side trim: 22" (56.0 cm) To front of top grille: 24" (61.0 cm)	
Cutout Width	36" (91.4 cm)	
Cutout Height	84" (91.5 cm) min. to 84-1/16" (213.5 cm) max.	
Cutout Depth	24" (61.0 cm) plus panel thickness	
Electrical Requirements	115 volt, 60 Hz, 15 amp dedicated circuit; 3-wire cord with grounded 3-prong plug attached to product	
Maximum Amp Usage	9.9 amps	
Maximum Panel Weight	Fresh food 45 lbs. (20.4 kg)	Freezer 20 lbs. (9.0 kg)
Inlet Water Requirements	1/4" copper tubing inlet waterline; minimum 20 psi; maximum 120 psi	
Overall Interior Capacity	19.4 cu. ft. (549.3 L)	
Approximate Shipping Weight	467 lbs. (211.8 kg)	

Please do not prepare installation from brochure data only. See installation instructions for important clearance/installation information.



# NEW 36"W. INTEGRATED BOTTOM-FREEZER

FDBMIC

## INSTALLATION CUTOUT FEATURES: PANEL-READY

- A** **Minimum cutout height**  
84" (213.4 cm)
- Cutout width**  
36" model: 36" (91.4 cm)
- Minimum cutout depth**  
24" (61.0 cm) + panel thickness for flush installation
- Area to be left clear for the anti-tipping brackets**  
5" (12.7 cm) for both right and left sides

- B** **Appliance height**  
83-1/2" (212.0 cm) + 1" (2.5 cm)

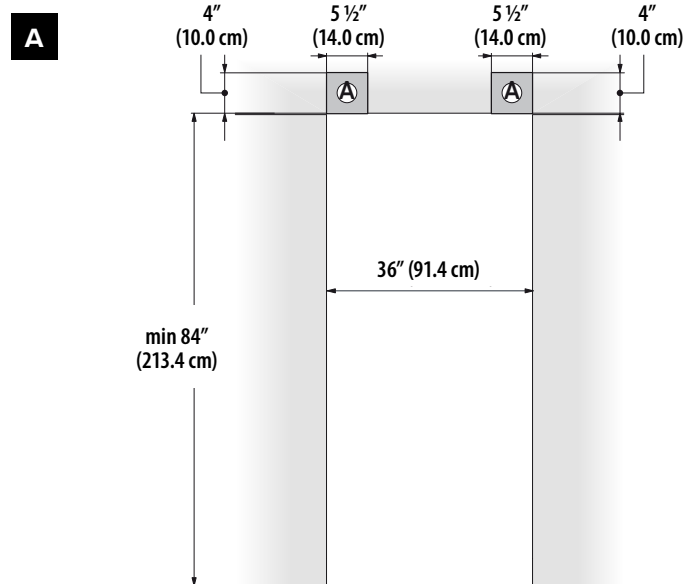

## WIDTH OF APPLIANCE BODY

36" model: 34 7/8" (88.5 cm)

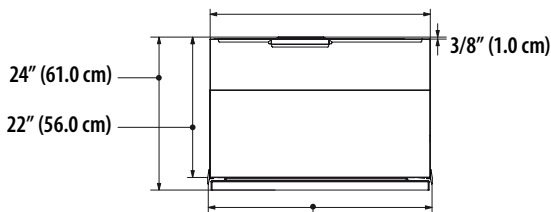

36" model: 35 7/8" (91.2 cm)  
Width of appliance with mounting brackets installed (effective width)

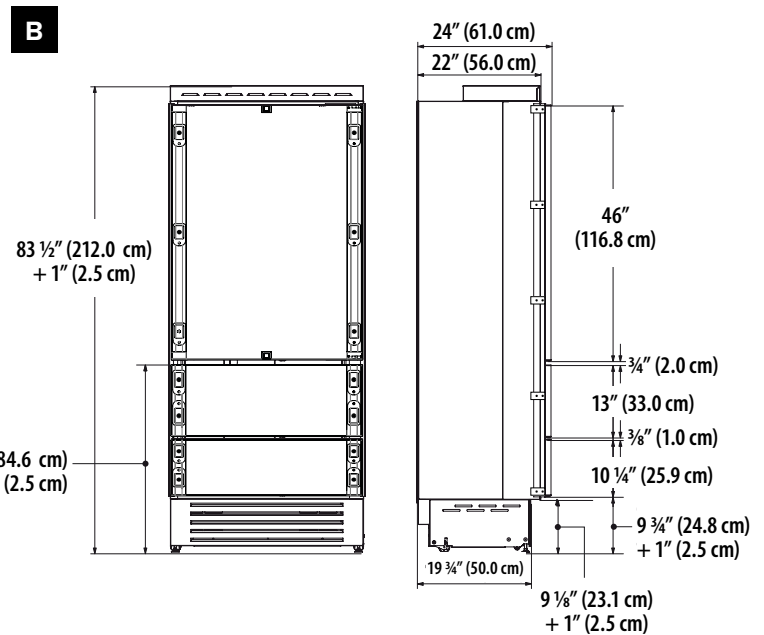



# NEW 36"W. INTEGRATED BOTTOM-FREEZER

FDBMIC

WIDTH	DOOR/DRAWER WIDTH A
36"	35-3/4 (90.8 cm)

Panels with thickness ranging between 3/4" (1.9 cm) and 1-1/8" (2.8 cm). The maximum door panel weight is 51 lbs. (23 kg), and the maximum drawer panels weight is 25 lbs. (11 kg).

## CUTOUT DIMENSIONS FOR COMBINED INSTALLATION

		A			
		18"	24"	30"	36"
B	18"	36" (91.4 cm)	42" (106.7 cm)	48" (122.0 cm)	54" (137.2 cm)
	24"	42" (106.7 cm)	48" (122.0 cm)	54" (137.2 cm)	60" (152.0 cm)
	30"	48" (122.0 cm)	54" (137.2 cm)	60" (152.0 cm)	66" (167.6 cm)
	36"	54" (137.2 cm)	60" (152.4 cm)	66" (167.6 cm)	72" (182.9 cm)

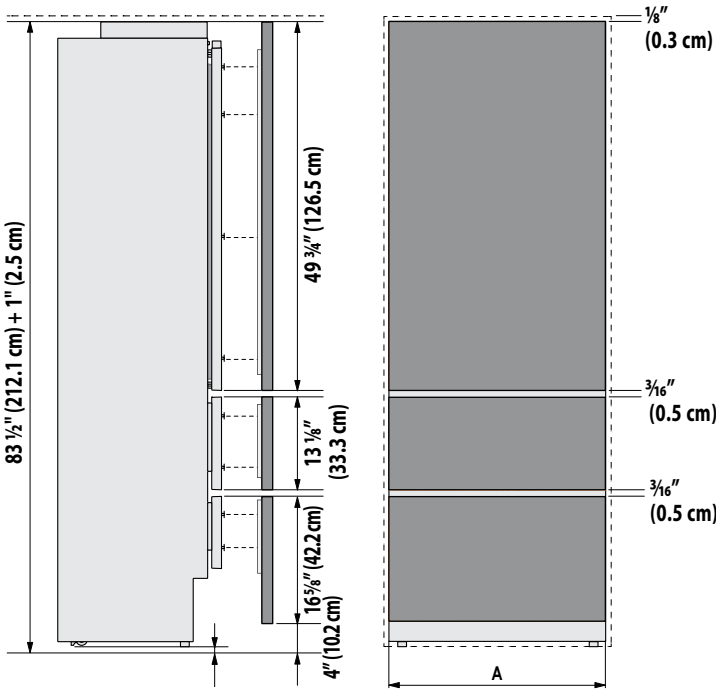
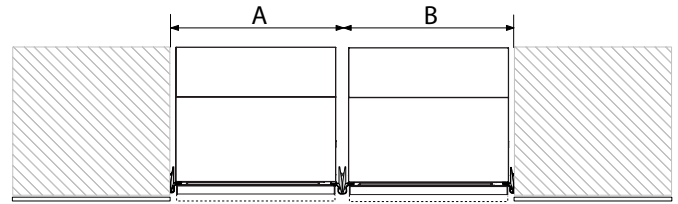

## DOOR-SWING CLEARANCE

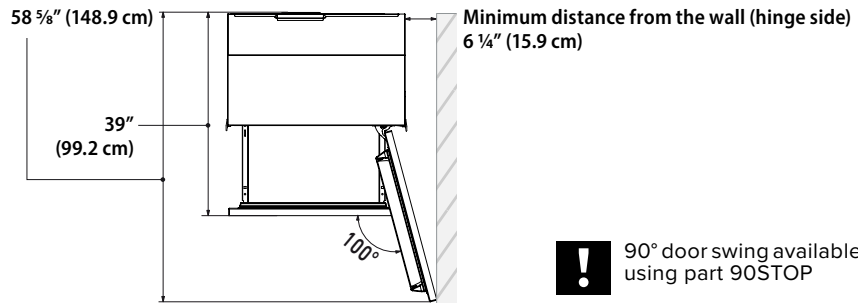

**!** 90° door swing available using part 90STOP



VIKING RANGE, LLC 111 FRONT STREET GREENWOOD, MISSISSIPPI 38930 USA

For detailed product information, model numbers, or to request a quote call 1-888-845-4641 or visit [vikingrange.com](http://vikingrange.com)  
 © 2025 Viking Range, LLC All rights reserved. Specifications subject to change without notice.

