

Professional 2.0 Sink - PS2X110-18 | 122.0530.830

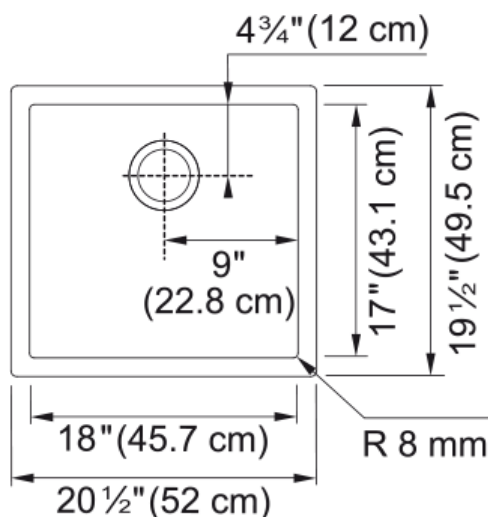

20.5-in. x 19.5-in. 16 Gauge Stainless Steel Single Bowl Kitchen Sink. The Professional sink collection boasts refined touches for the home chef. Deeper bowls are undermounted to integrate beautifully into the surrounding worktop. We didn't sacrifice aesthetics for durability, made of 16-gauge commercial-grade stainless steel and a beautiful finish that takes minimal care to maintain a clean, attractive look. Available in a variety of size and configuration options, Professional is sure to work into your kitchen area and bring everything a cook requires.

Aspect

Sink type	Sink
Type of material	Stainless steel
Number of bowls	1
Color	Steel
Surface finish	Pearl

Product Dimensions

Length (right to left)	20.472
Width (front to back)	19.488
Large bowl size: right to left	18
Large bowl size: front to back	17
Large bowl: depth	10

Installation

Minimum cabinet size	24"
----------------------	-----

Product specifications

Installation type	Undermount
Drain hole	3 1/2"
Position of drainer	No drainer

Product identification

Product brand	FRANKE
Product family	None
Collection	Professional Series
Certified by	IAPMO

Features

Drainers number	No drainer
Product reversibility	No
Faucet ledge	No

Strainer assembly included	No
Strainer Assembly	No waste kit
Overflow	No
Number of faucet holes	No faucet hole
Soap dispenser hole	No