

# RBMU30RX



<b>Product family</b>	Refrigerator
<b>Installation</b>	Built-in
<b>Category</b>	Bottom mount
<b>Built-in niche</b>	>200
<b>Reference width</b>	70 - 80
<b>Reference height</b>	Higher than 200
<b>No-frost system</b>	Total
<b>Cooling type</b>	Total no-frost - Dual-flow cooling system
<b>Defrost</b>	Automatic
<b>Hinge</b>	Door-to-door
<b>Hinge position</b>	Right
<b>EAN code</b>	8017709332686



## Aesthetic

<b>Aesthetics</b>	Universal	<b>Side material</b>	Steel
<b>Color</b>	Stainless steel	<b>Logo</b>	Applied
<b>Material</b>	Steel	<b>Door shelf profile color</b>	Silver
<b>Door stainless steel type</b>	Normal	<b>Drawers profile color</b>	Silver
<b>Handle</b>	External	<b>Glass shelf profile color</b>	Silver
<b>Handle</b>	Fixed	<b>Display</b>	TFT
<b>Handle color</b>	Stainless steel	<b>Display position</b>	Internal
<b>Logo color</b>	Stainless steel	<b>Water filter</b>	Yes

## Refrigerator compartment features



<b>No. of adjustable shelves</b>	3	<b>Crisper cover</b>	Yes
<b>Number of fruit and vegetables drawers</b>	2	<b>Type of crisper cover</b>	Glass
<b>Type of adjustable shelves</b>	Glass	<b>Refrigerator lighting</b>	Yes
<b>Crisper drawer type</b>	Sliding crisper	<b>Refrigerator lighting</b>	LED

## Refrigerator Inner Door

<b>Number of adjustable door shelves</b>	3	<b>Adjustable door bins with wire support</b>	Yes
--	---	---	-----

## Other Refrigerator features



MultiFlow Yes

## Freezer features

Number of drawers	1	Freezer lighting	Yes
No. of lights	2	Freezer lighting	LED

## Other Freezer features

Ice maker	Automatic	Ice-tray shelf	Yes
-----------	-----------	----------------	-----

## Other technical features



Display functions	Holiday, Fast-freezing, Fast-cooling, Temperature alarm, Showroom mode, Sabbath
Water network connection	Yes
Power-on light	Yes
Temperature alarm	Yes
Door open alarm	Yes
Temperature Alarm	Yes
Temperature setting type	Electronic
No. of compressors	2
Refrigerant gas type	R600a
Compressor type	Inverter
Refrigerant quantity	3.7 oz
Foam agent	HFO

## Performance / Energy Label

Annual energy consumption	502 KWh/year	Refrigerator compartment	11.83 cu. ft.
Total volume	15.54 cu. ft.	Total volume	16.28 cu. ft.
Freezer volume	3.71 cu. ft.		

## Electrical Connection



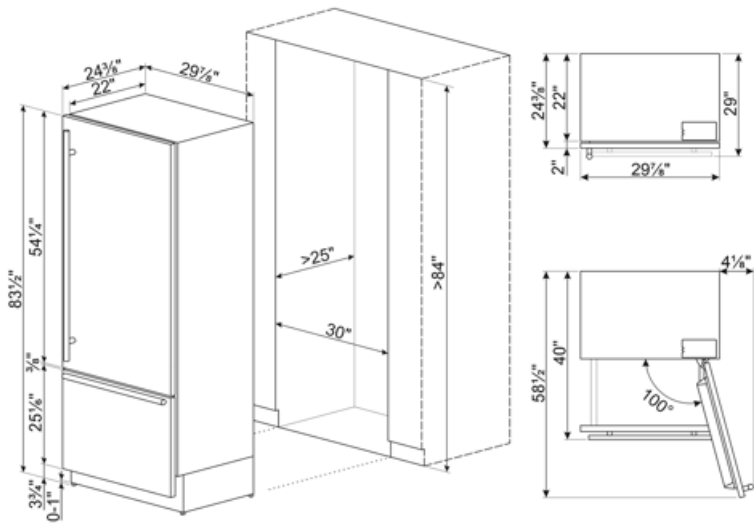



Plug	(B) USA 120V	Frequency (Hz)	60 Hz
Current	3 A	Power cord length	78 3/4 "
Voltage (V)	115 V		



---

## Symbols glossary (TT)

---

- |  |   |   |   |
|--|---|---|---|
|  | The automatic defrost system works by automatically defrosting at regular intervals eliminating the need to defrost altogether.   |  | Fast freezing: The fast freezing function brings the temperature of the compartment down when activated a few hours prior to usage. |
|  | Power saving mode: The power saving mode allows you to disable the refrigerator and keep the freezer working.   |  | LED interior lighting: is a more energy efficient and long lasting way of illuminating the interior of the appliance.               |
|  | Inverter technology: The evolution of Smeg's driers towards more intelligent and environmentally sustainable models has led to the choice of using Inverter technology with heat pumps, which reduces significantly energy consumption. |  | Air plus: keeps food fresher for longer.  |
|  | Sabbath: This function allows you to cook food during the Sabbath, the Holiday of rest in the Jewish religion, respecting the precepts. The oven works  |   |   |