

ZLINE

ATTAINABLE LUXURY[®]

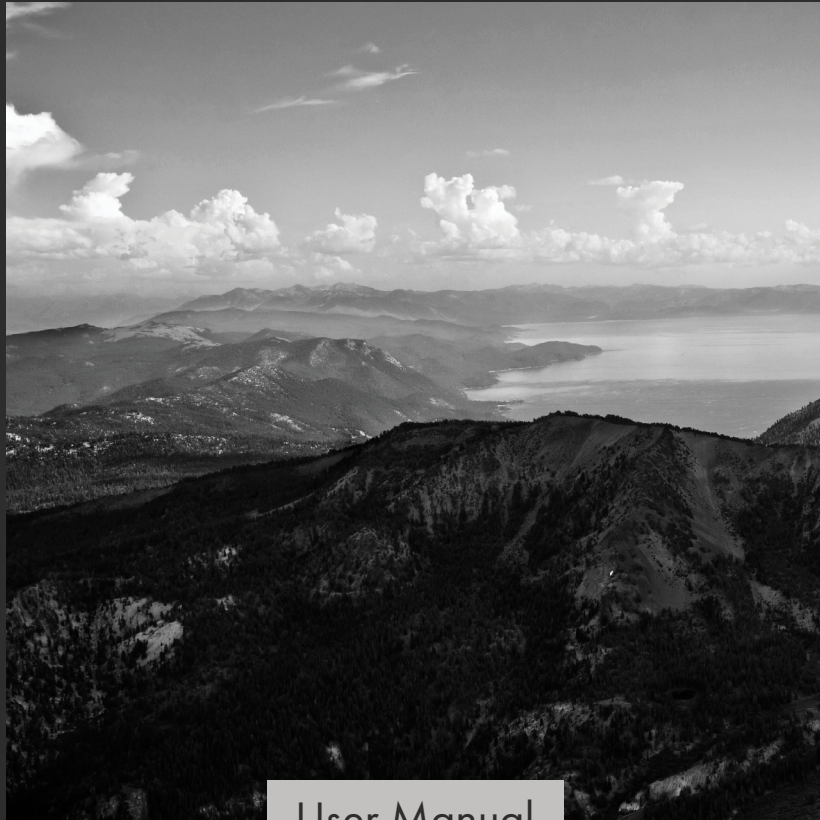

User Manual

FREESTANDING REFRIGERATION COUNTER-DEPTH RFM MODELS

zlinekitchen.com



ZLINE Kitchen and Bath provides Attainable Luxury, where the kitchen and bath of your dreams is never out of reach. Through our unique designs and unparalleled quality, we're dedicated to providing you an elevated experience in the heart of your home. With an endless selection of features and finishes, our inspiration is your reality.

ZLINE
ATTAINABLE LUXURY®



ZLINE is fueled by a passion for innovation—a relentless pursuit of bringing the highest end luxury designs and professional features into everyone’s homes.

Because we continually strive to improve our products, we may change specifications and designs without prior notice.

Scan the QR code to view the most up-to-date version of the Installation Manual and User Manual.

⚠ WARNING: This product can expose you to chemicals including nickel, which is known to the State of California to cause cancer. For more information, go to www.P65Warnings.ca.gov.

TABLE OF CONTENTS

IMPORTANT SAFETY INSTRUCTIONS.....	1
OPERATION	5
MAINTENANCE AND CLEANING.....	10
TROUBLESHOOTING.....	13
WARRANTY.....	16

IMPORTANT SAFETY INSTRUCTIONS

This unit's installation and user manuals contain important safety information. Failure to follow these instructions may result in death, fire, or electric shock.



WARNING:

WARNING

Indicates a potentially hazardous situation which, if not avoided, could result in death or serious injury.



CAUTION:

CAUTION

Indicates a potentially hazardous situation which, if not avoided, may result in injury. It may also be used to alert against unsafe practices.



NOTICE:

NOTICE

Indicates a potentially hazardous situation which, if not avoided, may result in damage to the refrigerator, the tableware, the equipment, or the environment.

GENERAL SAFETY

- **WARNING:** Risk of fire/flammable materials.
- Do not store explosive substances, such as aerosol cans with a flammable propellant, in or near this appliance.
- Children should be supervised to ensure they do not play with the appliance.
- **WARNING:** To avoid safety and suffocation risks for children or pets, before you dispose of your old refrigerator or freezer:
 - Take off the doors and drawers.
 - Leave the shelves in place so that children or pets may not climb inside.
- For refrigerator doors or drawers fitted with locks and keys, the keys should be kept out of the reach of children and not in the vicinity of the appliance in order to prevent children from being locked inside.
- If the electrical supply cord is damaged, it must be replaced by a professional in order to avoid electric shock hazards.
- **WARNING:** When positioning the appliance at its installation location, ensure the electrical supply cord is not kinked or damaged.

IMPORTANT SAFETY INSTRUCTIONS

- The appliance must be unplugged before installing accessories, carrying out any maintenance, and if it will not be used for extended periods of time.
- **WARNING:** Do not use electrical or mechanical appliances inside the food storage compartments of the appliance.
- **WARNING:** Do not use multiple portable electrical outlets or portable power supplies at the rear of the appliance.
- Do not use extension cords or ungrounded (2-prong) adapters when connecting this appliance to electricity.
- **WARNING:** Keep ventilation openings in the appliance enclosure or in the built-in structure clear of obstruction.
- **WARNING:** Do not use mechanical devices or other means to accelerate the defrosting process in this unit.
- **WARNING:** Do not damage the unit's refrigerant circuit and sealed cooling system.
- **WARNING:** To avoid any hazards due to instability of the appliance, adjust the height according to the instructions provided in this manual.
- **WARNING:** Connect this appliance only to a potable water supply.
- Do not arbitrarily disassemble or reconstruct the refrigerator. Do not damage the refrigerant circuit or the sealed cooling system. Maintenance of the appliance must be conducted by a professional service person.

IMPORTANT SAFETY INSTRUCTIONS

- To avoid food contamination, please read the following instructions and information:
 - Opening the door for long periods of time can cause a significant increase in the temperatures inside the appliance.
 - Users should regularly clean surfaces and accessible drainage systems that come in contact with food.
 - Clean water tanks if they have not been used for 48 hours, and flush the water system connected to the water supply if water has not been drawn for 5 or more days.
 - Store raw meat and fish in suitable containers in the refrigerator so that it does not contact with or drip onto other food.
 - If the appliance is left empty for long periods of time, you should disconnect from power, defrost, clean, dry, and leave the door open to prevent mold developing within the appliance.
- The gaps between the doors and between the doors and the refrigerator body are small. Do not to put your hand in these areas. Be gentle when closing the refrigerator door to avoid food or liquids falling or spilling.
- Do not pick up food or containers with wet hands in the freezer compartment when the refrigerator is running, especially metal containers, to avoid frostbite.
- Do not place heavy objects on the top of the refrigerator. Objects may fall when closing or opening the doors, increasing risk of injury.
- Unplug the appliance from electricity in the event of power failure and when performing routine cleaning. When disconnecting from electricity, wait at least five minutes before plugging back in to prevent damages to the compressor and sealed cooling system due to successive stops and starts.

PLACEMENT OF ITEMS

- Do not put flammable, explosive, volatile, or highly corrosive items in the refrigerator or freezer to prevent damage to the product and limit risk of fire or explosion.
- Do not place flammable items near the refrigerator to limit risk of fire or explosion.
- The refrigerator is intended for household use, such as the storage of food; it shall not be used for other purposes, such as storage of blood, drugs, biological products, etc.
- Do not store beer, soda, or other beverages contained in bottles or enclosed containers in the freezing compartment. Bottles or sealed containers may crack or explode due to freezing temperatures and can damage the refrigerator.

IMPORTANT SAFETY INSTRUCTIONS

ENERGY WARNINGS

- Refrigerating appliances might not operate consistently (for example: defrosting of food or warming temperatures inside the freezer compartment) when set below the cold end of the range of temperatures designed for the appliance.
- Effervescent drinks should not be stored in the freezer compartment or in low-temperature compartments or cabinets. Additionally, some products such as ice water should not be consumed too cold.
- Do not exceed storage time(s) recommended by food manufacturers for any kind of food, particularly for commercially quick-frozen food in the freezer compartment.
- It's recommended to wrap frozen food in several layers of parchment paper or newspaper to prevent an undue rise in the temperature while defrosting the refrigerator.
- An increase in temperature of frozen foods during manual defrosting, maintenance, or cleaning could shorten the storage life of the unit.

WARNINGS FOR DISPOSAL

Both the refrigerant (R600a isobutane) and cyclopentane foaming material used for this appliance are flammable. Therefore, when the appliance reaches the end of its service life, it should be kept away from any fire source and be disposed of according to local regulations so as to prevent damage to the environment or other harm.



When the refrigerator is disposed of, disassemble the doors and remove gasket of door and shelves. Put the doors and shelves in a proper place to prevent damage to the environment or any other harm.

Correct disposal of this product: This icon indicates this product should not be disposed with other household wastes. Dispose of the refrigerator according to local regulations, due to the use of flammable blowing gas and refrigerant. To prevent possible harm to the environment or human health from uncontrolled waste disposal, recycle it responsibly to promote the sustainable reuse of material resources.

OPERATION

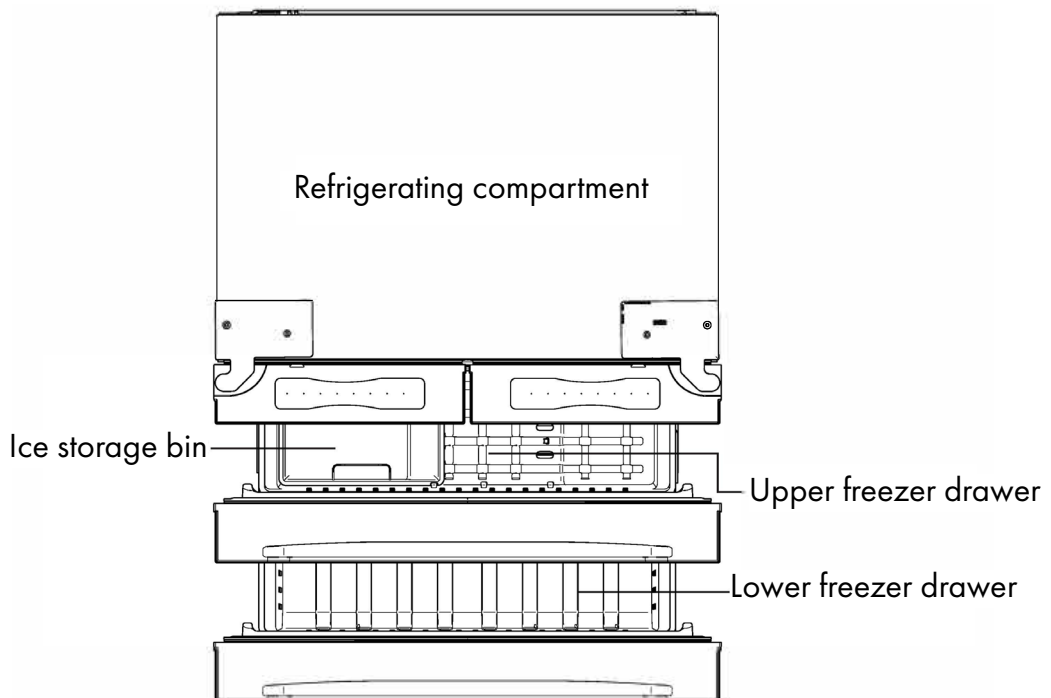
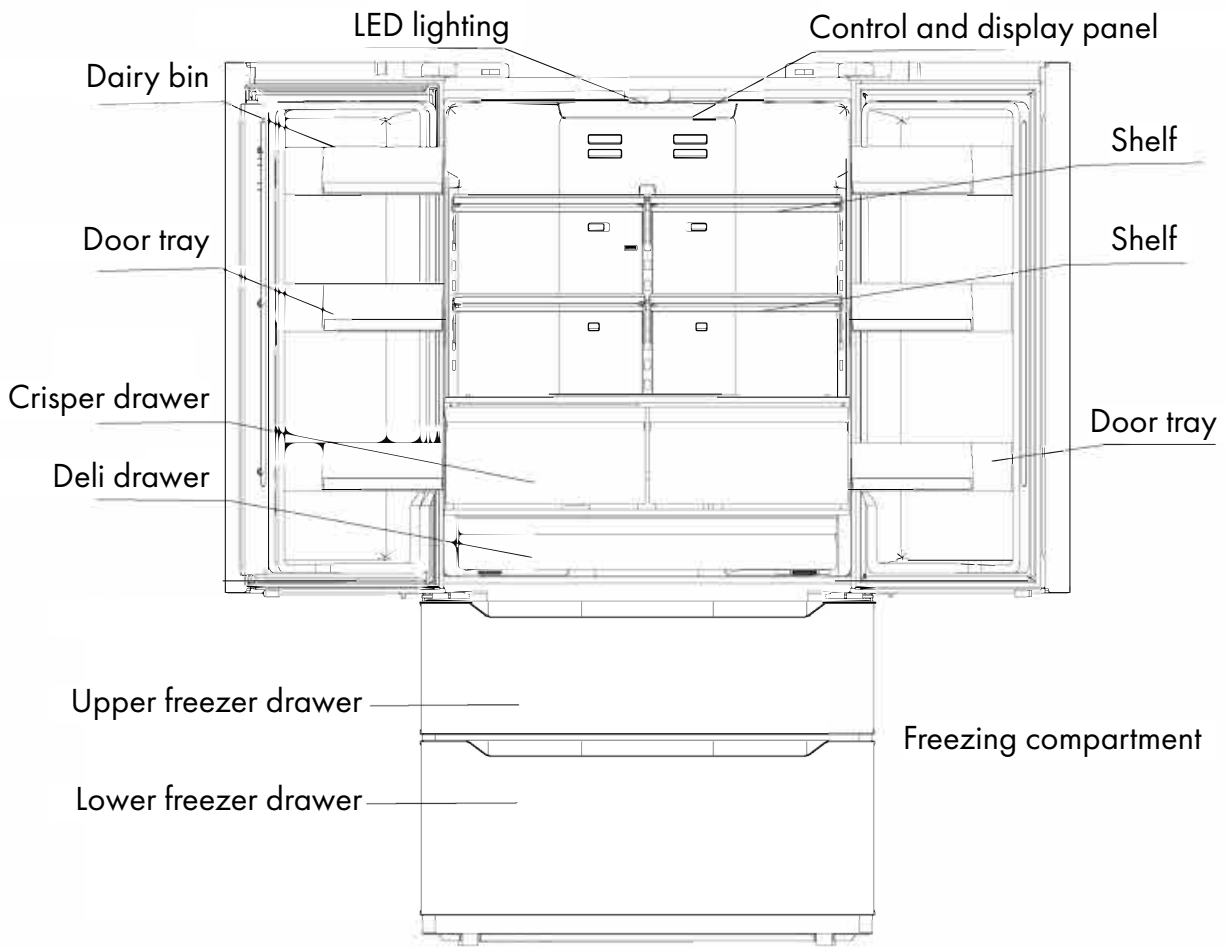

OPERATION

REFRIGERATING COMPARTMENT

- The refrigerating compartment is suitable for storage of a variety of fruits, vegetables, beverages, and other food consumed in the short term.
- Cooking ingredients should not be placed inside the refrigerating compartment until cooled to room temperature.
- Seal food items before putting into them into the refrigerator.
- The glass shelves are adjustable.

FREEZING COMPARTMENT

- The low temperature freezing compartment will keep food fresh for a long time and it is mainly used to store frozen food and make ice.
- The freezing compartment is suitable for storage of meat, fish, and other food not to be consumed in short term.
- It is recommended to divide chunks of meat into small pieces for easier freezing. Please note that food should be consumed within the shelf time.

NOTE: Storage of too much food during operation after initially connecting the unit to power may adversely impact the freezing effect of the appliance. Food stored should not block the air outlet, or the freezing effect will also be adversely impacted.

OPERATION

BUTTONS



1. Ice-making button
2. **SUPERCOOL** button
3. Temperature adjusting button of refrigerator compartment
4. Temperature adjusting button of freezer compartment
5. Super freeze button
6. Lock/unlock button

DISPLAY

- When the refrigerator is plugged in, the display screen will turn on and the start-up bell will ring. Then, the display screen enters the normal display of operation. Note that when powering the unit on for first time, the default set temperature of the refrigerator compartment and the freezer compartment is 41 °F / 0 °F.
- The display panel will always show the set temperature of both refrigerator and freezer compartments unless there is an error; then, an error code will display (see page 13).
- Under normal circumstances, the display light will go out after 30 seconds in a locked state; pressing a button on the control panel will wake up the display screen.
- If opening the door wakes up the display screen, the display light will go out immediately when the door is closed. When the "fault code visible" fault occurs, the display screen lights up and will go out after 30 seconds.

LOCK/UNLOCK

- To lock or unlock, press and hold the **Lock/Unlock** button until the buzzer sound rings.
- The refrigerator will enter the lock state if the door is not opened or if there is no button operation within 30 seconds.
- The door alarm can be stopped by pressing any one button in locked state, but any other button operations need to be performed in the unlocked state. If you try to operate the control panel while in the locked state, an error beep will sound.

OPERATION

SWITCHING BETWEEN FAHRENHEIT AND CELSIUS

Press and hold the **Lock/Unlock** button until it beeps. Once unlocked, hold the **FREEZER** and **FRIDGE** buttons until they beep. The temperature will then change from °C to °F or vice versa.

REFRIGERATOR TEMPERATURE SETTING

Press the temperature adjusting button of the refrigerator compartment to change the set temperature of refrigerator compartment. Each time the button is pressed, the temperature will drop 1 °F; the range is 34 °F to 44 °F. When the temperature reaches 34 °F and you press the button again, the set temperature will switch to 44 °F. The temperature setting will take effect after the display panel is locked.

FREEZER TEMPERATURE SETTING

Press the temperature adjusting button of the freezer compartment to change the set temperature. With each button press, the temperature will drop 1 °F; the range is -7 °F to 7 °F. When the temperature reaches -7 °F and you press the button again, the temperature will switch to 7 °F. The temperature setting will take effect after the display panel is locked.

MODE SETTINGS

- Press the **SUPERCOOL** button to start the super cool function. The refrigerator compartment is set to 34 °F automatically and the **SUPERCOOL** icon will be illuminated. When exiting super freeze mode, the temperature of refrigerator compartment will revert to the set temperature before **SUPERCOOL** mode was engaged.
- Press the **SUPERFRZ** button to start the super freeze function. The freezer compartment is set to -7 °F automatically and the **SUPERFRZ** icon will be illuminated. When exiting the super freeze mode, the temperature of freezer compartment will revert to the set temperature before **SUPERFRZ** mode was engaged.
- Press the **ICEMAKER** button and the ice-making function will be switched between on/off. When the  icon is on, it indicates the ice-making function is activated.

OPERATION

ICE MAKER

- The ice maker is located in the upper freezer above the ice storage bin. The ice maker stores up to 1.75 pounds of ice and can make up to 4.85 pounds daily. It takes up to 12 hours to produce ice when the appliance is plugged in for the first time.
- To turn on the ice maker, press and hold the ice maker button until ice maker icon appears.
- Repeat the process to turn the ice maker off.

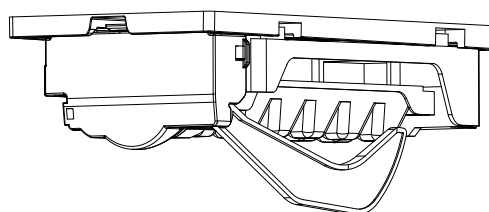
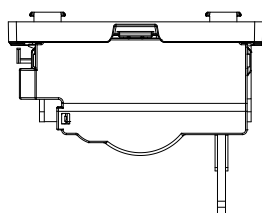

MAINTENANCE AND CLEANING

GENERAL CLEANING INSTRUCTIONS

- Dirt and dust behind the refrigerator and on the surrounding floor should be cleaned frequently to improve the cooling effect and to save energy.
- Check the door gasket regularly to make sure there is no debris. Clean the door gasket with a soft cloth dampened with soapy water or diluted detergent.
- The interior of the refrigerator should be cleaned regularly to avoid odor.
- Use a soft cloth or sponge to clean the inside of the refrigerator and mix 2 tablespoons of baking soda with a quart of warm water before wiping clean. After cleaning, open the door and let the appliance dry naturally before turning on the power.
- For areas that are difficult to clean in the refrigerator (such as narrow crevices, gaps, or corners), it is recommended to wipe them regularly with a soft rag, soft brush, etc., and when necessary, use non-metal or abrasive tools (such as Popsicle sticks) to ensure no contaminants or bacteria accumulates in these areas.
- Do not use detergent, scrub powder, spray cleaner, etc., as these may cause odors in the interior of the refrigerator or contaminate food.
- Clean the shelves and drawers with a soft cloth dampened with soapy water or a diluted kitchen-safe cleaner. Dry with a soft cloth or dry naturally.
- Wipe the outer surface of the refrigerator with a soft cloth dampened with a stainless steel cleaner, soapy water, detergent, etc., and then wipe dry.
- Do not use hard brushes, steel cleaning balls, wire brushes, abrasives (such as toothpastes), organic solvents (such as alcohol, acetone, banana oil, etc.), boiling water, or acid or alkaline items, as they all may damage the refrigerator surface and interior. Please note that boiling water and organic solvents such as benzene may deform or damage plastic parts.
- Do not spray water or other liquids directly into or on the refrigerator during cleaning to avoid short circuits or affect electrical insulation after immersion.

MAINTENANCE AND CLEANING

DOOR TRAY REMOVAL

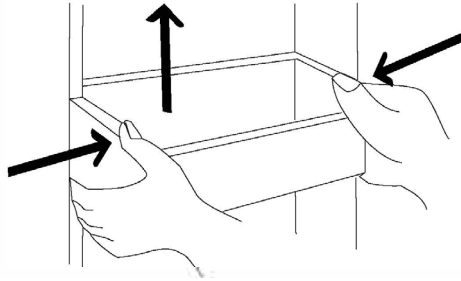

Following the direction of the arrow in the figure above, use both hands to squeeze the tray and push it upward, and then take it out to clean. Replace following the reverse of the steps above.

SHELVES

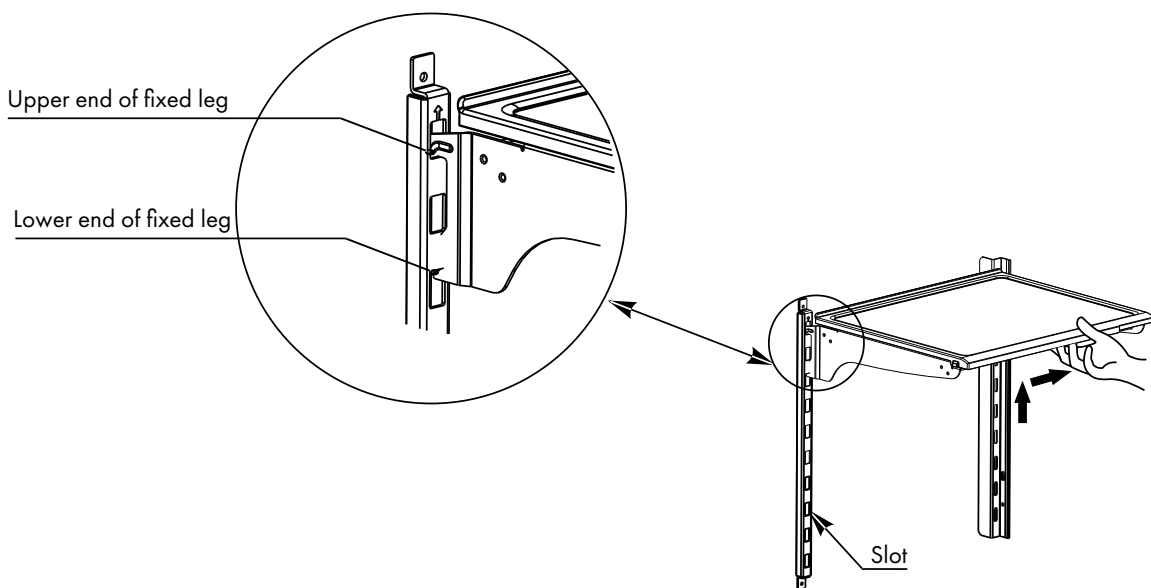

Adjust the shelves by following the arrows as shown in the diagram above:

1. Raise it upward first and then take it out by tilting it upward.
2. Lift the whole shelf until it cannot rise anymore.
3. Take out the shelf horizontally.

When replacing the shelves, put the upper end of the fixed leg into one of the upper slots on the shelf support bracket first and then put the lower end of the fixed leg into the slot below the top leg.

MAINTENANCE AND CLEANING

CHANGING THE LIGHT

Any replacement or maintenance of the LED lamps is intended to be made by a professional. If lights fail within the unit's warranty timeframe, call ZLINE Customer Service at 1-614-777-5004.

DEFROSTING

The refrigerator is made based on air-cooling principles and has an automatic defrosting function. Frost formed due to seasonal or temperature changes may be manually removed by disconnecting the appliance from power or by wiping with a dry towel.

OUT OF OPERATION

- **Power failure:** In case of power failure, even if it is in summer, food inside the appliance can be kept for several hours. During the power failure, decrease the amount of times the refrigerator doors are opened. Do not add more fresh food into the appliance.
- **Long-time non-use:** Unplug and clean the appliance. Leave the doors open to prevent odor.
- **Moving:** Before the refrigerator is moved, take all objects inside the compartment out, fix the glass partitions, vegetable/fruit crisper, freezing compartment drawers, etc. with tape and tighten the leveling feet. Close the doors and fix them with tape. During moving, the appliance should not be laid upside down or horizontally or be vibrated. The inclination during movement shall be no more than 45°.
- The appliance should run continuously once it is started. Generally, the operation of the appliance shall not be interrupted. Otherwise, the lifespan may be impaired.

TROUBLESHOOTING

ZLINE Customer Service is available at 1-614-777-5004.

ERROR CODES

When the following codes appear on the display screen, it indicates a problem with the refrigerator. Although the refrigerator in the following error cases will typically still provide standard cool/freeze functions, please call ZLINE Customer Service at 1-614-777-5004 to ensure normal use of refrigerator.

ERROR CODE	ERROR DESCRIPTION
E1	Temperature sensor failure of refrigerator compartment
E2	Temperature sensor failure of freezer compartment
E4	Defrost sensor error of refrigerator compartment
E5	Defrost sensor error of freezer compartment
E6	Communication error
E7	Ambient temperature sensor error
EH	Humidity sensor error
E0	Ice maker error

TROUBLESHOOTING

POSSIBLE FAULT	POSSIBLE CAUSE/SOLUTION
Failed operation	Check whether the appliance is connected to power and/or whether the plug is securely plugged in.
	Check whether the voltage is too low.
	Check whether there is a power failure or partial circuits have tripped.
Light doesn't turn on	Check whether the refrigerator is connected to power supply and/or whether the light is damaged.
Odor coming from the unit	Odorous food should be tightly wrapped.
	Check whether there is any spoiled food.
	Clean the inside of the refrigerator.
Refrigerator is running for a long time	Long operation of the refrigerator is normal in summer when the ambient temperature is high.
	Do not put too much food in the appliance at the same time.
	Food should be cooled before being put into the appliance.
	The doors are opened too frequently.
	The condenser may be dirty and should be cleaned with care.
Operating noises	Check whether the refrigerator and its components (ex: shelves and handles) are firmly in place.
	Buzz: The compressor may produce buzzes during operation and the buzzes are loud particularly upon start or stop. This is normal.
	Creak: Refrigerant flowing inside of the appliance may produce a creak, which is normal.
Doors cannot be properly closed	The door is obstructed by food packages.
	The refrigerator is tilted. Tighten the legs and make sure the unit is perfectly level.

TROUBLESHOOTING

POSSIBLE FAULT	POSSIBLE CAUSE/SOLUTION
Door seal is not tight	Remove foreign matters on the door seal.
	Heat the door seal and then cool it for restoration (or blow it with an electrical drier or use a hot towel for heating).
Water pan overflows	There is too much food in the compartment or food stored contains too much water, resulting in heavy defrosting.
	The doors are not closed properly, resulting in frosting due to the entry of air and increased water due to defrosting.
Hot housing	This is heat dissipation of the built-in condenser via the housing, which is normal. When housing becomes hot due to high ambient temperature and storage of too much food, it is recommended to provide sound ventilation to facilitate heat dissipation. Hot housing can also be caused by the refrigerator cooling frequently. This will be normal when hosting parties or when the door is left open for long periods of time.
Surface condensation	Condensation on the exterior surface and door seals of the refrigerator is normal when the ambient humidity is too high. Wipe the condensation with a clean towel.

WARRANTY

COVERAGE

ZLINE Kitchen and Bath ("ZLINE") counter-depth refrigerators have a one year parts and service warranty and a five year parts warranty on the unit's sealed cooling system.

ZLINE warranty periods begin from the original date of product delivery and solely cover the original purchaser of the product, delivered new and in its original carton. The limited warranty covers all parts and labor for necessary repairs if any part of the product, or the product itself, proves to be defective in materials or workmanship.

The product must be deemed serviceable via troubleshooting with the ZLINE Customer Experience team. All service on ZLINE products under warranty must be performed by ZLINE-approved and ZLINE-certified service providers unless otherwise specified by ZLINE. Service will be provided during normal business hours.

Products must be unobstructed and accessible to the service provider at the time of service. ZLINE's liability is limited to the original purchase price of the product. Additional injuries, losses, damages, or other inconveniences caused by product malfunction or defects in materials are not covered under the terms of this warranty.

TERMS

ZLINE warranties apply only to the original purchaser of a ZLINE product installed for normal residential use. This is defined as a single-family, residential dwelling in a non-commercial setting. Any warranty claim stemming from installation, operation, or any other use within a commercial setting is not covered under this limited warranty. Commercial settings include, but are not limited to: schools, churches, hotels, restaurants, vacation rentals such as Airbnb, daycare centers, private clubs, fire stations, common areas in multi-family dwellings, nursing homes, food service locations, and institutional food service locations such as hospitals or correctional facilities.

This warranty is non-transferable and will not under any circumstance be extended based on the date of installation — the warranty period takes effect from the date of delivery and only covers the original purchaser. The warranty applies only to products installed in the contiguous United States and the District of Columbia.

WARRANTY

Failure to secure certified warranty service per these terms will result in a forfeiture of the remaining warranty. Out-of-pocket payments will not be reimbursed unless prior approval is received from ZLINE and/or ZLINE-certified service contract partners. Unapproved out-of-pocket payments for service will not be reimbursed. All warranty procedures must be followed to maintain warranty coverage.

If a product qualifies within the service window provided under these warranty terms, and ZLINE is unable to repair the product or a defective part of the product after a reasonable number of attempts, ZLINE reserves the right to offer to replace the defective part or the product or provide the original purchaser a full refund of the purchase price of the product (not including installation, removal, or other charges that were not included in the original purchase price).

The original purchaser of the product must provide the original proof of purchase, including the purchase date, when filing a claim to obtain replacement parts, service, or refunds. Additionally, the original purchaser of the product must provide the serial number of the product when filing a claim to obtain replacement parts, service, or refunds.

This warranty shall not apply to any ZLINE product in which the original factory serial number has been removed, altered, or cannot be readily determined for any reason. Further, ZLINE is not responsible for damage resulting from, but not limited to: shipment, delivery, or improper installation; negligence or improper maintenance, misuse, or abuse of the product; unauthorized alteration, modification, or tampering with the product; accident, fire, floods, pest infestations, pandemics, natural disasters, or any other unpreventable or unexplained acts of nature, commonly referred to as "acts of God"; flare-up fires or damages caused by improper electric supply, electrical line current, voltage, or power surges; and service to correct installation not in accordance with the instructions contained in ZLINE's product manuals and/or with local government codes.

In the event service is dispatched, and it is discovered that the reported issue is not covered under warranty based on the disclaimers above, the customer will be responsible for all service fees. Failure to pay these fees will result in the forfeiture of remaining warranty coverage.

WARRANTY

Information contained within ZLINE's installation and user manuals, in addition to product information included on ZLINE's website and all related digital listings, do not cover every possible condition and situation that may occur during the installation or operation of ZLINE products.

ZLINE reserves the right to make changes at any time to its products when considered safe, necessary, and useful. Always check the ZLINE website for the most up-to-date version of its product manuals: www.zlinekitchen.com/pages/manuals.

Do not install or operate any ZLINE product if it has missing or broken parts or if it arrives damaged due to shipping. If ZLINE products arrive damaged, contact ZLINE Customer Experience at 1-614-777-5004 for help. Failure to report a damaged appliance prior to installation or operation may void the warranty.

ZLINE disclaims responsibility for damage or injury caused by improper installation or use of any of its products. ZLINE is under no obligation, by law or otherwise, to provide concessions, including repairs, prorates, rebates, discounts, or replacements, once the warranty has expired.

SERIAL NUMBER LOCATION



The rating tag shows the model and serial number of your refrigerator. The product label and rating tag is located inside the unit on the left-hand side, above the crisper drawer compartment. The tag is visible when the refrigerator door is open. Do not remove permanently affixed labels, warnings, or plates from the product. This will void the warranty.



WARRANTY



SERVICE

For warranty service, please contact our Customer Service team at 1-614-777-5004 or visit www.zlinekitchen.com/contact to utilize our online Customer Experience Portal.



Scan the QR code to view the most up-to-date version of our Installation Manual and User Manual.



Need to purchase a part or accessory for your ZLINE product?
Visit www.zlineparts.com, ZLINE's official parts distribution partner.

2.3.0

zlinekitchen.com

1-614-777-5004

contact@zlinekitchen.com

ZLINE
ATTAINABLE LUXURY®