

RS900FR6D

90 cm, FRIDGE, OFR Model

BUILT-IN

DESIGNER® SERIE

Fhiaba



FEATURES

- Made in Italy
- OptiView™: OptiView LED lights
- EventLift™: Easily rearrange the shelving without removal using the EvenLift system
- ProVent™: Uniform air circulation maintains consistent temperatures throughout the appliance resulting in better food preservation
- Anti-bacterial Stainless Steel Interiors Drawers: Achieve the highest food quality by storing food in the stainless steel interiors & drawers that shields against the spread of bacteria
- Total No Frost: Temperature control helping mitigate cooling loss when opening the refrigerator door. No more frost build-up that requires defrosting
- EquiLance™: Achieve a seamless built-in look with Fhiaba's innovative door hinge
- Soft - Close System: State-of-the-art closing system ensures refrigerator crisper drawers close smoothly and quietly

GENERAL PROPERTIES

Equilance Hinge	YES
Soft-Closing Glides	YES
Low Vibration	YES
OptiView (Led Light Spots)	YES
Shelves	3
Type Of Shelves	glass
Door Bins	3
Fridge Interior Drawers	3
Freezer Drawers	/
Evenlift Shelves	YES
Full Extension Shelves 90° Door Opening	NO
Full Extension Drawers 90° Door Opening	YES
Defrost Process	AUTOMATIC
Ice Maker With Water Filter	NO
Door Open Alarms	YES
Shopping Fridge	YES
Shopping Freezer	NO
Power Failure Alert	YES
Water Dispenser With Water Filter	YES

RS900FR6D

90 cm, FRIDGE, OFR Model

BUILT-IN

DESIGNER® SERIE

PRODUCT DETAIL

Fhiaba

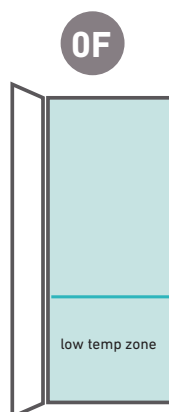
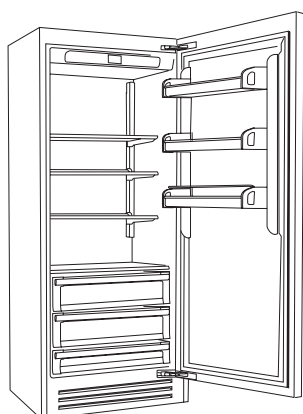

1D | 1M

fridge

D = door

M = separate microclimates

CAPACITY	
Volume Compartment 1 (L)	619
Volume Compartment 2 (L)	/
Volume Compartment 3 (L)	/
Total Net Volume (L)	619
Total Gross Volume (L)	629
Compartment 1 / Upper wine cellar capacity (bottles)	/
Compartment 2 / Lower wine cellar capacity (bottles)	/
Compartment 3 / Bottom wine cellar capacity (bottles)	/

DIMENSIONS & WEIGHT	
Height of the product (closed weels) (mm)	2120
Adjustable feet height (mm)	25
Width of the product (mm)	912
Depth of Product without handle (mm)	620
Wall cavity height (mm)	2134
Wall cavity width (mm)	914
Wall cavity depth (mm)	630
Net Weight (kg)	189
Gross Weight (kg)	210

TECHNICAL DETAILS	
Total absorbed current (A)	1.5
Voltage (V)	220-240V
Frequency (Hz)	50/60 Hz
Power Cord Length (mm)	2
Plug Type	Tipo F (Schuko) 16A IEC13 10A
Climatic class	SN/T
Noise level (dB)	41
Refrigerant (gas)	R600a
Water connection / female attachment	female 3/4"

TEMPERATURE RANGES	
Climatic compartments	1
Compartment 1 / Upper temperature (°C)	from 2 to 8
Compartment 2 / Middle temperature (°C)	
Low temp zone	YES
Compartment 3 / Low temperature (°C)	
Dual zone	NO

ACCESSORIES	
<ul style="list-style-type: none">• Stainless steel sides panels• Joining kit• Stainless steel portal for freestanding• Extra length anti-tipping kit• Anti-condensation• Water dispenser• Cleaning kit• FLD - Fhiaba Link Device• Front ventilation kit• Painting• 90° Door stop	

EFFICIENCY	
New Energy Label class	E
Energy consumption (kWh/year)	149

RS900FR6D

90 cm, FRIDGE, OFR Model

BUILT-IN

DESIGNER® SERIE

PRODUCT SPECIFICATIONS AND DIMENSIONS

Fhiaba

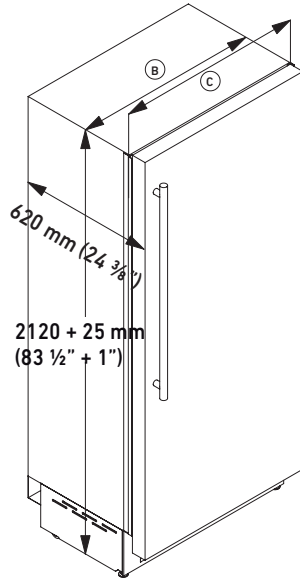
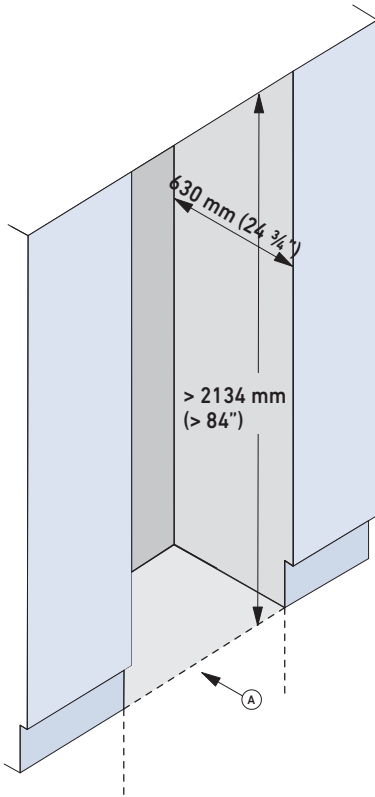

FRONT VIEW

SIDE VIEW

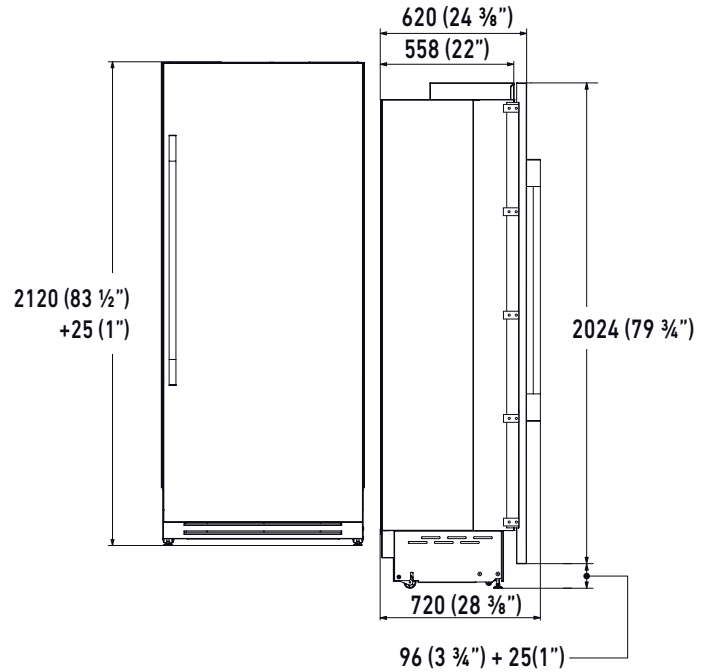

TECHNICAL DATA	
Niche Width A (mm)	914
Unit Width B (mm)	885
Unit Width with lateral frames C (mm)	912

TOP VIEW,
HINGE 105°

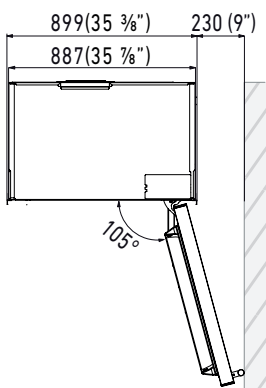

TOP VIEW,
HINGE 90°

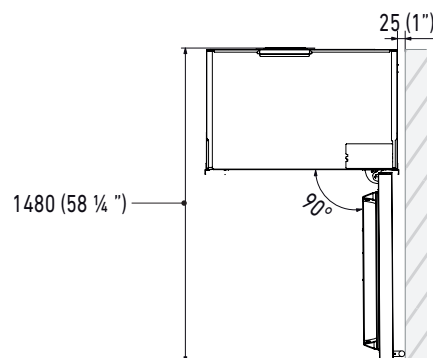

PLINTH SIZE

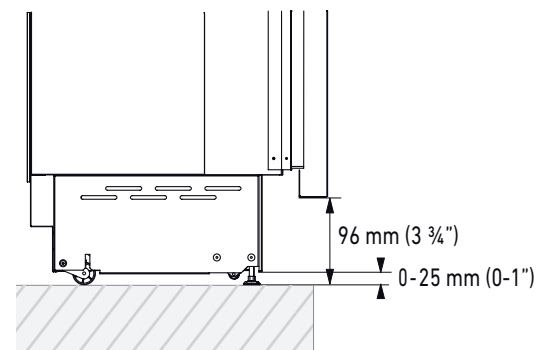

i For installation specifications, please consult with Fhiaba. For optimum installation, we recommend using the actual product as the best guide.

i Based on the adjustment of the feet and the height of the panel from the floor, the customer defines the perforated plinth to be installed on the equipment.

RS900FR6D

90 cm, FRIDGE, OFR Model

BUILT-IN

DESIGNER® SERIE

PRODUCT SPECIFICATIONS

Fhiaba

Electrical Connection



Electrical and water connections (if applicable) should be reachable without having to uninstall the appliance. If the connections must be made directly behind the appliance then it is recommended to recess those connections.

IMPORTANT: do not put the water shut-off valve behind the appliance where it will be inaccessible.



For installation specifications, please consult with Fhiaba. For optimum installation, we recommend using the actual product as the best guide.



www.fhiaba.com