

RS901TWT3

90 cm, DUAL COMPARTMENT WINE CELLAR, 1T Model

BUILT-IN

DESIGNER® SERIE

Fhiaba



FEATURES

- Made in Italy
- TriMode™: Total Flexibility, make the bottom drawer a refrigerator, fresh food space, or freezer with the control menu
- ProVent™: Uniform air circulation maintains consistent temperatures throughout the appliance resulting in better food preservation
- OptiView™: OptiView LED lights
- ProVent™: Uniform air circulation maintains consistent temperatures throughout the appliance resulting in better food preservation
- Humidity Control: Choose between high, medium and low humidity – particularly important for wine storage
- Total No Frost: Temperature control helping mitigate cooling loss when opening the refrigerator door. No more frost build-up that requires defrosting
- EquiLance™: Achieve a seamless built-in look with Fhiaba's innovative door hinge

GENERAL PROPERTIES

Equilance Hinge	YES
Soft-Closing Glides	YES
Low Vibration	YES
OptiView (Led Light Spots)	YES
Shelves	4
Type Of Shelves	WOOD
Door Bins	/
Fridge Interior Drawers	/
Freezer Drawers	1
Evenlift Shelves	NO
Full Extension Shelves 90° Door Opening	YES
Full Extension Drawers 90° Door Opening	NO
Defrost Process	AUTOMATIC
Ice Maker With Water Filter	NO
Door Open Alarms	YES
Shopping Fridge	NO
Shopping Freezer	NO
Power Failure Alert	YES
Water Dispenser With Water Filter	NO

RS901TWT3

90 cm, DUAL COMPARTMENT WINE CELLAR, 1T Model

BUILT-IN

DESIGNER® SERIE

PRODUCT DETAIL

Fhiaba

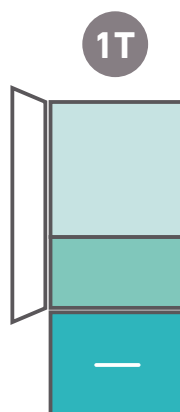
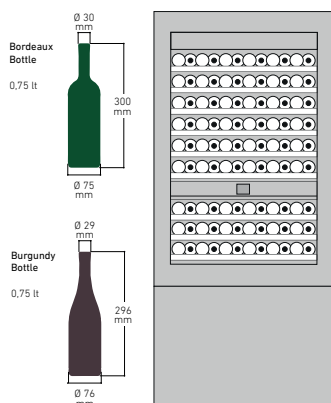
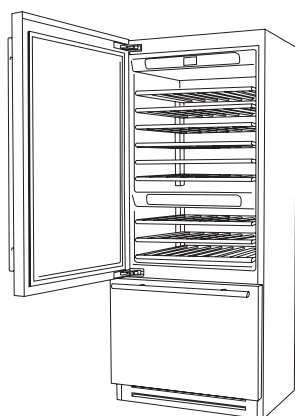

1D | 1BD | 3M

D = door
BD = drawer
M = separate microclimates

CAPACITY

Volume Compartment 1 (L)	247
Volume Compartment 2 (L)	128
Volume Compartment 3 (L)	131
Total Net Volume (L)	506
Total Gross Volume (L)	525
Compartment 1 / Upper wine cellar capacity (bottles)	72
Compartment 2 / Lower wine cellar capacity (bottles)	36
Compartment 3 / Bottom wine cellar capacity (bottles)	

TECHNICAL DETAILS

Total absorbed current (A)	2
Voltage (V)	220-240V
Frequency (Hz)	50/60 Hz
Power Cord Length (mm)	2
Plug Type	Tipo F (Schuko) 16A IEC13 10A
Climatic class	SN/T
Noise level (dB)	41
Refrigerant (gas)	R600a
Water connection / female attachment	/

EFFICIENCY

New Energy Label class	G
Energy consumption (kWh/year)	194

DIMENSIONS & WEIGHT

Height of the product (closed weels) (mm)	2120
Adjustable feet height (mm)	25
Width of the product (mm)	912
Depth of Product without handle (mm)	620
Wall cavity height (mm)	2134
Wall cavity width (mm)	914
Wall cavity depth (mm)	630
Net Weight (kg)	205
Gross Weight (kg)	226

TEMPERATURE RANGES

Climatic compartments	3
Compartment 1 / Upper temperature (°C)	from 4 to 18
Compartment 2 / Middle temperature (°C)	from 4 to 18
Low temp zone	NO
Compartment 3 / Low temperature (°C)	from 4 to 18
Dual zone	NO

ACCESSORIES

- Stainless steel sides panels
- Glass door
- Joining kit
- Stainless steel portal for freestanding
- Extra length anti-tipping kit
- Anti-condensation
- Cleaning kit
- Active carbon filter
- FLD - Fhiaba Link Device
- Front ventilation kit
- Painting
- 90° Door stop
- Wine kit
- Cheese drawer
- Set of knives
- Bottle trap
- Sigar drawer
- Beverage drawer
- Beverage shelf
- Beverage removable shelf

RS901TWT3

90 cm, DUAL COMPARTMENT WINE CELLAR, 1T Model

BUILT-IN

DESIGNER® SERIE

PRODUCT SPECIFICATIONS AND DIMENSIONS

Fhiaba

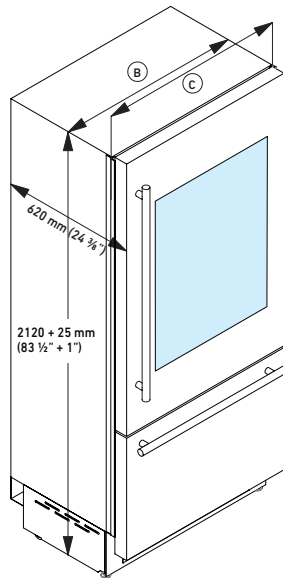
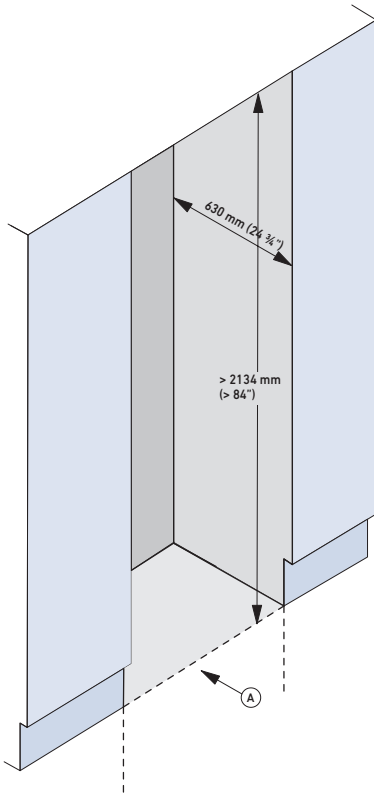

FRONT VIEW

SIDE VIEW

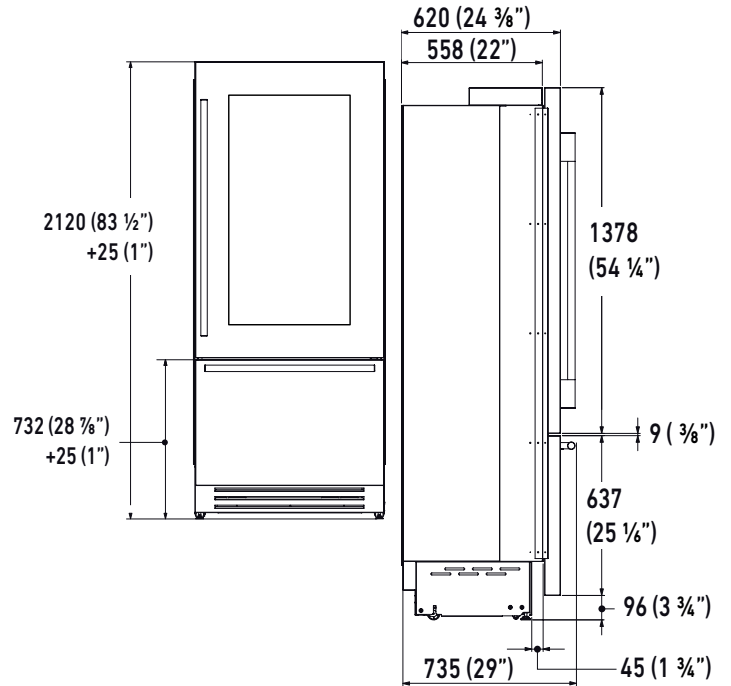

TECHNICAL DATA	
Niche Width A (mm)	914
Unit Width B (mm)	885
Unit Width with lateral frames C (mm)	912

TOP VIEW,
HINGE 105°

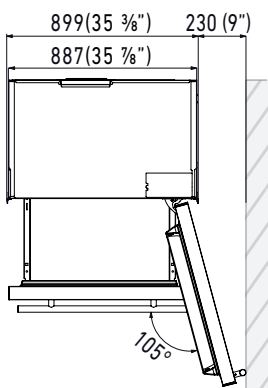

TOP VIEW,
HINGE 90°

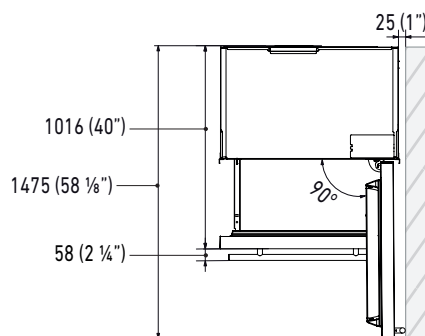

PLINTH SIZE

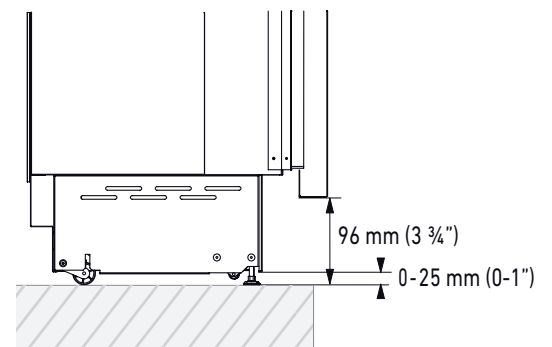

i For installation specifications, please consult with Fhiaba. For optimum installation, we recommend using the actual product as the best guide.

i Based on the adjustment of the feet and the height of the panel from the floor, the customer defines the perforated plinth to be installed on the equipment.

RS901TWT3

90 cm, DUAL COMPARTMENT WINE CELLAR, 1T Model

BUILT-IN

DESIGNER® SERIE

PRODUCT SPECIFICATIONS

Fhiaba

Electrical Connection



Electrical and water connections (if applicable) should be reachable without having to uninstall the appliance. If the connections must be made directly behind the appliance then it is recommended to recess those connections.

IMPORTANT: do not put the water shut-off valve behind the appliance where it will be inaccessible.



For installation specifications, please consult with Fhiaba. For optimum installation, we recommend using the actual product as the best guide.



www.fhiaba.com