

S600FR6

60 cm, FRIDGE, OFR Model

BUILT-IN

INTEGRATED® SERIE

Fhiaba



FEATURES

- Made in Italy
- OptiView™: OptiView LED lights
- EventLift™: Easily rearrange the shelving without removal using the EvenLift system
- ProVent™: Uniform air circulation maintains consistent temperatures throughout the appliance resulting in better food preservation
- Anti-bacterial Stainless Steel Interiors Drawers: Achieve the highest food quality by storing food in the stainless steel interiors & drawers that shields against the spread of bacteria
- Total No Frost: Temperature control helping mitigate cooling loss when opening the refrigerator door. No more frost build-up that requires defrosting
- EquiLance™: Achieve a seamless built-in look with Fhiaba's innovative door hinge
- Soft - Close System: State-of-the-art closing system ensures refrigerator crisper drawers close smoothly and quietly

GENERAL PROPERTIES

Equilance Hinge	YES
Soft-Closing Glides	YES
Low Vibration	YES
OptiView (Led Light Spots)	YES
Shelves	3
Type Of Shelves	glass
Door Bins	3
Fridge Interior Drawers	3
Freezer Drawers	
Evenlift Shelves	YES
Full Extension Shelves 90° Door Opening	NO
Full Extension Drawers 90° Door Opening	YES
Defrost Process	AUTOMATIC
Ice Maker With Water Filter	NO
Door Open Alarms	YES
Shopping Fridge	YES
Shopping Freezer	NO
Power Failure Alert	YES
Water Dispenser With Water Filter	NO

S600FR6

60 cm, FRIDGE, OFR Model

BUILT-IN

INTEGRATED® SERIE

PRODUCT DETAIL

Fhiaba

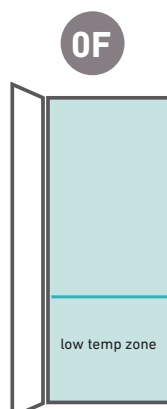
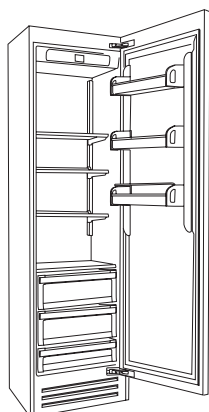

1D | 1M

fridge

D = door

M = separate microclimates

CAPACITY

Volume Compartment 1 (L)	368
Volume Compartment 2 (L)	/
Volume Compartment 3 (L)	/
Total Net Volume (L)	368
Total Gross Volume (L)	378
Compartment 1 / Upper wine cellar capacity (bottles)	/
Compartment 2 / Lower wine cellar capacity (bottles)	/
Compartment 3 / Bottom wine cellar capacity (bottles)	/

TECHNICAL DETAILS

Total absorbed current (A)	1.5
Voltage (V)	220-240V
Frequency (Hz)	50/60 Hz
Power Cord Length (mm)	2
Plug Type	Tipo F (Schuko) 16A IEC13 10A
Climatic class	SN/T
Noise level (dB)	41
Refrigerant (gas)	R600a
Water connection / female attachment	/

EFFICIENCY

New Energy Label class	E
Energy consumption (kWh/year)	118

DIMENSIONS & WEIGHT

Height of the product (closed weels) (mm)	2050
Adjustable feet height (mm)	25
Width of the product (mm)	599
Depth of Product without handle (mm)	610
Wall cavity height (mm)	2064
Wall cavity width (mm)	600
Wall cavity depth (mm)	650
Net Weight (kg)	132
Gross Weight (kg)	152

TEMPERATURE RANGES

Climatic compartments	1
Compartment 1 / Upper temperature (°C)	from 2 to 8
Compartment 2 / Middle temperature (°C)	
Low temp zone	YES
Compartment 3 / Low temperature (°C)	
Dual zone	NO

ACCESSORIES

- Stainless steel sides panels
- Front ventilation kit
- Joining kit
- 90° Door stop
- Stainless steel tubular handle Ø30mm
- Stainless steel tubular handle Ø18mm
- Stainless steel panels
- Stainless steel portal for freestanding
- Extra length anti-tipping kit
- Anti-condensation
- Cleaning kit
- FLD - Fhiaba Link Device

S600FR6

60 cm, FRIDGE, OFR Model

BUILT-IN

INTEGRATED® SERIE

PRODUCT SPECIFICATIONS AND DIMENSIONS

Fhiaba

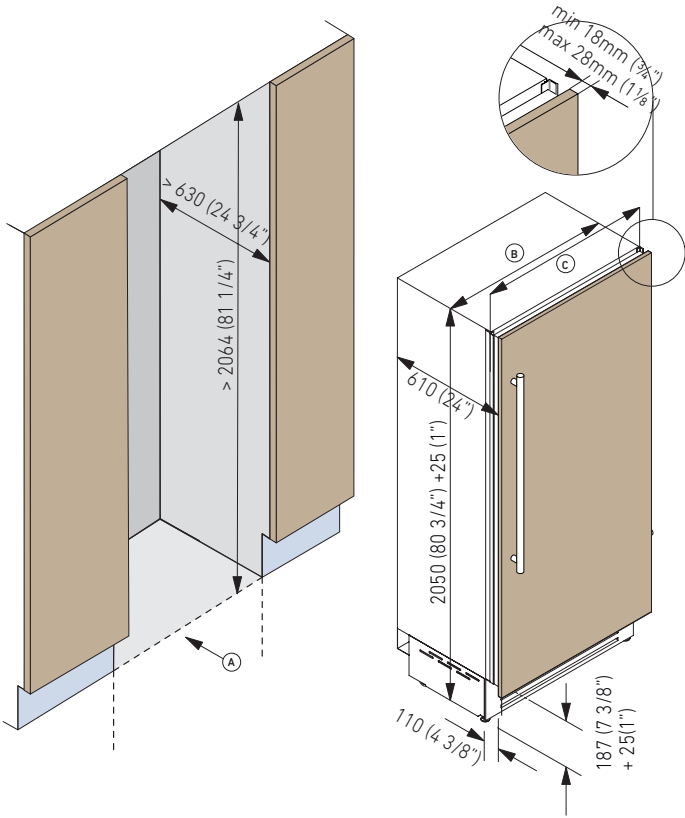

FRONT VIEW

SIDE VIEW

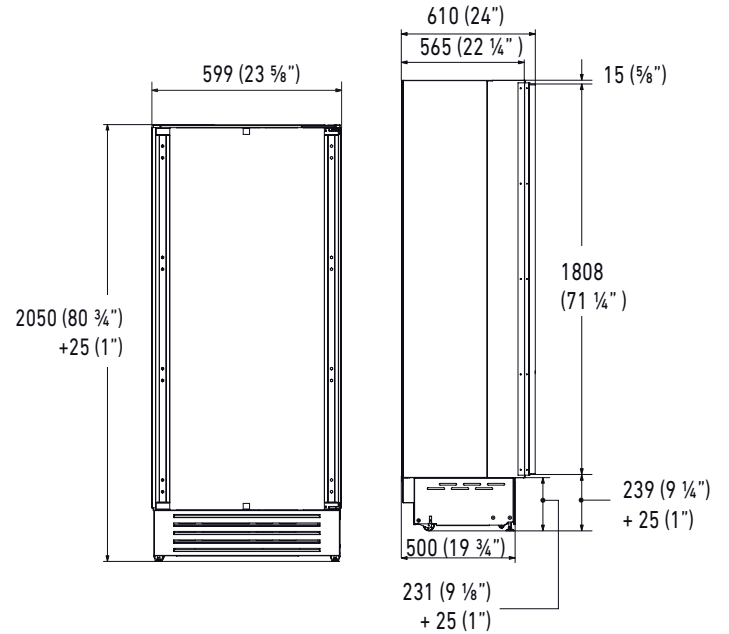

TECHNICAL DATA	
Niche Width A (mm)	600
Unit Width B (mm)	587
Unit Width with lateral frames C (mm)	599

TOP VIEW, HINGE 105°

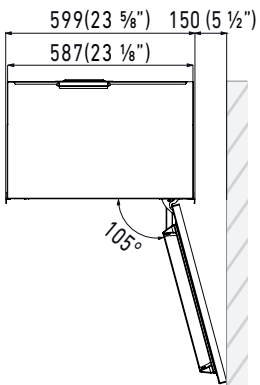

TOP VIEW, HINGE 90°

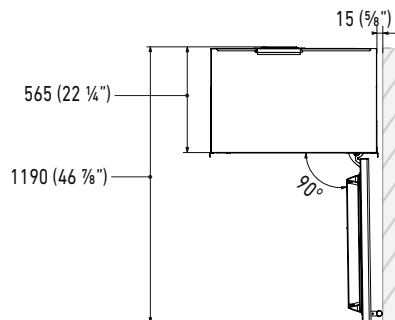

PLINTH SIZE

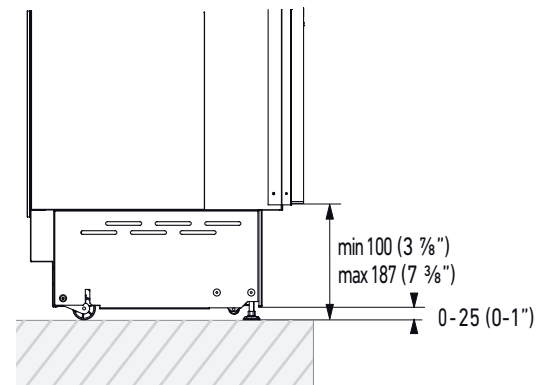

i For installation specifications, please consult with Fhiaba. For optimum installation, we recommend using the actual product as the best guide.

i Based on the adjustment of the feet and the height of the panel from the floor, the customer defines the perforated plinth to be installed on the equipment.

S600FR6

60 cm, FRIDGE, OFR Model

BUILT-IN

INTEGRATED® SERIE

CUSTOM PANELS INFORMATION

Fhiaba

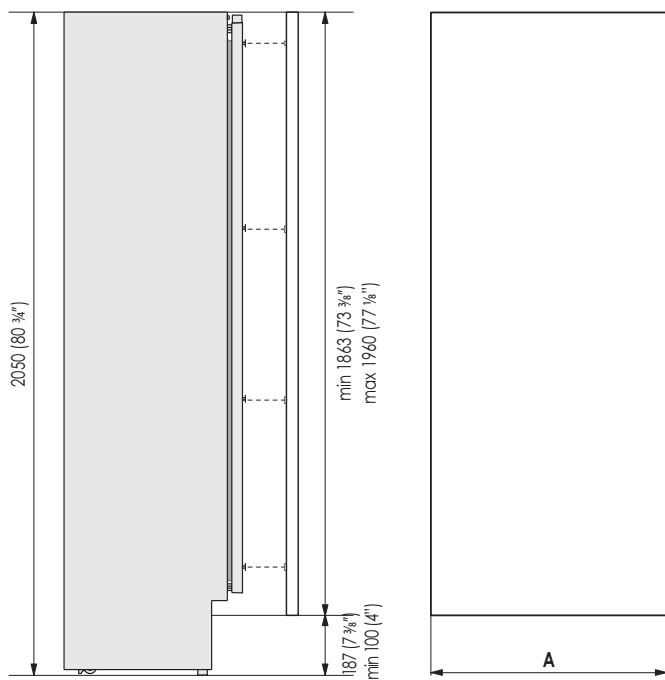

Serie	A
599 (60 cm)	597 (23 1/2")



INTEGRATED PANEL RECOMMENDATIONS

Panels with thickness ranging between 18 mm and 28 mm

Door Panels Weight Max	34 kg
Drawer Panels Weight Max	/ kg

 For installation specifications, please consult with Fhiaba.
For optimum installation, we recommend using the actual product as the best guide.

S600FR6

60 cm, FRIDGE, OFR Model

BUILT-IN

INTEGRATED® SERIE

PRODUCT SPECIFICATIONS

Fhiaba

Electrical Connection



Electrical and water connections (if applicable) should be reachable without having to uninstall the appliance. If the connections must be made directly behind the appliance then it is recommended to recess those connections.

IMPORTANT: do not put the water shut-off valve behind the appliance where it will be inaccessible.



For installation specifications, please consult with Fhiaba. For optimum installation, we recommend using the actual product as the best guide.



www.fhiaba.com