

# SFU4104VCS



Category	Compact 24"
Product family	Oven
Power supply	Electrical
Power supply	Electricity
Cooking method	Combi Steam
Cleaning system	VaporClean
EAN code	8017709268442



## Aesthetic

Aesthetics	Linea	Silkscreen type	Symbols
Color	Silver	Door	Full-glass
Design	Flat	Handle	Linea-design
Material	Glass	Handle color	Chromed
Glass type	Stopsol	Logo	Silkscreened
Silkscreen color	White		

## Controls

			
Display technology	TFT	No. of display languages	11
Controls setting	Full-touch	Display languages	Italiano, English (US), Français (CA), Español (MX), Português (PT), zh-CHS, zh-CHT

## Programs / Functions

No. of cooking functions	14
Automatic programmes	50
Customisable recipes	10

### Traditional cooking functions

- |                   |                    |                          |
|-------------------|--------------------|--------------------------|
| Static            | Fan-assisted       | True European convection |
| Turbo             | Eco                | Large grill              |
| Fan grill (large) | Circulaire + grill | Bottom                   |
| Convection bottom |                    |                          |

### Cooking functions with steam

- |                           |              |            |
|---------------------------|--------------|------------|
| Steam                     | Fan-assisted | Circulaire |
| Warming and re-generation |              |            |

### Other steam functions

- |                   |              |             |
|-------------------|--------------|-------------|
| Tank cleaning     | Water outlet | Water input |
| Descaling program |              |             |

### Other functions

- |                 |                   |       |
|-----------------|-------------------|-------|
| Defrost by time | Defrost by weight | Proof |
| Sabbath         |                   |       |

### Cleaning functions

- Vapor Clean

## Options



- |                             |  |                      |                      |
|-----------------------------|--|----------------------|----------------------|
| <b>Time-setting options</b> | Delayed start and automatic shut-off when cooking ends | <b>Other options</b> | Keep-warm, Eco light |
| <b>Minute minder</b>        | Yes  | <b>Showroom mode</b> | Yes                  |
| <b>Child safety lock</b>    | Yes  |                      |                      |

## Technical Features



- |                            |        |                              |                 |
|----------------------------|--------|------------------------------|-----------------|
| <b>Minimum Temperature</b> | 86 °F  | <b>Door</b>                  | Cool-touch door |
| <b>Maximum temperature</b> | 482 °F | <b>Removable door</b>        | Yes             |
| <b>No. of shelves</b>      | 3      | <b>Full-glass inner door</b> | Yes             |

<b>No. of lights</b>	1	<b>Removable inner door</b>	Yes
<b>Lighting</b>	Halogen	<b>Total no. of door glasses</b>	3
<b>Replaceable light</b>	Yes	<b>Soft Close</b>	Yes
<b>Light power</b>	40 W	<b>Cooling system</b>	Tangential
<b>Light on when door is open</b>	Yes	<b>Cooling duct</b>	Single
<b>Lower heating element power</b>	1000 W	<b>Temperature control</b>	Electronic
<b>Grill element - power</b>	2000 W	<b>Cavity material</b>	EverClean enamel
<b>Circular heating element - Power</b>	1400 W	<b>Water loading</b>	Automatic Fill&Hide
<b>Heating elements stop when door is opened</b>	Yes	<b>Tank capacity</b>	40.5 oz
<b>Boiler - Power</b>	900 W	<b>Steam off when door is opened</b>	Yes
<b>Door opening</b>	Standard opening		

## Performance / Energy Label



**Volume of the cavity** 1.41 cu. ft.

## Accessories Included



<b>Rack with back stop</b>	1	<b>Stainless steel mesh tray (1.6" deep)</b>	1
<b>Enameled 1.6"-deep tray</b>	1	<b>Telescopic Guide rails, total Extraction</b>	1
<b>Insert grid</b>	1	<b>Other</b>	Sponge/ Boiler cover/ Carafe
<b>Stainless steel tray (0.8" deep)</b>	1		

## Electrical Connection

<b>Voltage</b>	230 V	<b>Current</b>	13 A
<b>Nominal power</b>	3400 W	<b>Frequency</b>	60 Hz
<b>Voltage</b>	120/208 V	<b>Power cord length</b>	45 1/4 "

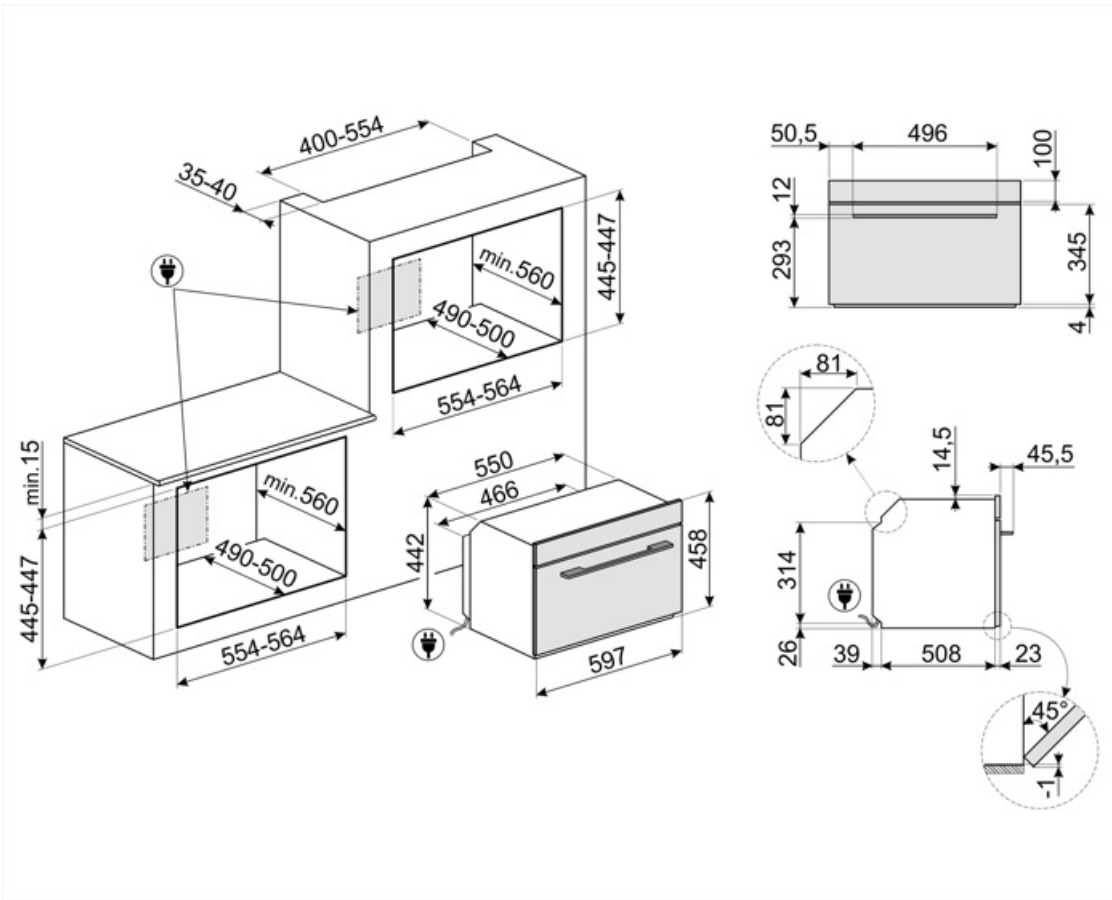

---

## Not included accessories

---

### BN620-1

Enamelled tray, 20mm deep



### PALPZ

Pizza shovel with fold away handle  
width: 315mm length : 325mm



### PRTX

Refractory pizza stone with handles.  
D=35cm Not suitable for microwave  
ovens. Suitable for gas ovens, to be put  
on the griddle.



### BN640

Enamelled tray, 40mm deep











































### PR3845X

Antifingerprint stainless steel. Cover  
for furniture in column installation of  
more ovens



## Symbols glossary (TT)

 <p>Child lock: some models are fitted with a device to lock the programme/cycle so it cannot be accidentally changed.</p>	 <p>Combination steam: ovens can be used either as a steam oven, or as a traditional oven, or alternatively the two methods can be combined.</p>
 <p>Air cooling system: to ensure a safe surface temperatures.</p>	 <p>Defrost by time: with this function the time of thawing of foods are determined automatically.</p>
 <p>Defrost by weight: With this function the defrosting time is determined</p>	 <p>Descaling function: Is essential to remove excess deposits of limestone in the tank and allow the proper operation of the product. The need to perform this operation is signaled by the product itself.</p>
 <p>Triple glazed doors: Number of glazed doors.</p>	 <p>Automatic lighting switches off: for greater energy savings, the lighting switches off automatically after one minute from the start of cooking.</p>
 <p>Electric</p>	 <p>Enamel interior: The enamel interior of all Smeg ovens have a special antacid lining which helps keep the interior clean by reducing the amount of cooking grease adhering to it.</p>
 <p>Circogas: In gas ovens the fan distributes the heat quickly and evenly throughout the oven cavity, avoiding flavour transfer when cooking a number of different dishes at the same time. In electric ovens this combination completes cooking more quickly of foods that are ready on the surface, but that require more cooking inside, without further browning.</p>	 <p>Fan with upper and lower elements: The elements combined with the fan aim to provide more uniform heat, a similar method to conventional cooking, so pre-heat is required. Most suitable for items requiring slow cooking methods.</p>
 <p>Upper and lower element only: a traditional cooking method best suited for single items located in the centre of the oven. the top pf the oven will always be hottest. Ideal for roast, fruit cakes, bread etc.</p>	 <p>Lower heating element only: This function is ideal for foods that require extra base temperature without browning, e.g. pastry dishes, pizza. Also suitable for slow cooking of stews and casseroles.</p>
 <p>Circulaire + grill: Circulaire with upper element or grill: Similar to fan with upper element with the added cooking speed of circulaire, ideal for dishes with a crispy topping. When used with the grill the food will brown more quickly.</p>	 <p>True European Convection: The combination of the fan and circular heating element around it provides many benefits, including no preheat if cooking time is longer than 20 minutes, no flavor transfer when cooking different foods at the same time, lower energy consumption, and shorter cooking times. Suitable for all types of food preparations.</p>
 <p>ECO: The combination of the grill, fan and lower element is particularly suitable for cooking small quantities of food.</p>	 <p>Grill element: Using of grill gives excellent results when cooking meat of medium and small portions, especially when combined with a rotisserie (where possible). Also ideal for cooking sausages and bacon.</p>

- |  |  |
|--|--|
|  <p>Fan with grill element: The fan reduces the fierce heat from the grill, providing an excellent method of grilling various foods, chops, steaks, sausages etc. giving even browning and heat distribution, without drying out the food. The top two levels recommended for use, and the lower part of the oven can be used to keep items warm at the same time, an excellent facility when cooking a grilled breakfast. Half grill (centre portion only) is ideal for small quantities of food.</p> |  <p>Steam cooking: it's a natural way of cooking for any kind of products, from vegetables to desserts, to preserve the nutritional and organoleptic properties of ingredients. Ideal for cooking without fat, to heat up food without drying. Steam is ideal for simultaneous cooking of meals that require different cooking times.</p> |
|  <p>Fan combined with traditional cooking, where heat is generated from above and below, provides uniform heat. Adding the steam function allows the same cooking results in less time.</p>  |  <p>Circular element with steam: Cooking with the simultaneous use of the circular heating element in combination with fan and steam supply.</p>  |
|  <p>FUN_STEAM_OTHER_WATER_IN_OUT_72dpi</p>   |  <p>Reheat: This function can reheat precooked dishes, without becoming dry or hard.</p>  |
|  <p>Circular element with upper and lower elements: The use of the fan with both elements allows food to be cooked quickly and effectively, ideal for large joints that require thorough cooking. It offers a similar result to rotisserie, moving the heat around the food, instead of moving the food itself, enabling any size or shape to be cooked.</p>   |  <p>Compact appliances with a height of 45 cm - perfect solution to meet the functional requirements of kitchen sets of small height. Available in several types and in different styles.</p>   |
|  <p>All glass inner door: All glass inner door, a single flat surface which is simple to keep clean.</p>   |  <p>The inner door glass: can be removed with a few quick movements for cleaning.</p>   |
|  <p>KEEP_WARM_72dpi</p>  |  <p>Side lights: Two opposing side lights increase visibility inside the oven.</p>  |
|  <p>ECO-logic: option allows you to restrict the power limit of the appliance real energy saving.</p>  |  <p>Air at 40°C provides the perfect environment for proving yeast type dough mixes. Simply select the function and place dough in the cavity for allotted</p>  |
|  <p>Sabbath: This function allows you to cook food during the Sabbath, the Holiday of rest in the Jewish religion, respecting the precepts. The oven works</p>   |  <p>The oven cavity has 3 different cooking levels.</p>   |
|  <p>Soft close: all models are equipped with advanced function of smooth closing of the door, which allows the device to close smoothly and quietly.</p>   |  <p>To guarantee the optimal functioning of the appliance, it is suggested to carry out the tank cleaning roughly once every 2-3 months.</p>  |
|  <p>Telescopic rails: allow you to pull out the dish and check it without having to remove it from the oven entirely.</p>  |  <p>Electronic control: Allows you to maintain temperature inside the oven with the precision 2-3 ° C. This enables to cook meals that are very sensitive to temperature changes, such as cakes, souffles, puddings.</p>  |
|  <p>Touch controls: Easy to use touch controls allow the appliance to be programmed at the touch of a button.</p>  |  <p>Vapor Clean: a simple cleaning function using steam to loosen deposits in the oven cavity.</p>  |



---

The capacity indicates the amount of usable space in the oven cavity in litres.