

SFU6302TVX



Category	24"
Product family	Oven
Power supply	Electrical
Cooking method	Thermo-ventilated
Cleaning system	VaporClean



Aesthetic









Aesthetics	Classic	Stainless steel type	Brushed
Color	Stainless steel	Silkscreen color	Black
Finishing	Fingerprint-proof	Silkscreen type	Symbols
Design	Flat	Handle color	Stainless steel
Material	Stainless steel	Logo	Embossed

Controls

Display technology	LCD
--------------------	-----

Programs / Functions

No. of cooking functions	9
Automatic programmes	20
Traditional cooking functions	

 Static	 Fan-assisted	 True European convection
 Turbo	 Eco	 Large grill
 Fan grill (large)	 Bottom	 Convection bottom

Other functions



Defrost by time



Defrost by weight



Proof



Sabbath

Cleaning functions



Vapor Clean

Options



Time-setting options

Delayed start and automatic shut-off when cooking ends

Minute minder

Yes

Child safety lock

Yes

Other options

Showroom mode

Keep-warm, Eco light

Yes

Technical Features



Minimum Temperature	86 °F
Maximum temperature	536 °F
No. of shelves	5
Fan	Single
No. of lights	2
Lighting	Halogen
Replaceable light	Yes
Light power	40 W
Light on when door is open	Yes
Lower heating element power	1200 W
Upper heating element - Power	1000 W
Grill element - power	1700 W

Large grill - Power	2700 W
Circular heating element - Power	2000 W
Heating elements stop when door is opened	Yes
Door	Cool-touch door
Removable inner door	Yes
Total no. of door glasses	4
Soft Close	Yes
Cooling system	Tangential
Cooling duct	Single
Cooling System Speed Reduction	Yes
Cavity material	EverClean enamel

Performance / Energy Label



Volume of the cavity 2.54 cu. ft.

Accessories Included



Insert grid

1

Rack with back and side stop 1

Enameled 0.8"-deep tray 1

Enameled 1.6"-deep tray 1

Telescopic Guide rails, partial Extraction 1

Electrical Connection

Voltage 230 V
 Nominal power 3400 W
 Voltage 120/208 V

Current 13 A
 Frequency 60 Hz
 Power cord length 45 1/4 "

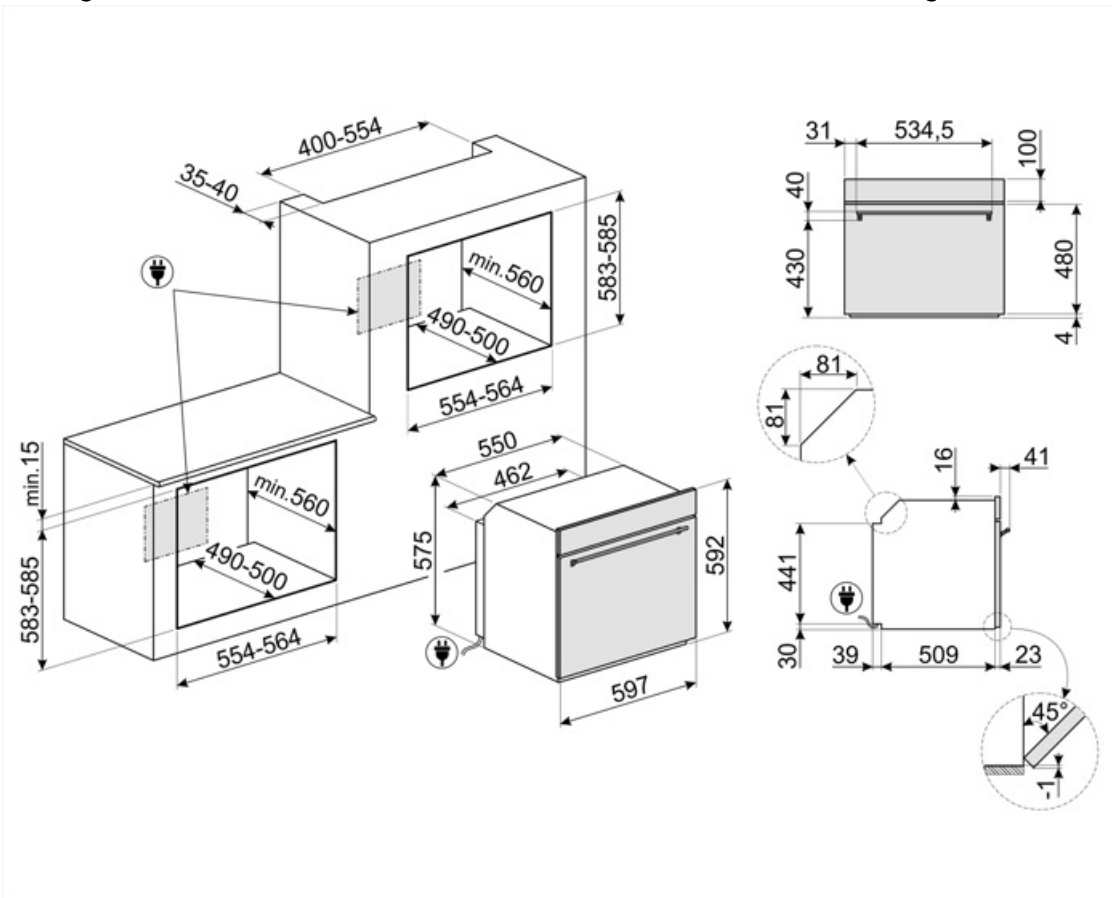

Not included accessories

BN620-1

Enamelled tray, 20mm deep



GTP

****Partial-extension telescopic guides****
Length: 14" Extraction: 11 1/4" Material:
Stainless steel AISI 430 polished



PALPZ

Pizza shovel with fold away handle
width: 315mm length : 325mm



PRTX

Refractory pizza stone with handles.
D=35cm Not suitable for microwave
ovens. Suitable for gas ovens, to be put
on the griddle.



BN640

Enamelled tray, 40mm deep



GTT

****Total-extension telescopic guides****
Length: 14" Extraction: 16.5" Material:
Stainless steel AISI 430 polished































PR3845X

Antifingerprint stainless steel. Cover
for furniture in column installation of
more ovens



Symbols glossary (TT)

 <p>Child lock: some models are fitted with a device to lock the programme/cycle so it cannot be accidentally changed.</p>	 <p>Air cooling system: to ensure a safe surface temperatures.</p>
 <p>Defrost by time: with this function the time of thawing of foods are determined automatically.</p>	 <p>Defrost by weight: With this function the defrosting time is determined</p>
 <p>Quadruple glazed: Number of glazed doors.</p>	 <p>Automatic lighting switches off: for greater energy savings, the lighting switches off automatically after one minute from the start of cooking.</p>
 <p>Electric</p>	 <p>Enamel interior: The enamel interior of all Smeg ovens have a special antacid lining which helps keep the interior clean by reducing the amount of cooking grease adhering to it.</p>
 <p>Fresh Touch: Most of Smeg ovens have a "cool door." Thanks to the combination of tangential cooling and internal heat-reflecting glasses, the temperature on the outer surface of the door is maintained below 50° C. In addition to providing safety, this system protects the sides of the furniture from overheating by the oven.</p>	 <p>Circogas: In gas ovens the fan distributes the heat quickly and evenly throughout the oven cavity, avoiding flavour transfer when cooking a number of different dishes at the same time. In electric ovens this combination completes cooking more quickly of foods that are ready on the surface, but that require more cooking inside, without further browning.</p>
 <p>Fan with upper and lower elements: The elements combined with the fan aim to provide more uniform heat, a similar method to conventional cooking, so pre-heat is required. Most suitable for items requiring slow cooking methods.</p>	 <p>Upper and lower element only: a traditional cooking method best suited for single items located in the centre of the oven. the top pf the oven will always be hottest. Ideal for roast, fruit cakes, bread etc.</p>
 <p>Lower heating element only: This function is ideal for foods that require extra base temperature without browning, e.g. pastry dishes, pizza. Also suitable for slow cooking of stews and casseroles.</p>	 <p>True European Convection: The combination of the fan and circular heating element around it provides many benefits, including no preheat if cooking time is longer than 20 minutes, no flavor transfer when cooking different foods at the same time, lower energy consumption, and shorter cooking times. Suitable for all types of food preparations.</p>
 <p>ECO: The combination of the grill, fan and lower element is particularly suitable for cooking small quantities of food.</p>	 <p>Grill element: Using of grill gives excellent results when cooking meat of medium and small portions, especially when combined with a rotisserie (where possible). Also ideal for cooking sausages and bacon.</p>

-  Fan with grill element: The fan reduces the fierce heat from the grill, providing an excellent method of grilling various foods, chops, steaks, sausages etc. giving even browning and heat distribution, without drying out the food. The top two levels recommended for use, and the lower part of the oven can be used to keep items warm at the same time, an excellent facility when cooking a grilled breakfast. Half grill (centre portion only) is ideal for small quantities of food.
-  Circulaire with upper and lower elements: The use of the fan with both elements allows food to be cooked quickly and effectively, ideal for large joints that require thorough cooking. It offers a similar result to rotisserie, moving the heat around the food, instead of moving the food itself, enabling any size or shape to be cooked.
-  The inner door glass: can be removed with a few quick movements for cleaning.
-  KEEP_WARM_72dpi
-  Side lights: Two opposing side lights increase visibility inside the oven.
-  ECO-logic: option allows you to restrict the power limit of the appliance real energy saving.
-  Air at 40°C provides the perfect environment for proving yeast type dough mixes. Simply select the function and place dough in the cavity for allotted
-  Sabbath: This function allows you to cook food during the Sabbath, the Holiday of rest in the Jewish religion, respecting the precepts. The oven works
-  The oven cavity has 5 different cooking levels.
-  Soft close: all models are equipped with advanced function of smooth closing of the door, which allows the device to close smoothly and quietly.
-  Telescopic rails: allow you to pull out the dish and check it without having to remove it from the oven entirely.
-  Vapor Clean: a simple cleaning function using steam to loosen deposits in the oven cavity.
-  The capacity indicates the amount of usable space in the oven cavity in litres.