

**IMPORTANT SAFETY INSTRUCTIONS
READ CAREFULLY AND KEEP FOR
FUTURE REFERENCE**

	3
Recognize safety information	3
General safety instruction	4
Appliance purpose	7
Proposition 65 Warning	8
Manufacturer's liability	8
Identification plate	8
Disposal	8
To save energy	9
DESCRIPTION	9
General description	9
Control panel	10
Other parts	10
Accessories	10
USE	12
Preliminary operations	12

Using the accessories	12
Display	13
First use	14
Using the oven	15
Cooking tips	25
Smart Cooking	26
History	27
Mini guide to accessories	27
Discover the recipes	27
My recipes	27
Other functions	29
Settings	35
CLEANING AND MAINTENANCE	38
Cleaning the appliance	38
Cleaning the oven cavity	38
Cleaning the door	39
Descaling	41
Extraordinary maintenance	43



We recommend that you read this manual carefully. It includes all the instructions on maintaining the esthetic qualities and functionality of the appliance you have purchased. For more information about the product: <https://www.smeg.com>

**IMPORTANT SAFETY INSTRUCTIONS
READ CAREFULLY AND KEEP FOR FUTURE REFERENCE**

WARNING: If the instructions contained in this manual are not followed precisely, fire or explosion may result causing property damage, personal injury or death.

OWNER: Please retain these instructions for future reference and pass them on to any future user.

IMPORTANT: Save these instructions for the local electrical inspector's use.

NOTICE: This appliance must be installed solely and exclusively by a qualified technician. Any technical procedures must be carried out by an authorized technician.

READ AND SAVE THESE INSTRUCTIONS

Recognize safety information

The safety messages will inform you of

potential hazards, how to avoid the risk of injury and what can occur if the instructions

are not followed.

WARNING

- This indicates that death or serious injuries may occur as a result of non-observance of this warning.

CAUTION

- This indicates that minor or moderate injuries may occur as a result of non-observance of this warning.

NOTES

- This indicates important information and/or suggestion.

General safety instruction

CAUTION

- This appliance is NOT designed for installation in manufactured (mobile) homes, on a boat or in recreational vehicles (RVs).
- DO NOT install this appliance outdoors.
- This unit is designed as a cooking appliance. For safety purposes, never use it for warming the room or as a space heater.

WARNING

- Never allow children to play with packaging material.
- DO NOT modify or alter the construction of the appliance.
- Do not store or use gasoline or other flammable vapors, liquids or materials near this or any other appliance.
- Do not step, lean or sit on the door appliance, it can result in serious injuries and cause damage to the appliance.
- Make sure your appliance is properly installed and grounded by a qualified technician. Installation, electrical connections and grounding must comply with all applicable codes.

Injury to persons

WARNING

- This appliance complies with current safety regulations. Improper use of this appliance can lead to personal injury and property damage
- During use, the appliance and its accessible parts become very hot. Small children must be kept away from the appliance.
- Do not touch the inside of the device. During use the appliance and its accessible parts become very hot even if they remain dark in color. The oven cavity can be hot enough to cause burns.
- To reduce the risk of fire, electric shock, personal injury or damage when using the device, follow these safety precautions:
 - During and after use, do not touch the inner areas of the oven cavity until they have had sufficient time to cool.
 - Do not allow clothing or any flammable material to come in contact with hot surfaces. If personal clothing or hair catch fire, roll on the ground to extinguish the flames.
 - Tie up hair to prevent it from catching fire.
 - **WEAR APPROPRIATE CLOTHING:** Never wear loose or dangling clothing when using the appliance.
 - During and immediately after use, do not hang or place objects on any part of the appliance.
 - Protect your hands by wearing oven gloves when moving food inside the oven.
 - Use only dry potholders: wet potholders on hot surfaces can cause steam burns. Do not let the potholder touch hot heating elements. Do not use towels or other bulky cloths.
 - Never attempt to extinguish flames/fire with water. Turn off the appliance and cover the flame with a lid or a fire

blanket, or use dry chemicals or foam fire-extinguishers. Alternatively, use sodium bicarbonate.

- Make sure to have foam fire-extinguishers close to the appliance.
- Use a fire extinguisher ONLY if it is Class ABC, you know how to use it, the fire is small and contained near the appliance, the fire department has already been alerted and you can fight the fire keeping your back to the exit.
- It is important for your safety to install a smoke detector near the kitchen.
- This appliance may be used by children and by persons with reduced physical, sensory or mental capacity, or without sufficient experience or knowledge, provided that they are supervised or instructed by adults who are responsible for their safety.
- Activate the system lock so that children cannot inadvertently turn on the appliance.
- Children's skin is much more sensitive to high temperatures than that of adults. Do not allow children to touch the door glass, control panel and ventilation slots.
- Children should not play with the appliance.
- Keep children away unless they are constantly supervised.
- Do not allow children to approach the appliance when it is in operation.
- Pets should not be near the appliance while it is in operation.
- Cleaning and maintenance should not be performed by children without supervision.
- Before manually cleaning any part of the appliance, make sure all controls are off and the appliance is cool. Cleaning the hot appliance can cause burns.
- Cooking process should always be kept under control. A short cooking process must be continuously surveyed.
- Never leave the appliance unattended during cooking operations where fats or

oils could overheat and take fire. Be very careful.

- Do not leave food in the appliance for a long period of time, this may cause food poisoning or illness.
- Do not introduce sealed cans for canning or reheating food. Risk of injury caused by increased pressure.
- Risk of injury caused by food.
- Do not touch a red-hot pan, risk of burns.
- Do not pour water directly on very hot trays.
- Keep the door closed while cooking or baking.
- If you need to move food or at the end of cooking, open the door 1" 15/16 (50 mm) for a few seconds, let the steam come out, then open it fully.
- Do not insert sharp metal objects (knives and utensils) into the slots.
- Turn off the appliance after use.
- Risk of injury from electric shock.
- **DO NOT USE OR STORE FLAMMABLE MATERIALS INSIDE OR NEAR THE APPLIANCE.**
- **DO NOT USE AEROSOLS IN THE VICINITY OF THIS APPLIANCE WHILST IT IS IN USE.**
- **DO NOT MODIFY THIS APPLIANCE.**
- Do not pull the cable to remove the plug.
- Damage to the device may compromise your safety; do not use it if damaged.
- **DO NOT USE THE APPLIANCE** if the door is warped, if door hinges are loose, if abnormal holes or cracks are visible, and if the power cord is damaged.

Damage to the appliance



WARNING

- Do not use abrasive or corrosive detergents (e.g. scouring powders, stain removers and metallic sponges), rough or abrasive materials or sharp metal scrapers on glass parts as this could

scratch the surface and break the glass. If possible, use wooden or plastic utensils.

- Do not sit on the appliance.
- Do not use cleaning products containing chlorine, ammonia or bleach on the steel parts or those with metallic surface finishes (e.g. anodizing, nickel or chrome plating).
- Racks and trays should be inserted as far as they will go into the side guides. The mechanical safety locks that prevent them from being removed must face downwards and towards the back of the oven cavity.

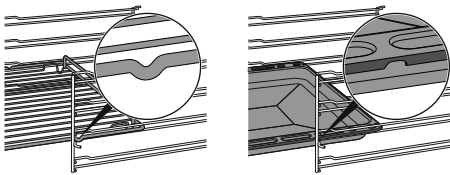

- Always place racks and trays in the desired position while the oven cavity is cold. If it is necessary to move racks and trays while the oven cavity is hot, take care that the potholder does not come in contact with the heating element.
- Do not use steam jets to clean the appliance.
- Do not use any spray products near the appliance.
- **DO NOT USE FLAMMABLE PRODUCTS FOR CLEANING THE APPLIANCE.**
- Do not clean, scrub, damage or remove the seal, which is essential for a good, airtight seal during cooking. Replace the seal if it is damaged or encrusted with food residue.
- Do not block openings, ventilation slots and heat dissipation vents. Covering the ventilation vents may cause the appliance to overheat.
- Fire hazard: never leave objects in the oven cavity.
- **DO NOT USE THE APPLIANCE TO HEAT ROOMS FOR ANY REASON.**
- Do not use this appliance as storage

space.

- Do not use plastic dishes or containers for cooking or baking food.
- Do not place sealed tins or containers in the oven cavity.
- Remove all trays and racks which are not required during cooking.
- **DO NOT COVER ANY PART OF THE APPLIANCE WITH ALUMINUM OR TIN FOIL SHEETS.** The use of aluminum covering may cause electric shock or fire hazard or obstruct the flow of heat and air. The foil is an excellent thermal insulator because it allows heat to be trapped underneath it. This can interfere with cooking and damage the enamel of the oven cavity.
- Prevent the aluminum foil from coming into contact with the heating elements.
- Do not place pots or pans directly on the bottom of the oven.
- If necessary, you can use the tray rack (supplied or sold separately, depending on the model) by placing it on the bottom as a support for cooking.
- If you wish to use greaseproof paper, place it so that it will not interfere with the hot air circulation inside the oven cavity.
- Be careful of spilling food with high sugar and acid content (fruit juices, cakes, tomatoes, milk, etc.), this may cause discoloration of enamel. Discoloration does not change the properties of the enamel; do not attempt to remove these stains.
- Be careful when cooking foods with high alcohol content (rum, brandy, bourbon, etc...). The alcohol content in food is highly flammable and can damage the oven cavity.
- Do not use the open door to place pans or trays on the internal glazing pane.
- Do not use the open door as a lever to move the appliance into place.
- Do not apply excessive pressure to the door when it is open.
- Do not use the handle to lift or move this

appliance.



NOTES

WHEN FIRST USING THIS APPLIANCE, FOLLOW THESE INSTRUCTIONS CAREFULLY:

- Set a cooking time of at least one hour.
- Heat the empty oven compartment at the maximum temperature to burn off any residues left by the manufacturing process.
- Cold temperatures can damage electronics. When using the appliance for the first time or when it has not been used for a long period of time, make sure that the appliance has been left in an environment with a temperature above 32°F/0°C for at least three hours before turning it on.

WHEN HEATING THE APPLIANCE:

- air the room;
- don't stay.
- If the appliance is built-in behind a cabinet door, do not close the door while it is in use. Closing the cabinet door may cause damage to the appliance, leave the cabinet door open until the appliance has cooled down completely.
- Do not attempt to use the appliance during a power failure.



CAUTION

- In hot and humid environments, there is a greater likelihood of infestation given by pests, and this could damage the appliance. Make sure to keep the appliance clean at all times. Damage caused by pests is not covered by the warranty.
- Make sure that the appliance has been switched off and disconnected from the mains power supply or that the mains power has been switched off before replacing the interior lighting bulbs.

Appliance purpose



CAUTION

This appliance is intended to be used in household and similar applications such as:

- In kitchen areas provided for employees in shops, offices and other work environments.
- In farms/farmhouses.
- By guests in hotels, motels and other types of residential environments.
- In bed and breakfasts.

For this appliance



CAUTION

- Do not lean or sit on the door when it is open.
- Make sure that no objects are stuck in the doors.
- Do not install/use the appliance outdoors.
- (on some models only) Only use the temperature probe provided or recommended by the manufacturer.
- This appliance can be used up to a maximum altitude of 4000 meters above sea level.
- The bulbs used in this appliance are specific for household appliances; do not use them for home lighting.

Installation and maintenance



WARNING

- Ask the installer to show the circuit breaker and fuse to prevent damage to people or the appliance during future maintenance.
- This appliance must be correctly installed and grounded by a qualified technician.
- Refer to the installation manual for further details.
- Do not repair or replace any part of the appliance unless specified in this

manual.

- Before replacing the bulbs inside the oven cavity, it is necessary to turn off the general power supply.
- The bulb guards are made of glass; handle them carefully to prevent them from breaking. Risk of injury.
- Make sure the appliance is not hot while the bulbs are being replaced.
- The appliance door is heavy, use both hands to remove it.
- The appliance door is made of glass elements, handle with care to avoid breakage. Risk of injury.
- Do not grip the appliance door by the handle but only by the side, failure to grip the door properly may result in injury.
- Do not force the appliance door open or closed. The hinges could be damaged and cause damage and injury.
- Do not rest the appliance door on pointed objects, this may cause the glass to break.
- Do not use this device if it is not working properly or if it has been damaged. In such a case, contact customer service.

Proposition 65 Warning

This product may contain a chemical known to the State of California, which can cause cancer or reproductive harm. Therefore, the packaging of your product may bear the following label as required by California:



WARNING
State of California propositions 65
Warning

- Cancer or Reproductive Harm

More informations:
www.P65Warnings.ca.gov

Manufacturer's liability

The manufacturer accepts no liability for damage to persons or property caused by:

- use of the appliance in any way other than stipulated herein;

- failure to comply with the instructions in the User Manual;
- tampering with any part of the appliance;
- use of after-market replacement parts.

Identification plate

- The identification plate contains model, technical data, serial number and brand name of the appliance.
- It is the responsibility of the installer to comply with the installation information specified on the identification plate.
- Identification plates are visibly placed on the back of the appliance or on the frame of the oven cavity.
- THE IDENTIFICATION PLATE SHOULD NEVER BE REMOVED.

Disposal



WARNING

Entrapment risk for children. Before you throw away an old appliance:

- Remove the doors.
- Leave the racks and the trays positioned so that children cannot easily climb inside.
- Do not leave the packaging or any parts of it unattended.
- Destroy or recycle cardboard, plastic bags, and any outer packaging material immediately after unpacking the appliance. Children should NEVER use these items for play. They can cause suffocation and death.



CAUTION

- Take the appliance to a suitable recycling center for electric and electronic waste, or return it to the dealer when purchasing an equivalent product, as a one-on-one exchange.

Before you throw away an old appliance:

- Unplug the power cord plug.
- Cut the power cord.
- Do not allow children to climb, stand on,

or attach themselves to the appliance's racks and trays.

- Do not allow children to play with the appliance.

To save energy

It is highly recommended to follow the recommendations below to reduce energy consumption.

- Only preheat the appliance if the recipe requires you to do so.
- In all functions, avoid opening the door during cooking.
- Unless otherwise indicated on the packaging, defrost the frozen food before placing it in the oven cavity.

- In case of multiple cooking, it is advisable to cook the products one after the other to make the most of the already hot oven cavity.
- It is preferable to use dark metal pans, which help to absorb the heat better.
- Remove all trays and racks which are not required during cooking.
- Turn off the oven a few minutes before the time required. Cooking will continue for the remaining minutes with the heat already accumulated inside the oven.
- Do not open the oven door very often to avoid heat loss.
- Keep the inside of the oven clean at all times.

DESCRIPTION

General description

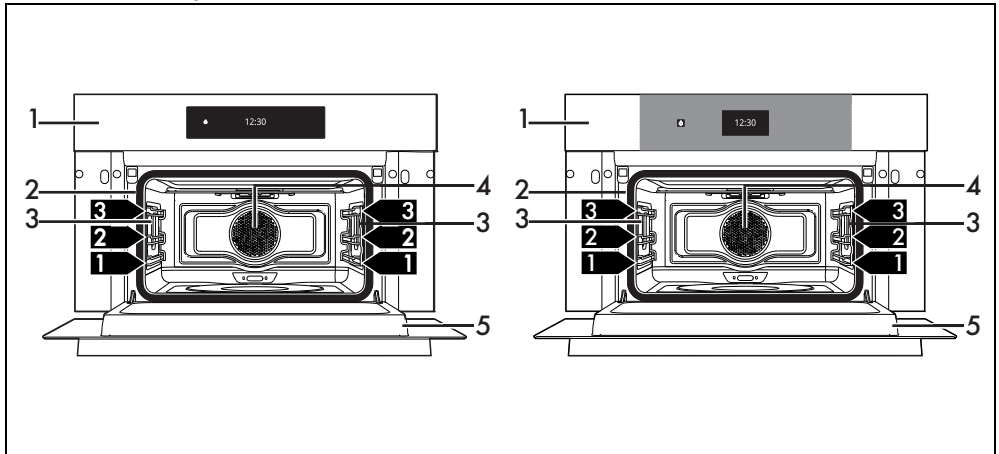

1 Control panel

2 Gasket

3 Light bulb

4 Fan

5 Door

1,2,3  Frame shelf

Control panel

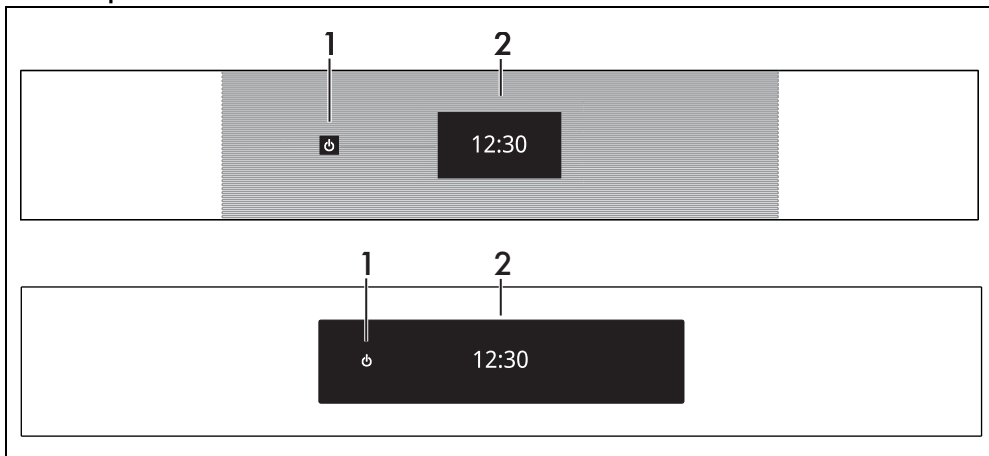

1 ON/OFF button

The ON/OFF button turns the appliance on or off.

2 Display

The touchscreen display allows you to interact with the appliance. Touch the icons to access the various functions. All the operating parameters will be shown on the display.

Other parts

Positioning shelves

The appliance has shelves for positioning trays and racks at various heights. The insertion heights are indicated from the bottom upwards.



NOTES

- Any telescopic rails can be hooked up to the fifth shelf from below. The sixth shelf does not allow the rails to be hooked.

Cooling fan

The fan cools the appliance and comes into operation during cooking.

The fan causes a steady outflow of air from above the door which may continue for a short period of time even after the appliance has been turned off.

Oven cavity lighting

The internal lighting for the appliance turns on:

- when the door is opened;
- during one function, touch the light symbol



to manually activate or deactivate the

oven cavity light, apart from the



functions.



NOTES

- In order to save energy, the light turns off after about one minute from the start of cooking or whenever the door is opened (this function can be disabled via the secondary menu).

Accessories

- Not all accessories are provided on all models.
- Accessories that may come into contact with food are made of materials that comply with all legal provisions in force.
- Original accessories supplied or optional can be purchased at authorized service centers. Only use original manufacturer's accessories.

Sponge

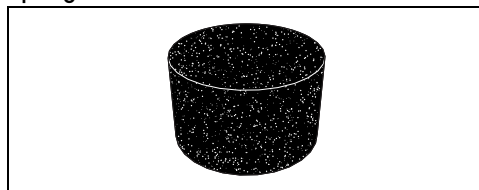

Useful for removing condensation from inside

the oven.

Jug

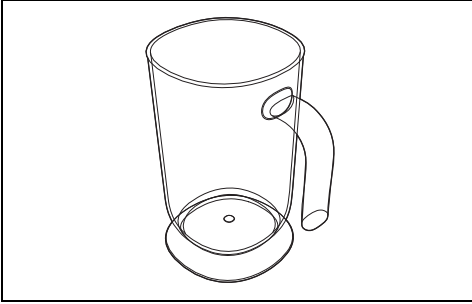

Useful for containing liquids during filling and emptying of the tank.

Evaporation tray and lid

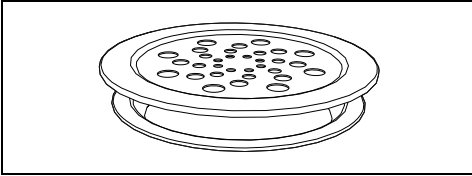

NOTES

- The maximum capacity of the evaporation tray is 250 ml

Distributes the steam inside the oven cavity.

Steel tray

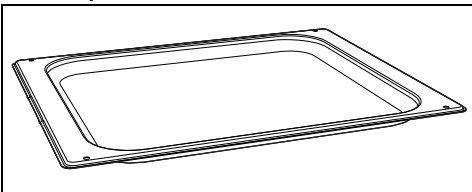

Useful when cooking cakes (with cooking times of less than 25 minutes or without steam), rice, beans and cereals. It is also essential for collecting liquids produced by steaming or defrosting foods contained in the perforated tray above.

Perforated tray

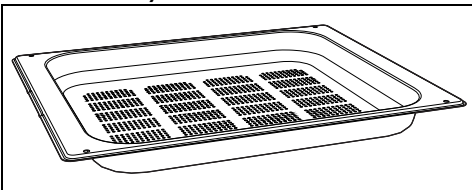

Useful for steaming fish and vegetables.

Deep tray

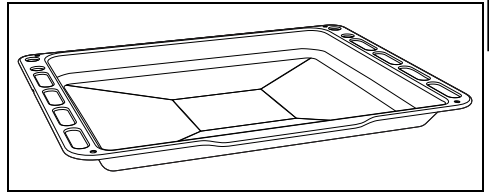

Useful for collecting fat from foods placed on the rack above and for cooking pies, pizzas, baked desserts, biscuits, etc.

Tray rack

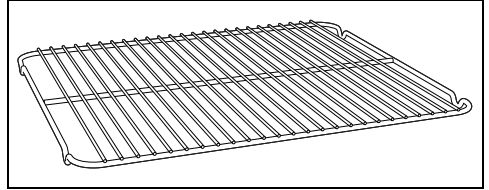

To be placed over the top of the oven tray; for cooking foods which may drip.

Rack

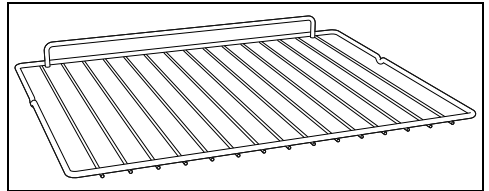

Used for supporting containers with food during cooking.

Optional accessories (can be purchased separately)

PPR2 or STONE (refractory stone)

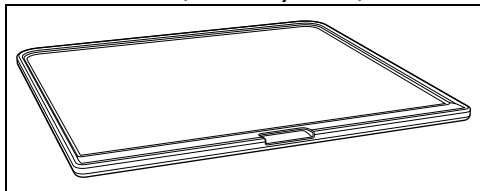

Ideal accessory for baking bread (pizza, bread, focaccia...), but you can also use it for more delicate preparations such as biscuits.

BBQ (teflon-coated barbecue grill pan)

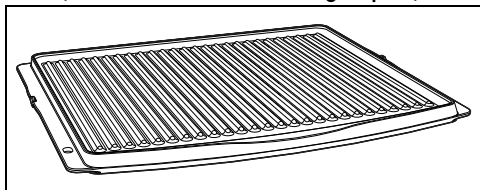

Double-use accessory: the ridged side is recommended for grilling meat (fillets,

hamburgers...), while the smooth surface can be used for cooking vegetables, fruit, fish...

AIRFRY (oil-free frying grill)

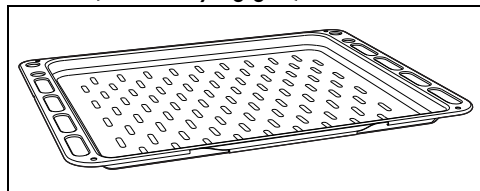

Recommended accessory for air-frying previously breaded, precooked and/or frozen food (fries, potato or meat croquettes, small mozzarella bites...).

USE

Preliminary operations

WARNING

- Remove all protective film from the outside and inside of the appliance and accessories.
- Remove any labels (apart from the technical data plate) from the accessories and shelves.
- Remove and wash all the appliance accessories (see chapter "CLEANING AND MAINTENANCE").

First heating

1. Set a cooking time of at least one hour (see paragraph "Using the oven").
2. Heat the empty oven compartment at the maximum temperature to burn off any residues left by the manufacturing process.

When heating the appliance

- air the room;
- don't stay.

Using the accessories

WARNING

- Accessories that can be purchased separately (BBQ and STONE), should be placed on the rack. They should not be placed on the bottom of the cooking compartment, risk of damage to the appliance.

Racks and trays

Racks and trays have to be inserted into the side guides until they come to a complete stop.

- The mechanical safety locks that prevent the rack from being removed accidentally must face downwards and towards the back of

the oven cavity.

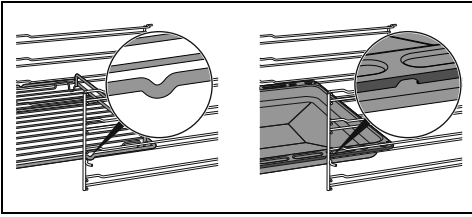

NOTES

- Gently insert racks and trays into the oven until they come to a stop.
- Clean the trays before using them for the first time to remove any residues left by the manufacturing process.

Display

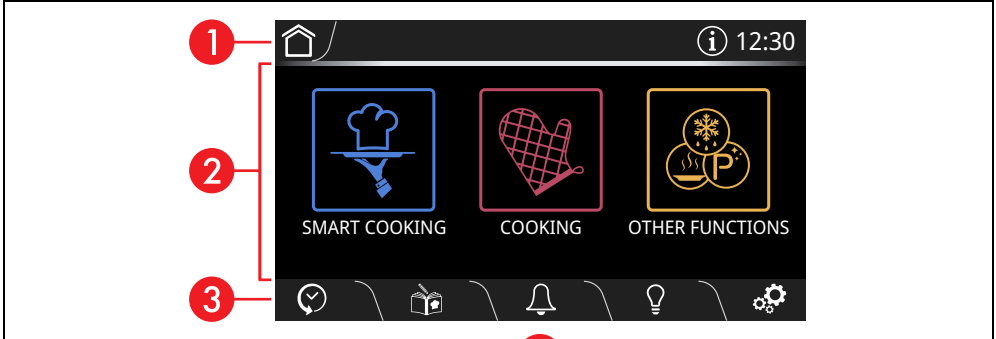

The parameters and values for the currently selected function will be indicated on the display. To use it, simply touch the "virtual" buttons and/or scroll through the values shown (the picture shows the main menu screen).

1 Information area

Information regarding the menus and sub-menus of the functions in progress in the main area are shown in this area.

The following are also present in this area:

- HOME  button: touch this button to return to the main menu;
- INFORMATION  button: touch this button to display the following screen:

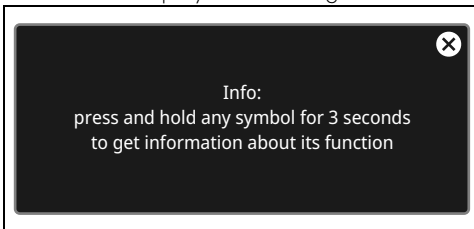

- current time display.

2 Main area

The various functions of the appliance can be set in this area. Touch the buttons and values to set the required function.

3 Lower area

There are various shortcut function buttons in this area, which vary according to the functions set in the main area:

-  HISTORY
-  TIMER
-  MY RECIPES
-  LIGHT
-  SETTINGS

According to the page that is displayed, the following buttons may also be present:

-  BACK
-  CONFIRM
-  START
-  REPLAY
-  STOP
-  SAVE
-  DELETE
-  RAPID PREHEATING

 PROBE (on some models only)

NOTES

- Press and hold the HOME  button or the ON-OFF  button for a few seconds to stop cooking immediately at any time and return to the main menu.

First use

NOTES

- The following instructions are also valid in the case of a prolonged power failure.

To switch the appliance on:

1. Connect the appliance to the mains power supply.

The manufacturer's logo will display for a few seconds.

NOTES

- After the appliance is switched on, you will need to wait a few seconds before you can use it.

Next, the display shows the setting screen for the current time.

To be able to start any cooking function, the current time must be set.

2. Scroll up and down through the hours and minutes to set the current time.

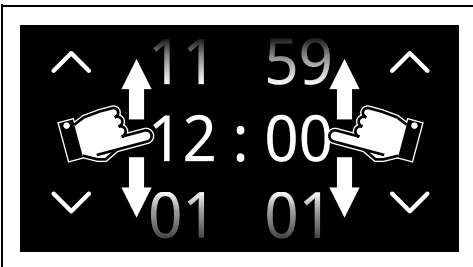





3. Touch the CONFIRM  button (at the right in the lower area ) to set the current time.

NOTES

- To change the current time (e.g. due to summer/winter time), touch the time shown on the display (located in the information area  on the right).
- The current time can also be set or modified by touching the time indicated on the display for at least 3 seconds.

When first used, the appliance may be set to a different language from yours. It is recommended that you set the required language at this point.

4. Touch the SETTINGS  button on the display (at the right in the lower area )
5. Touch the display  button.
6. In the Language  option (on the left), scroll through the available languages (on the right) to select the required language.
7. Touch the CONFIRM  button.

Deactivating the display

NOTES

- When the  "Show the time" mode is set to Off, if the time display is shown, the display will switch off automatically after 2 minutes.

To deactivate the display manually:

- Press and hold the ON-OFF  button for a few seconds until you hear a sound.

Reactivating the display

To reactivate the display when it is off:



- Press and hold the ON-OFF  button for a few seconds until you hear a series of sounds.

The display turns on after a few seconds. The display shows the main menu when it is switched

on again.

NOTES

In some cases, the ON-OFF  button does not deactivate the display. For example, when:

- There is a cooking function in progress (the button stops the function);
- The door is open;
- A minute minder timer is active;
- the  Show Room and/or  Demo modes are active.

Using the oven

WARNING





Steam cooking

NOTES

- Do not place food or any other object directly on the bottom of the oven. The base of the oven and the evaporation tray must always be left free.
- If cooking has just been performed with temperatures over 210°F/100°C, you must wait for the oven to cool in order to use the steam function.

1. Place the food inside the oven.
2. Touch the time indicated on the display.



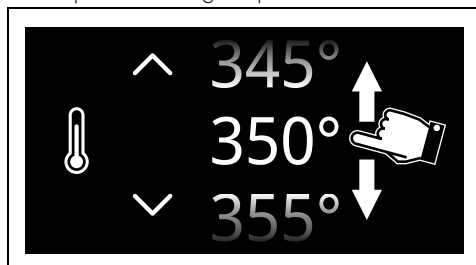

3. Touch the COOKING  button on the "main menu" (in the main area ).
4. Select a desired function (for example STEAM)  to enter the relevant cooking screen.
5. Touch the TEMPERATURE  button or the relevant value.

6. Scroll through the values and select the required cooking temperature.



NOTES

- The minimum temperature that can be set is 125°F/50°F
7. Touch the CONFIRM  button (at the lower right ) to confirm the new cooking temperature that has been selected.
 8. Touch the COOKING DURATION  button or the relevant value.
 9. Scroll through the values and select the required duration.

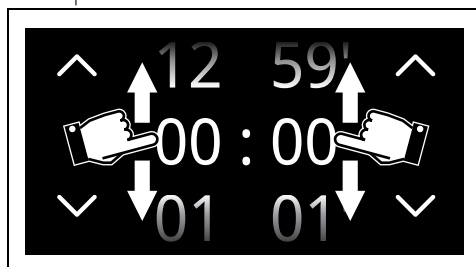

10. Touch the CONFIRM  button to confirm the selected cooking duration.

NOTES

- The hours and minutes can be selected separately.
- The duration of steam cooking can be from a minimum of 1 minute to a maximum of 1 hour and 59 minutes.

The time expected for the end of cooking

displays under the duration.

NOTES

- The minutes required for preheating are already included in the end-of-cooking time.

1.1. Touch the **START**  button to start the reservoir filling procedure.

Reservoir manual filling

NOTES

- Use cold tap water which is not too hard, softened water or still mineral water.
- Do not use distilled water, tap water with a high chloride content (> 40 mg/l), or other liquids.

1. Fill the jug or a container with a sufficient amount of water for the functions that you wish to use.
2. Open the oven door.
3. Place the jug (or container) on the open door.

NOTES

- The jug or container with the water must have a gross weight lower than 5 kg.
- Do not place the jug (or container) on the glass of the door. Rest the jug on the opaque surface of the door at the tube.

4. Remove the tube from its seat.

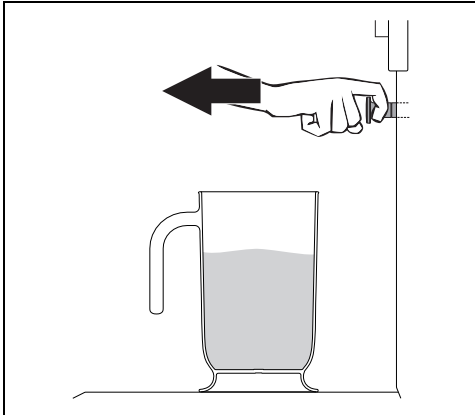

5. Place the end of the tube at the bottom of the jug (or container).

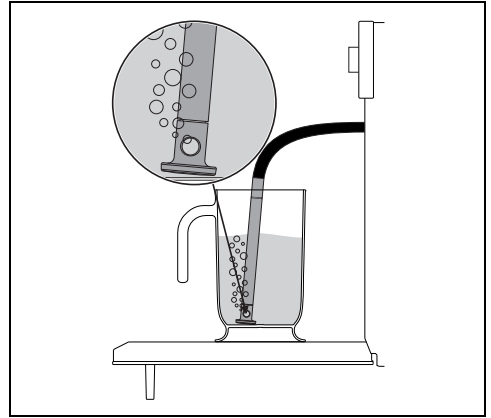

6. Press the **START**  button to start filling the appliance reservoir with water. This step is indicated by this wording: "Reservoir filling in progress."

NOTES

- The appliance will automatically draw the quantity of water necessary for cooking on the basis of the set duration.
- In the event that the water runs out, the appliance will automatically stop the cooking process, a buzzer will sound and the display will show a request to fill the reservoir with water.

7. When finished, shake the tube in order to remove any remaining water.

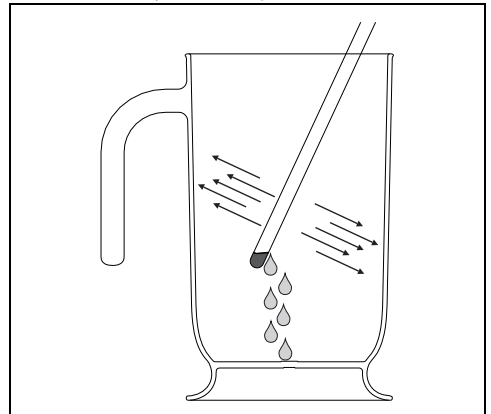

8. Place the tube back into its seat and remove the jug (or container)

9. Close the door.



NOTES

- When the door is closed, a system will automatically draw in any residual water from the loading nozzle to avoid drips. A bubbling noise may be heard; this is completely normal.

10. Touch the CONFIRM  button to confirm that you have finished filling the reservoir.

The appliance starts the function using the parameters set.



NOTES

- Each time the door is opened, the function in progress will stop and then automatically restart when the door is closed again.

Pre-heating stage

Steam cooking is always preceded by the pre-heating stage that allows the oven cavity to heat up to the set cooking temperature.

This stage is indicated by a progressive increase in the temperature level reached.



NOTES

- Pre-heating cannot be bypassed when steam cooking is used.

At the end of preheating the temperature reaches the maximum set level. A buzzer sounds and a message appears on the display to indicate that cooking starts automatically.

End of steam cooking

At the end of cooking, "Function ended" displays and a buzzer sounds briefly.



- Touch the HOME  button to exit from the function.

Removing the residual water

At the end of steaming, the water can be

emptied from the reservoir.



NOTES

- We recommend emptying the reservoir after each cooking cycle to avoid scale build-up.

1. Touch the HOME  button to exit the function: the appliance prompts you to drain the water from the reservoir.

Remember to connect the probe to the oven and to insert it into the food

2. Stand to the side of the appliance and open the door ajar for a few seconds to allow excess steam to escape.
3. Fully open the door when safe to do so and cautiously remove the food from the oven.
4. Place the jug provided (or a container) on the open door.



NOTES

- Do not place the jug (or container) on the glass of the door. Rest the jug on the opaque surface of the door at the tube.
5. Remove the tube from its seat and insert the end of it into the jug (or container).

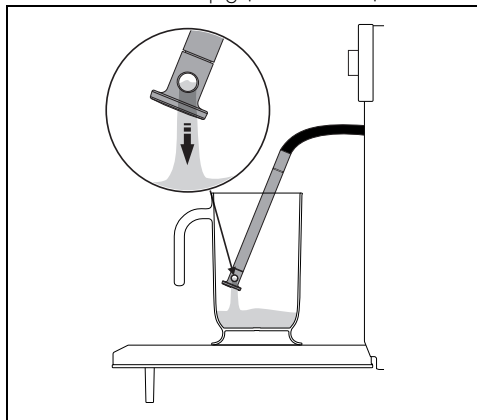

6. Press the START  button to start draining the water into the jug (or container). This

step is indicated by this wording: "Reservoir drain in progress."

NOTES

- It is only possible to drain the water when the door is open. Always make sure that you have removed the tube from its seat and inserted its end into the jug (or container) before pressing the START button  to start the draining cycle.

- When complete, the display will indicate that the residual water removal process is complete.
- Touch the CONFIRM  button.
- Shake the tube in order to remove any remaining water.

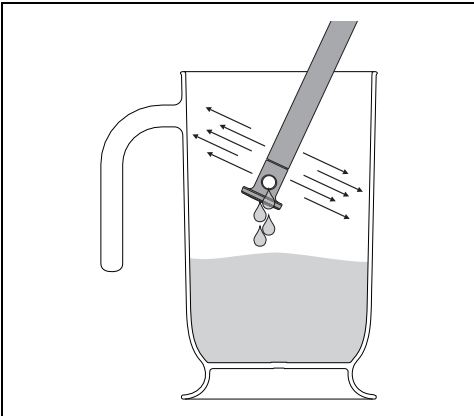

- Place the tube back into its seat and remove the jug.

- Remove the cover from the evaporation tray inside the oven cavity and dry it with the sponge provided.

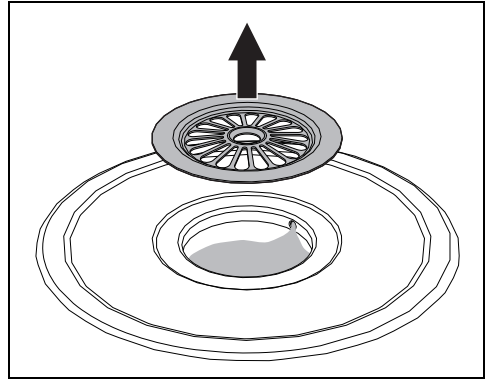

NOTES

- The evaporation tray cover may be very hot: use appropriate protection.

- Remove condensation from the base and walls of the oven cavity, the door glass and drip tray, the front of the appliance using a sponge.

WARNING

- Take care: the water may be very hot.

Advice for steam cooking

- Pasta and rice:** upon reaching 100°C, the cooking time will be the same as with cooking on a cooktop. Place the pasta or rice in a metal tray and cover with around a centimeter of water. For best results when cooking rice, place a lid on the container or cover with aluminum foil. This procedure allows the rice to absorb all the water, and it can then be served directly to the table.
- Eggs:** these may be **boiled**, **scrambled** or **poached** by using the steam function at 100°C. To obtain perfect **boiled eggs**, place them on the perforated tray and cook for 4-6 minutes for soft boiled eggs and 8-10 minutes for hard-boiled eggs. For **scrambled eggs**, place beaten eggs in metal pan along with milk, butter, and seasoning. Cover the tray with aluminum foil. Mix every couple of minutes using a fork. For **poached eggs**, pour boiling water into the metal tray with a drop of vinegar and steam cook for around 4-5 minutes.

- **Vegetables:** steam cooking vegetables gives excellent results. They maintain their color, flavor and nutritional properties. For dense vegetables such as potatoes, turnips and parsnips, cook at 100°C for the same length of time you would boil them on a cooktop. For broccoli and carrots, cook for 6 minutes if you want them to remain firm, or 10 minutes if you want them to be softer.
- **Fish:** due to the delicate nature of fish, steaming gives excellent results. For oily fish such as salmon or trout, cook at 100°C for around 5 minutes. For white fish such as cod or haddock, cook at 80°C for around 5 minutes. If you are cooking different foods, all fish must be cooked in the perforated tray which must be placed on the bottom shelf of the oven to avoid liquid from the fish dripping onto other food products.
- **Meat:** casseroles and curries are ideal for steam cooking. Prepare the casserole as for normal oven cooking. Place it in a metal tray, cover with a lid or aluminum foil, and cook for between 45 minutes and 3 hours depending on the cut of meat used.
- **Thin soups:** steam cooking allows flavors to develop perfectly with minimum effort, as the liquids will not boil over. For vegetable soup with the correct consistency, first steam the vegetables, then add broth and steam cook at 100°C. The steam function is also ideal for preparing large quantities for later use.
- **Soups:** Thicker soups are also easy and quick to prepare. Place the soup in a metal tray, cover with a lid or aluminum foil and steam cook at 100°C for the same time you would cook it in a microwave oven. To obtain a creamy texture stir halfway through cooking.
- **Reheating:** the steam cooking function will not dry foods out and gives a moister result. A previously prepared home-cooked meal, covered with aluminum foil, will take around 10-12 minutes to reheat. Ready meals will require approximately double the time indicated on the package.
- **Defrosting:** it is possible to use the steam function to defrost foods. Times vary, but defrosting with the steam cooking function takes around half the time necessary for covered foods left to defrost at room temperature.
- **Peeling peppers and tomatoes:** this is very easy to do when using the steam function.

Use a knife to cut a small cross in the skin of the tomato, and steam cook for 1 minute. Peppers have tougher skin, and may require up to 4 minutes to soften it sufficiently for peeling.

- **Chocolate:** this can be melted using the steam cooking function. Place the chocolate in a metal tray, cover with aluminum foil and steam cook for 1 minute. Unlike other methods, chocolate is unlikely to burn in the steam oven
- **Hot towels:** ideal for facial treatments, a close shave or for use after a meal, these are easy to prepare using the steam cooking function. Moisten a towel with water, roll it up and steam it for 1 minute.

Sous Vide cooking



SOUS VIDE

Steam function for perfect cooking inside a sealed bag. The food's flavors are enhanced and no nutrients are lost.



NOTES

- The bag containing the food can be placed on the perforated tray or on a rack positioned on the first or second shelf.

Sous Vide cooking in a steam oven is the best way to cook food without altering its nutritional properties and quality. It is also an extremely healthy and natural type of cooking.

- The Sous Vide technique allows the heat to be transferred efficiently from the steam to the food, preventing the loss of flavor through the oxidation and evaporation of nutrients and humidity during cooking.
- Sous Vide cooking also allows greater control over the cooking compared to traditional methods and ensures that cooking is uniform.
- It also allows cooking to be carried out at lower temperatures compared to traditional cooking methods.

For Sous Vide cooking you need to:

- Have a chamber vacuum packing machine that allows you to achieve a better and safer vacuum for solid and liquid foods.
- Make sure that the seal area of the bag is clean and free from food residues.
- Hermetically seal the food in a special food grade bag that can withstand the cooking temperatures.

- Create a vacuum in the bag of at least 99.8% to prevent air bubbles forming inside that could affect the cooking.
- If you have a Smeg vacuum drawer, use the maximum vacuum level (level 3).

Once cooked, it is recommended to remove the product from the bag and finish cooking it in a pan or by grilling.



Useful tips:

- It is recommended to use fresh, quality foodstuffs that have been well preserved until cooked.
- Seasoning can be added to the bag in order to improve cooking results.
- Remove all bones from the foods that could pierce the bag and affect cooking.
- Do not leave the food to be cooked at room temperature for too long as the bag may inflate during cooking and lose all the advantages of vacuum sealing it.
- The food to be vacuum-sealed for Sous Vide cooking or for storage should be at fridge temperature (37°F/3°C to 45°F/7°C), never hot.
- Keep vacuum-sealed products (cooked and then blast chilled) in the fridge at a constant temperature and not above 37°F/3°C.
- In order to cook the food uniformly, place the food on one layer and do not overfill the bags.
- If you are cooking different foods at the same time, place the bags on the same shelf without overlapping them.
- Do not reuse the bags after cooking.

To select the Sous Vide cooking:



1. Touch the COOKING  button on the "main menu".
2. Select the SOUS VIDE  function.
3. For settings, see the procedure described in the "Steam cooking" section.

Combined cooking with steam

1. Touch the COOKING  button on the "main menu".
2. Select a combination function (for example STEAM CONV. BAKE ) to enter the relevant cooking screen.

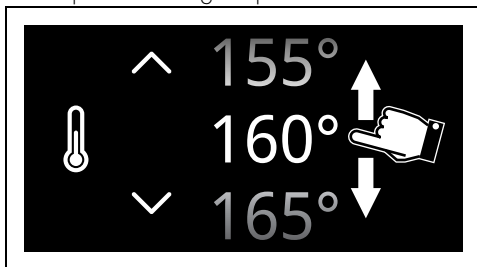

3. Touch the TEMPERATURE  button or the relevant value.
4. Scroll through the values and select the required cooking temperature.

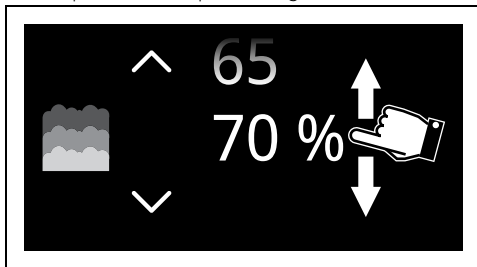

5. Touch the CONFIRM  button (at the lower right **3**) to confirm the new cooking temperature that has been selected.
6. Touch the STEAM PERCENTAGE  button or the relevant value.
7. Scroll through the values and select the required steam percentage.



NOTES

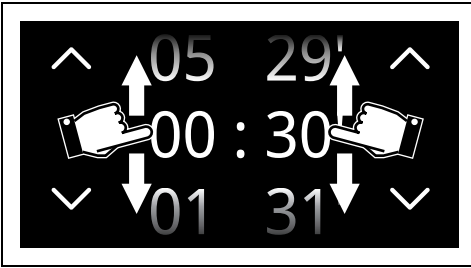

- 25% - Cakes and bread
 - 30% - Duck
 - 40% - Beef, veal and lamb
 - 50% - Chicken
 - 70% - Whole fish
8. Touch the CONFIRM  button to confirm the selected steam percentage.
 9. Touch the COOKING DURATION  button or the relevant value.

10. Scroll through the values and select the required duration.



NOTES

- The hours and minutes can be selected separately.
- The duration of the combined steam cooking can be from a minimum of 1 minute to a maximum of 12 hours and 59 minutes.
- Underneath the duration, the expected time for the end of cooking is displayed, in which the minutes needed for preheating are already calculated.

11. Touch the CONFIRM  button to confirm the selected cooking duration.
12. Touch the START  button (at the lower right ) to start to fill the reservoir.
13. Fill the reservoir as described in the chapter "Reservoir manual filling".

Pre-heating stage

Combination cooking is always preceded by the pre-heating stage that allows the oven cavity to heat up to the set cooking temperature. This stage is indicated by a progressive increase in the temperature level reached.



NOTES

- Unless otherwise indicated in the recipe, it is not recommended to place food in the oven during the preheating stage.
- You can skip the pre-heating stage touching the dedicated button .

At the end of preheating the temperature reaches the maximum set level. A buzzer sounds and a message appears on the display to

indicate that cooking starts automatically.



1. Open the door
2. Place the food inside the oven.
3. Close the door.
4. Touch the CONFIRM  button to start cooking.

End of combination cooking

At the end of cooking, "Function ended" displays and a buzzer sounds briefly.



5. Drain the reservoir as described in the chapter "Draining the residual water".

List of combined cooking functions

STEAM CONVECTION ROAST



Intense and even cooking. The addition of steam allows better preservation of the organoleptic properties of food. Ideal for roasting veal, duck and cooking whole fish.

STEAM CONVECTION BAKE



The addition of steam to true convection cooking allows better preservation of the organoleptic properties of food. Ideal for preparing roasts, chicken, and baked goods such as leavened cakes and bread.

Traditional cooking

NOTES

- Each time the door is opened, the function in progress will stop and then automatically restart when the door is closed again.

1. Touch the time indicated on the display.



that the dish can be put in the oven cavity.



2. Touch the COOKING  button on the "main menu" (in the main area **2**).

3. Select a desired function (such as TRUE

CONVECTION ) to enter the relevant cooking screen.

4. Touch the START  button (at the lower right **3**) to start pre-heating.

Pre-heating stage

Cooking itself is preceded by a preheating stage, which allows the appliance to heat to the cooking temperature more quickly.

This stage is indicated by a progressive increase in the temperature level reached.



NOTES

- Unless otherwise indicated in the recipe, it is not recommended to place food in the oven during the preheating stage.

NOTES

- You can skip the pre-heating stage touching the dedicated button .

After pre-heating, a buzzer will sound and a message will appear on the display to indicate

Cooking phase

5. Open the door

6. Place the dish with the food to be cooked into the oven cavity.

7. Close the door.

8. Touch the CONFIRM  button to start cooking.

This step is indicated by this wording: "FUNCTION IN PROGRESS".

NOTES

Once cooking has started, it is possible to set timed cooking:

- Touch the TIME  button and follow the instructions in the "timed cooking" section.

Modifying the cooking temperature

NOTES

- The temperature can be modified at any time during cooking.

1. Touch the TEMPERATURE  button or the relevant value.

2. Scroll through the values and select the required cooking temperature.

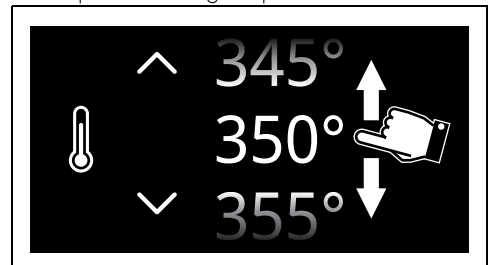

3. Touch the CONFIRM  button (at the lower right **3**) to confirm the new cooking temperature that has been selected.

End of cooking

To end cooking at any time:

1. Touch the STOP button .

Timed cooking



NOTES

- Timed cooking is the function which allows a cooking operation to be started and then ended after a specific length of time set by the user.

1. After selecting a function, touch the TIME  button or the related value.
2. Scroll through the values and select the required duration.

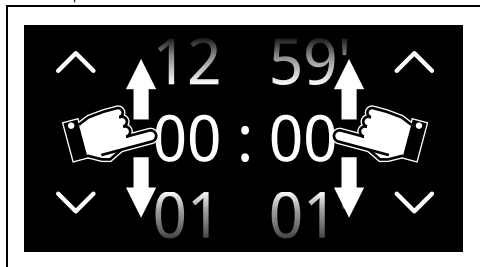

3. Touch the CONFIRM  button to confirm the selected cooking duration.



NOTES

- The hours and minutes can be selected separately.
- The duration of the timed cooking can be from a minimum of 1 minute to a maximum of 12 hours and 59 minutes.

The time expected for the end of cooking displays under the duration.



NOTES

- The countdown starts after the pre-heating has ended or if you wish to skip pre-heating (touch the relevant button .
- The minutes required for pre-heating are already included in the end-of-cooking time.

4. Touch the CONFIRM  button to start timed cooking.

This stage is indicated by a progressive increase

in cooking.



ZE

Delayed cooking



NOTES

- For safety reasons, it is not possible to set the end of cooking time by itself without setting the cooking duration.
- Delayed cooking is the function which allows a time-controlled cooking operation to be stopped at an established time depending on the time set by the user, after which the appliance will switch off automatically.

1. After setting timed cooking, touch the DELAYED COOKING  button or the relevant value.
2. Scroll through the values and select the required end of cooking time.

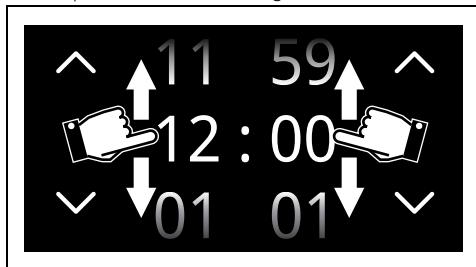

NOTES

- The hours and minutes can be selected separately.

3. Touch the CONFIRM  button to confirm the selected end of cooking time.

This stage is indicated by a progressive increase in cooking.



End of cooking

At the end of cooking, "Function ended" displays and a buzzer sounds briefly.



- Touch the HOME  button to exit from

the function.

List of traditional cooking functions



NOTES

- Not all functions are available on some models.
- In the "PIZZA" cooking function, the temperature probe cannot be used.

BAKE



Traditional cooking, ideal for preparing a single dish. For example cooking roast meats, fatty meats, bread, pies.

CONVECTION BAKE



Intense and uniform cooking. Ideal for biscuits, cakes and cooking on more than one level.

TRUE CONVECTION



The heat is distributed quickly and uniformly. Suitable for all dishes, ideal for cooking on multiple levels without mixing smells or flavors.

CONVECTION ROAST



Allows quick cooking on multiple shelves without mixing the aromas. Perfect for large volumes that call for intense cooking.

BROIL



Produces excellent grilling and browning results. When used at the end of cooking, gives a uniform browning to dishes.

CONVECTION BROIL



Allows optimal grilling, even for thick slices of meat. Perfect for large cuts of meat.

WARM



The heat comes from the bottom of the cavity only. Perfect for cakes, pies, tarts and pizzas.

EUROPEAN BAKE +



Allows you to quickly finish cooking food that is already cooked on the surface but not internally. Ideal for quiches, suitable for all kinds of dishes.

PIZZA



Function designed for cooking pizza. Perfect not just for pizzas, but also for biscuits and cakes.

Minute minder timer





NOTES

- This function only activates the buzzer, without stopping the function in progress.
- The Timer can be set from a minimum of 1 minute to a maximum of 12 hours and 59 minutes.

1. Touch the **TIMER**  button (in the lower area **3**) to access the Timer menu.

Up to 2 minute minder Timers can be set:

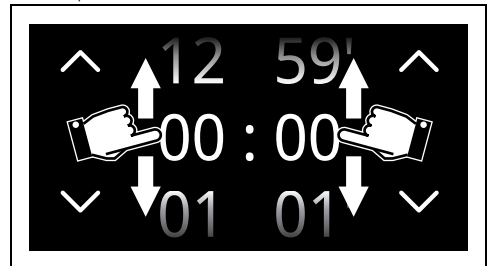

2. Touch the button of the **TIMER**  -  that you intend to use.
3. Scroll through the values and select the required duration.



4. Touch the **CONFIRM**  button to confirm the selected duration.



NOTES

- The **BASKET**  button displays in the lower area **3** that can be used to delete a timer if it has been selected.
5. Repeat the procedure for the other Timers that you intend to use.
 6. When finished, touch the **CONFIRM**  button again to confirm the selected timers.





NOTES

- To cancel the operation, touch the **RETURN**  button



NOTES

- The counter must be set to zero in order to remove the minute minder timer.
- The display cannot be switched off using the ON-OFF  button when a timer is active.
- It is not possible to set delay cooking when the temperature probe is used.

In the following display, the TIMER  button ON, indicates that one or more minute minder timers have been activated.

7. Wait for the buzzer to indicate that the time has finished.

Cooking tips

General tips

- Use a fan function to achieve uniform cooking at several levels.
- Increasing the temperature does not shorten cooking or baking times (the food could be well cooked on the outside and undercooked on the inside).
- To prevent condensation from forming on the glass, hot food should not be left inside the oven for too long after cooking.

Tips for cooking meats

- Cooking times vary depending on the thickness and quality of the meat, and on consumer tastes.
- For meat and potatoes, it is recommended from time to time to turn and/or mix the food to obtain a uniform browning on all sides.
- Use a meat thermometer when cooking roasts, or simply press on the roast with a spoon. If it feels hard, it is ready; otherwise, it needs to roast a bit longer.
- For low temperature cooking, brown the meat in a pan for a few minutes on all sides before baking in the oven.

Advice for cooking with the Grill

- The meat can be grilled starting with a cold oven or with the oven preheated if you want to change the effect of the cooking.
- When using the convection broil function (if any), it is recommended to preheat the oven cavity before grilling.

- We recommend placing the food at the center of the rack.
- With the broil function, we recommend that you set the temperature to the maximum value to optimize cooking.

Tips for baking cakes and cookies

- It is preferable to use dark metal pans, which help to absorb the heat better.
- The temperature and baking duration depend on the quality and consistency of the dough.
- To check whether the cake is baked through, stick a toothpick into its highest point at the end of the baking time. If the dough does not stick to the toothpick, the dessert is cooked.
- If the dessert goes flat when it comes out of the oven, on the next occasion reduce the set temperature by about 50°F/10°C, selecting a longer baking time if necessary.

Tips for cooking on two shelves:

- It is recommended to have 2 racks (can be requested to Authorized Assistance Centers).
- To facilitate the flow of air, place the molds/pans in the center of the racks and make sure that their width/diameter does not exceed 11" 13/16 (300 mm).
- Position the racks keeping an empty level between them.
- Depending on the food and the increased load inside the cavity, cooking on two levels may take a few minutes longer than on a single shelf.
- The functions indicated for cooking on two shelves are TRUE CONVECTION and EUROPEAN BAKE +.

Tips for defrosting and leavening



- Place frozen foods without their packaging in a lidless container on the first shelf of the oven.
- Do not overlap foods.
- To defrost meat, use a rack placed on the second level and a tray placed on the first level. This way, the meat does not remain in contact with the liquid from thawing.
- The most delicate parts can be covered with aluminum foil.
- For successful proving, a container of water should be placed in the bottom of the oven.

To save energy

- Turn off the oven a few minutes before the time required. Cooking will continue for the remaining minutes with the heat already accumulated inside the oven.
- Do not open the oven door very often to avoid heat loss.
- Always keep the inside of the appliance clean.

Smart Cooking

This mode allows you to select a previously stored program for cooking food. The appliance automatically calculates the optimum cooking parameters based on the weight selected.

1. Touch the SMART COOKING  button on the "main menu" (in the main area **2**).
2. Select the type of dish required from the SMART COOKING menu (for example "VEGETABLES" ).
3. Select the sub-category of dish to cook (for example "MIXED VEGETABLES" .
4. Scroll through the values to set the weight of the food to be to cook.

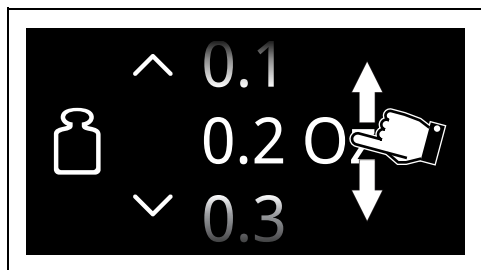

5. Touch the CONFIRM  button to confirm the settings.

NOTES

- It is now possible to save the settings as a personal recipe (see section "My recipes").

6. Touch the START  button to start SMART COOKING.
Cooking will start with the settings specified in

the program.

NOTES

- The cooking temperature and duration can be changed at any time, even after cooking has started.

Pre-heating

Cooking is preceded by the pre-heating stage that allows the oven to heat up to the set cooking temperature.

This stage is indicated by a progressive increase in the temperature level reached.



NOTES

- The pre-heating function cannot be disabled when **Smart Cooking** programs are being used.

After pre-heating, a buzzer will sound and a message will appear on the display to indicate that the food can be put in the oven.

The shelf on which the food should be placed in order to obtain best results is also indicated.

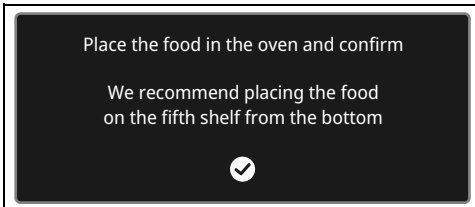

7. Open the door
8. Place the food inside the oven.
9. Close the door
10. Touch the CONFIRM  button to start cooking.

This stage is indicated by a progressive increase in cooking.



End of cooking

At the end of cooking, "Function ended" displays and a buzzer sounds briefly.



11. Touch the HOME  button to exit from function. End of cooking.

History

This menu is particularly useful for viewing and reusing the last programs or personal recipes that were used.

1. Touch the HISTORY  button on the "main menu" (at the left **3** in the lower area).
2. Select the function you wish to reuse and proceed with cooking as described in the previous sections.

Deleting the history

If you wish to delete the history:

1. Touch the HISTORY  button on the "main menu".
2. Touch the BASKET  button to delete the history.

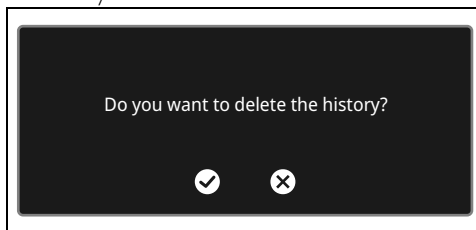

3. Touch the CONFIRM  button to confirm that you wish to delete the history (or the CANCEL  button to cancel the operation).

Mini guide to accessories



Rack

We recommend the use of the grill as a support surface for baking molds/casseroles.

In the absence of the baking tray grill, the grill can be used as a base for grilling with the deep baking tray placed on a shelf below to collect the juices.



Deep tray

We recommend the use of the deep baking tray for cooking on one level only.

Place the deep baking tray on the center shelf when using the fan-assisted functions. When

using the BAKE function,  place the deep baking tray on the required shelf.

Place the baking tray on the last shelf with the baking tray grill to cook in BROIL mode .



Tray rack

We recommend using the baking tray grill as a base for food to grill. The pan below collects the juices from the grills.

Discover the recipes

To consult the recipes developed for various categories of food and for more information on cooking suggestions, we recommend visiting the dedicated page on the www.smeg.com website, which can be reached using the QR code on the leaflet supplied with the product.

My recipes

This menu allows you to enter a personal program with the parameters you wish to use. On first use, the appliance will only offer you to add a new recipe. After saving your recipes, these will then be available in the relevant menu.

1. Touch the MY RECIPES  button on the "main menu" (at the left **3** in the lower area).

NOTES



- It is possible to store a limited number of personal recipes.
- It is not possible to memorize more than 17 recipes that belong to the same category.

Adding a recipe

2. Select the type of dish required from the MY RECIPES menu (for example "DESSERTS").
3. Touch the NEW RECIPE  button.
4. Select the required function.

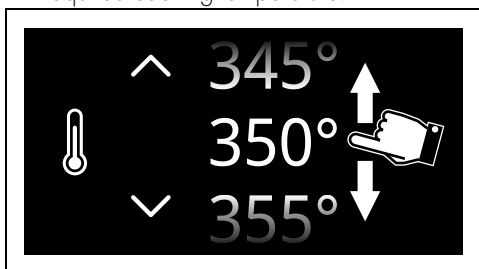
5. Touch the TEMPERATURE  button or the relevant value.
6. Scroll through the values and select the required cooking temperature.



7. Touch the CONFIRM  button to confirm the selected cooking temperature.
8. Touch the COOKING DURATION  button or the relevant value.
9. Scroll through the values and select the required duration.

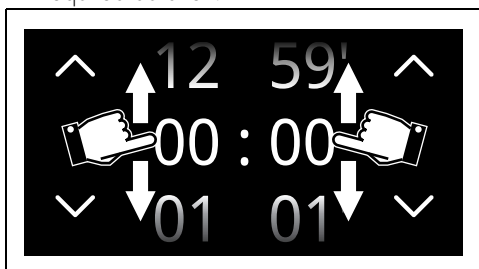

10. Touch the CONFIRM  button to confirm the selected cooking duration.

NOTES

- The minutes required for preheating are already included in the end-of-cooking time.
- At this point it is possible to add delayed cooking.

Saving a recipe

11. Touch the SAVE  button.
12. Scroll through the values to set the SHELF.

13. Scroll through the values to set the weight of the food to be cooked.

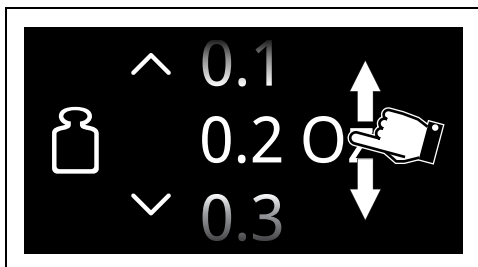



14. Touch the CONFIRM  button to confirm the settings.

At this point, a name for the recipe must be entered.

15. Use the alphanumeric keypad to enter the name of the recipe to be saved.

NOTES

- Use the  and  buttons to switch from the alphanumeric keypad to the numerical keypad and vice versa.
- The recipe name can contain a maximum of 12 characters, including spaces.
- The name must contain at least one character in order to store the recipe.
- The character  deletes the previous letter.
- To save a recipe, parameters must be set.

16. Touch the CONFIRM  button to store the program.

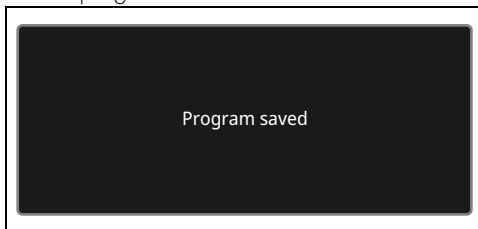

Starting a personal recipe

1. Touch the MY RECIPES  button on the "main menu".
2. Select the type of dish required from the MY RECIPES menu.
3. Select the recipe that was saved previously.

4. Touch the START  button to start cooking.

Pre-heating

Cooking is preceded by the pre-heating stage that allows the oven to heat up to the set cooking temperature.

This stage is indicated by a progressive increase in the temperature level reached.

This stage is indicated by a progressive increase in the temperature level reached.



After pre-heating, a buzzer will sound and a message will appear on the display to indicate that the food can be put in the oven.

The shelf on which the food should be placed in order to obtain best results is also indicated.

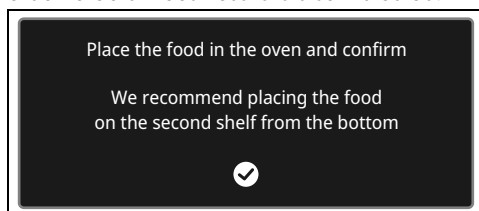

5. Open the door
6. Place the food inside the oven.
7. Close the door
8. Touch the CONFIRM  button to start cooking.

This stage is indicated by a progressive increase in cooking.



End of cooking

At the end of cooking, "Function ended" appears on the display and a buzzer sounds briefly.





- Touch the HOME  button to exit from the function.

Deleting a recipe

1. Touch the MY RECIPES  button on the "main menu".
2. Select the recipe that was saved previously.

3. Touch the DELETE  button to delete the recipe.



4. Touch the CONFIRM  button to confirm that you wish to delete the selected recipe (or the CANCEL  button to cancel the operation).

Other functions

The special functions menu includes several functions such as defrosting, proving or cleaning...

- Touch the OTHER FUNCTIONS  button on the "main menu" (in the main area **2**).



NOTES

- Certain functions are not available on all models.

DEFROST BY WEIGHT



Automatic defrosting function. Choose the dish, the oven calculates the time necessary for proper defrosting.



NOTES

- If the internal temperature is greater than the one required, the function will be stopped immediately and "Internal temperature unsafe, please wait until the oven is cool" will display. Allow the appliance to cool down before activating the function.
- It is not possible to change the default temperature for the Defrost by weight function.

1. Open the door.
2. After weighing the food, place it in the oven cavity.
3. Close the door.



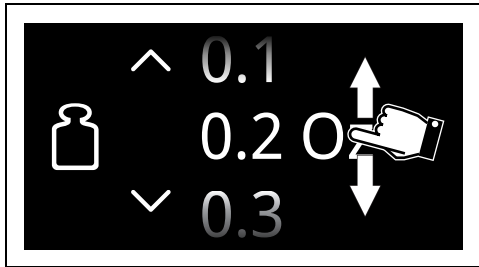

- Select DEFROST BY WEIGHT 
- Select the type of food to defrost from the categories MEAT - FISH - BREAD - DESSERTS
- Scroll through the values to set the weight of the food to be defrosted.



- Touch the CONFIRM  button to confirm the settings.
- Touch the START  button to start the defrost by weight function.

When finished, a buzzer sounds briefly.

Preset parameters:

Type	Weight (oz)	Time (minutes)
 Meats	17.5	18
 Fish	14	25
 Bread	10.5	5
 Desserts	35	5

NOTES

- Defrosting times may vary on the basis of the shape and size of the food to be defrosted.
- When defrosting heavy and/or irregularly shaped food (e.g. chicken, fish, etc.), it is advisable to turn it inside the oven cavity at least once by 180°.
- It is not possible to change the default temperature (90°F/ 30°C) for the Defrost by weight function

DEFROST BY TIME

-  Manual defrosting function. Select the length of time required for defrosting, when the set time has elapsed, the function will stop.

NOTES

- If the internal temperature is greater than the one required, the function will be stopped immediately and "Internal temperature unsafe, please wait until the oven is cool" will display. Allow the appliance to cool down before activating the function.
- The duration of the Defrost by time function can be from a minimum of 1 minute to a maximum of 12 hours and 59 minutes.
- It is not possible to change the default temperature (90°F/ 30°C) for the Defrost by time function.

- Open the door.
- Place the dish into the oven cavity.
- Close the door.

- Select DEFROST BY TIME 
- Touch the COOKING DURATION  button or the relevant value.
- Scroll through the values and select the required duration.

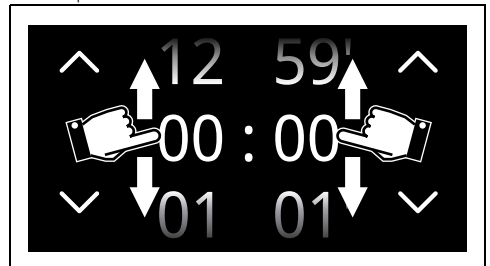

- Touch the CONFIRM  button to confirm the settings.
 - Touch the START  button to start the Defrost by time function.
- When finished, a buzzer sounds briefly.
- Touch the HOME  button to exit from the function.

PROOF



This function is particularly suitable for proving dough.

NOTES

- If the internal temperature is greater than the one required, the function will be stopped immediately and "Internal temperature unsafe, please wait until the oven is cool" will display. Allow the appliance to cool down before activating the function.
- For successful Proof, a container of water should be placed in the bottom of the oven.
- It is not possible to modify the default temperature of the Proof function (95°F/35°C)

1. Open the door
2. Position the dough to prove on the second level.
3. Close the door.

4. Select PROOF 
5. Touch the COOKING DURATION  button or the relevant value.

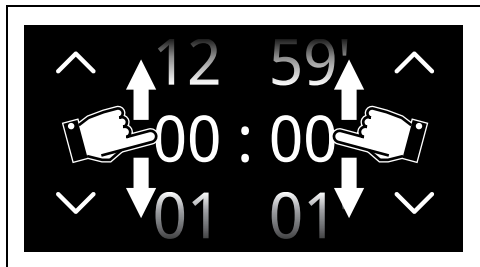

NOTES

- The duration of the Proof function can be from a minimum of 1 minute to a maximum of 12 hours and 59 minutes.
- It is possible to set the delayed function .



6. Touch the CONFIRM  button to confirm the settings.
 7. Touch the START  button to start the proving cycle.
- When finished, a buzzer sounds briefly.

PLATE WARMING



Function that heats and keeps plates warm. Position a baking tray on the lowest shelf and put the plates on it to warm.

1. Position the tray on the first shelf and place the plates to be warmed at the center of it.

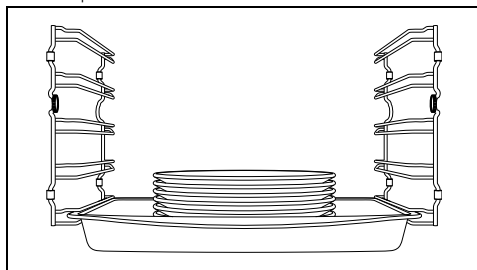



NOTES

- Do not stack plates too high. Stack plates a maximum of 5/6 high.
2. Select PLATE WARMING 
 3. Touch the START  button to start the Plate warming function.

NOTES

- Unless otherwise set, the Plate warming function has a maximum duration of 12 hours and 59 minutes.

The following can be set while the function is in operation:



- the temperature  (from 105°F/40°C to 180°F/80°C);
- the duration of the function ;
- a delayed function  (only if a duration different from the default one is set).

When finished, a buzzer sounds briefly.

KEEP WARM



This function allows you to keep pre-cooked foods warm.

1. Select KEEP WARM 
2. Touch the TEMPERATURE  button or the relevant value.

3. Scroll through the values and select the required cooking temperature (from 140°F/60°C to 210°F/100°C).
4. Touch the START  button to start the Keep warm function.

When finished, a buzzer sounds briefly.



STONE



Useful for on stone cooking. For use with the PPR2 or STONE accessory sold separately.



NOTES

- Please refer to the instructions and recommendations for use described in the accessory documentation.
1. Open the door.
 2. Insert the PPR2 or STONE accessory into the oven cavity (refer to the specific accessory manual).
 3. Close the door.
 4. Select STONE .
 5. Scroll through the values and select the required cooking temperature (from 395°F/200°C to 540°F/280°C).
 6. Touch the START  button to start the Stone function.



NOTES

- As with normal cooking functions, you can skip pre-heating and set a timed and delayed cooking.
7. After pre-heating, open the door and place the food to be cooked on the accessory.
 8. Close the door.

When finished, a buzzer sounds briefly.

BBQ (Barbecue)



Useful for barbecue cooking. For use with the BBQ accessory sold separately.





NOTES

- Please refer to the instructions and recommendations for use described in the accessory documentation.



NOTES

- The temperature probe can be used for the BBQ function (see chapter "Using the temperature probe").
1. Open the door.
 2. Insert the BBQ accessory into the oven cavity.
 3. Close the door.
 4. Select BBQ .
 5. Scroll through the values and select the required cooking temperature (from 140°F/60°C to 540°F/280°C).
 6. Touch the START  button to start the BBQ function.



NOTES

- As with normal cooking functions, you can skip pre-heating and set a timed and delayed cooking.
7. After pre-heating, open the door and place the food to be cooked on the accessory.
 8. Close the door.
- When finished, a buzzer sounds briefly.



AIRFRY



Useful to obtain fried cooking without oil. For use with the AIRFRY accessory sold separately.



NOTES

- Please refer to the instructions and recommendations for use described in the accessory documentation.
1. Select AIRFRY .
 2. Turn the temperature knob to select the required temperature (from 395°F/200°C to 540°F/280°C).
 3. Touch the START  button to start the AIRFRY function.



NOTES

- As with normal cooking functions, you can skip pre-heating and set a timed and delayed cooking.

- When preheating is complete, open the door and insert the AIRFRY accessory with the food to be cooked into the oven cavity.
- Close the door.

When finished, a buzzer sounds briefly.

SABBATH



Function that allows you to cook food whilst respecting the provisions of the Jewish day of rest.



NOTES

This function results in the appliance operating in a particular way:

- It is possible to set the duration of the Sabbath function.
- The duration of the Sabbath function can be from a minimum of 1 minute to a maximum of 73 hours and 59 minutes.
- No preheating will be performed.
- The cooking temperature that can be selected ranges from 140°F/60°C to 540°F/280°C.
- Oven light disabled, any operation such as opening the door or manual activation will not activate the light.
- The internal fan remains turned off.
- Buzzers disabled.



- Open the door.
- Place the dish into the oven cavity.
- Close the door.

- Select SABBATH

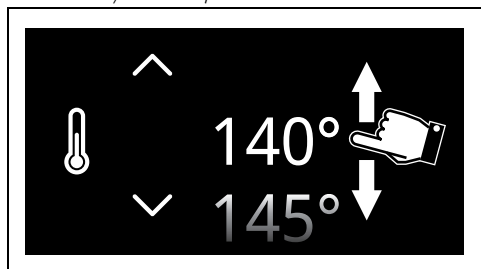

- Touch the TEMPERATURE button  or the relevant value.
- Scroll through the values and select the temperature (from 140°F/60°C to 540°F/280°C).



- Touch the CONFIRM button  to confirm the selected temperature.
- Touch the START button  to start the Sabbath function.

To stop the function:

- Touch the HOME button  for around 3 seconds.

Alternatively

- Touch the ON-OFF button  for approximately 3 seconds (the display reverts to the screen of the function).

In the event of a blackout

Following a power failure, the appliance automatically resumes the screen with the Sabbath function requirements. The cooking process is interrupted and cannot be restarted.

Manual water load



Function for filling water (or other liquids) into the reservoir.



NOTES

- Use cold tap water which is not too hard, softened water or still mineral water.
- Do not use distilled water, tap water with a high chloride content (> 40 mg/l), or other liquids.

- Fill the jug or a container with a sufficient amount of water for the functions that you wish to use.
- Open the oven door.
- Place the jug (or container) on the open door.



NOTES

- The jug or container with the water must have a gross weight lower than 5 kg.
- Do not place the jug (or container) on the glass of the door. Rest the jug on the opaque surface of the door at the tube.

- Touch the OTHER FUNCTIONS



button on the "main menu" (in the main area ).

5. Touch the WATER LOAD  button.

6. Remove the tube from its seat.

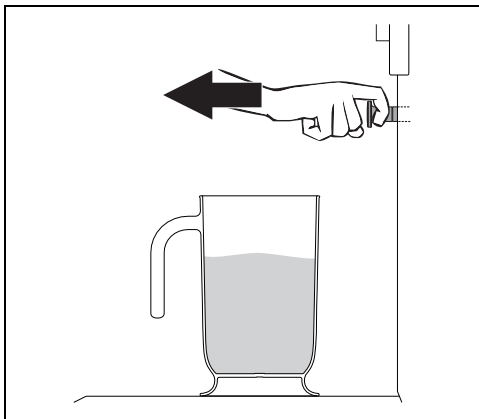

NOTES

- Pay attention to the distance to be kept so as not to be hit by the nozzle ejection.

7. Place the end of the tube at the bottom of the jug (or container).

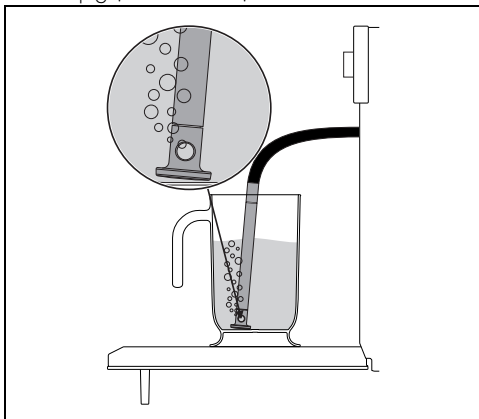

The display will show the screen for filling the water in the reservoir.

8. Press the START  button to start filling the appliance reservoir with water.

NOTES

- The appliance will automatically draw the quantity of water necessary for cooking on the basis of the set duration.

NOTES

- In the event that the water runs out, the appliance will automatically stop the cooking process, a buzzer will sound and the display will show a request to fill the reservoir with water.
9. When finished, shake the tube in order to remove any remaining water.

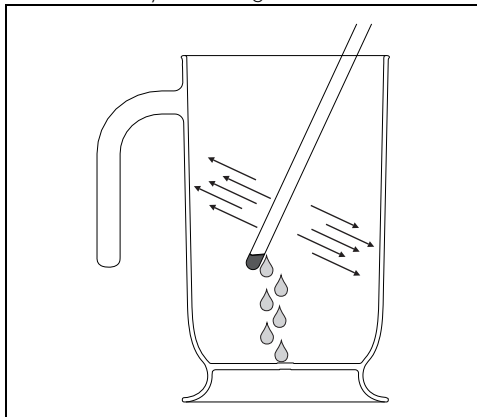

10. Place the tube into its seat.

11. Remove the jug (or container).

12. Close the door.

NOTES

- When the door is closed, a system will automatically draw in any residual water from the loading nozzle to avoid drips. A bubbling noise may be heard; this is completely normal.

13. Touch the CONFIRM  button to confirm that you have finished filling the reservoir.

NOTES

- Each time the door is opened, the function in progress will stop and then automatically restart when the door is closed again.

Manual water drain



Function for draining water (or other liquids) from the reservoir.

1. Touch the OTHER FUNCTIONS  button on the "main menu" (in the main area **2**).

2. Touch the WATER DRAIN  button.
3. Place a jug or a container on the open door.



NOTES

- Do not place the jug (or container) on the glass of the door. Rest the jug on the opaque surface of the door at the tube.
4. Remove the tube from its seat.

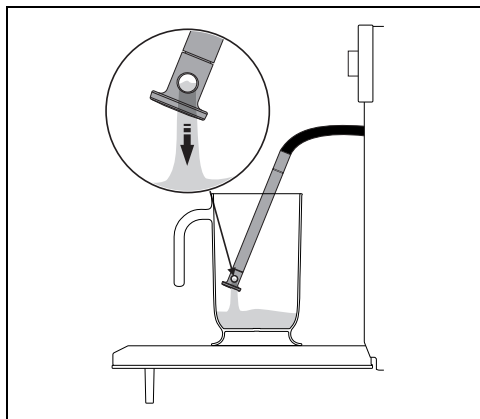

5. Press the START  button to start draining the water into the jug (or container).



NOTES

- It is only possible to drain the water when the door is open. Always make sure that you have removed the tube from its seat and inserted its end into the jug (or container) before pressing the START button  to start the draining cycle.

When complete, the display will indicate that the residual water removal process is complete.

6. Touch the CONFIRM  button.

7. Shake the tube in order to remove any remaining water.

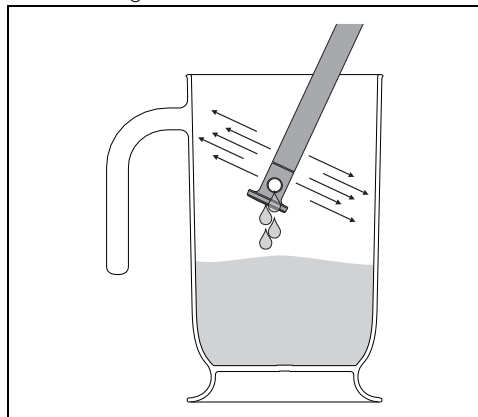

8. Place the tube into its seat.
9. Remove the jug (or container).
10. Close the door.

Settings



NOTES

- In the event of a temporary power cut, all personal settings will remain stored.

The product configuration can be set using this menu.

- Touch the SETTINGS  button on the "main menu" (at the right in the lower area **3**).

Language



NOTES

- Allows you to select the language of the display.

1. Select  Language.
2. Scroll through the available languages to select the required language.
3. Touch the CONFIRM  button to confirm the selected language.



Controls lock

NOTES

- Allows the appliance to automatically lock the controls after one minute of normal operation without any intervention from the user.

1. Select  Controls lock.
2. Select Yes.
3. Touch the CONFIRM  button to activate the Controls lock mode.

NOTES

- During normal operation, it is indicated by the  indicator light turning on in the information area .

To temporarily disable the lock during cooking:

4. Touch one of the values that you wish to modify.

A message displays that indicates how to temporarily disable the Controls lock mode.



Press the icon for 3 seconds
to deactivate the control lock





5. Touch the  icon for 3 seconds.

Show Room mode (for showrooms only)

NOTES

- This mode deactivates all the appliance's heating elements, while keeping the control panel active.
- During normal operation, it is indicated by the  indicator light turning on in the information area .
- To use the appliance normally, set this mode to Off.

1. Select  Show Room.
2. Select On.
3. Touch the CONFIRM  button to activate the Show Room mode.

Sound

NOTES

- Whenever one of the display symbols is pressed, the appliance beeps. This setting disables these sounds.

1. Select  Sound.
2. Select Off.
3. Touch the CONFIRM  button to disable the sound associated with the touching of the symbols on the display.

Keep warm



NOTES



- This mode allows the appliance to keep cooked food warm (at low temperatures) after cooking finishes with a cooking cycle for which a duration has been set (if this is not manually interrupted), without altering the taste and aromas obtained during cooking.
- The keep warm function will be activated 5 minutes after cooking has finished; this is indicated by a series of beeps (see cooking or function ended).
- The temperature of the keep warm function is set to 180°F/80°C.

1. Select  Keep warm.
2. Select On.
3. Touch the CONFIRM  button to activate the Keep warm mode.

Eco light

NOTES

- For greater energy savings, the lights inside the oven cavity are automatically deactivated approximately one minute after the start of cooking or after the door is opened.
- To stop the appliance from automatically deactivating the light after approximately one minute, set this mode to "Off".
- Manual on/off control is always available. Press the  symbol, when available, to manually activate the oven light or the  symbol to deactivate it.
- The Eco light function is factory set to "On".

1. Select  Eco light.
2. Select On.
3. Touch the CONFIRM  button to activate the Eco light mode.

Digital clock

NOTES

- Displays the current time in digital format.
- In the event of a temporary power cut, the digital version will remain activated.

1. Select  Digital clock.
 2. Select On.
- Touch the CONFIRM  button to activate the Digital clock mode.



Demo Mode (for showrooms only)

NOTES

- The same as Show Room, when this mode is activated, after a certain period of inactivity, a demonstration of the various screens that illustrate the potential of the appliance is shown on the display.
- To use the appliance normally, set this mode to Off.

1. Select  Demo Mode.
2. Select On.
3. Touch the CONFIRM  button to activate the Demo Mode.

Standby time

NOTES



- Turns on/off the clock display when the oven is off.
- The "Display time" function is factory set to Off.
- If the "Display Time" function is set to On, the standby appliance shows the current time in low brightness on the display.
- The "Display Time" function set to On results in higher power consumption of the appliance in standby.

1. Select  Display Time.
2. Select On.
3. Touch the CONFIRM button  to activate the time display.

Weight type

NOTES



- Allows the unit of measurement to be set to display the weight value in either ounces (oz) or kilograms (kg).
- The Weight type function is factory set to ounces.

1. Select  Weight type.
2. Select oz or kg.
3. Tap the CONFIRM button  to activate the desired weight measurement unit.

Clock format

NOTES



- Activates/deactivates the clock display in the 12 or 24 hour format.
- The Clock format function is factory set to 12 h.

1. Select  Clock format.
2. Select 12 h or 24 h.
3. Touch the CONFIRM  button to activate the required clock format.

Temperature format

NOTES



- Allows the temperature scale to be set in either degrees Fahrenheit (°F) or degrees Celsius (°C).
- The Temperature format function is factory set to °F.

1. Select  Temperature format.
2. Select °F or °C.
3. Touch the CONFIRM  button to activate the required temperature format.

Display brightness

NOTES

- This allows the display brightness level to be selected.
- The Display brightness function is factory set to High.

1. Select  Display brightness.
2. Select from the options High - Medium - Low.
3. Touch the CONFIRM  button to confirm the selection.

Restore settings

NOTES

- This restores all settings to the original factory settings.

4. Touch the FACTORY RESET  button on the "settings menu"  (at center in the lower area ).
5. Touch the CONFIRM  button to confirm the selection.

CLEANING AND MAINTENANCE

Cleaning the appliance

WARNING

Surface cleaning

To maintain the surfaces, you must clean them regularly after each use once they have cooled down.

Ordinary daily cleaning

Always use specific products only that do not contain abrasives or chlorine-based acids. Pour the product onto a damp cloth and wipe the surface, rinse thoroughly and dry with a soft cloth or a microfiber cloth.

Food stains or residues

Do not use steel sponges and sharp scrapers, as they will damage the surfaces.

Use normal, non-abrasive products and a wooden or plastic tool, if necessary. Rinse

thoroughly and dry with a soft cloth or a microfiber cloth.

Do not allow residues of sugary foods (such as jam) to set inside the oven. If left to set for too long, they might damage the enamel lining of the oven.

Cleaning the oven cavity

Proper maintenance of the oven's interior requires that it be cleaned regularly, after allowing it to cool.

Avoid leaving dried up food inside the oven because it could damage the enamel surface.

Before cleaning, take out all removable parts.

To make cleaning easier, we recommend the removal of:

- The door:

- the frame supports for racks/trays;.



NOTES

- If you are using specific cleaning products, we recommend operating the appliance at the maximum temperature for about 15-20 minutes to remove any residues.

Drying

Cooking food generates moisture inside the appliance. This is a normal phenomenon and does not affect the appliance's operation in any way.

Each time you finish cooking:

1. let the appliance cool down;
2. Remove any dirt from inside the appliance.
3. Dry the interior of the appliance with a soft cloth.
4. Leave the door open until the inside of the appliance has dried completely.

Removing racks/trays support frames

Removing the guide frames enables the sides to be cleaned more easily.

To remove the guide frames:

1. Unscrew the frame fastening pins:

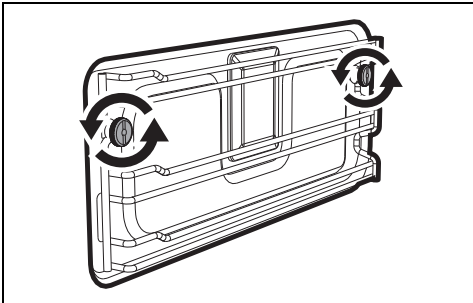

2. Pull the frame towards the inside of the oven to free it from the fastening pins.

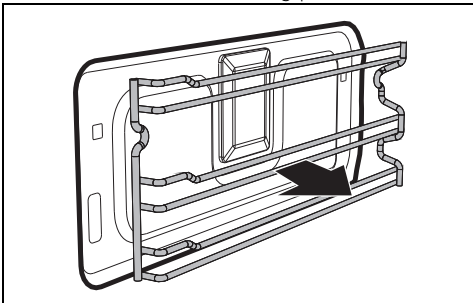

3. When cleaning is complete, repeat the above procedures to put the guide frames back in.

Cleaning the door

Removing the door

For easier cleaning it is recommended to remove the door and place it on a towel.

To remove the door proceed as follows:

1. Open the door completely and insert two pins into the holes on the hinges indicated in the figure.

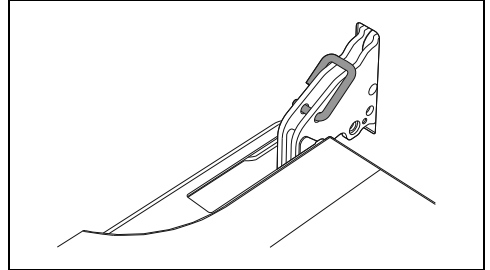

2. Grasp the door on both sides with both hands, lift it forming an angle of around 30° and remove it.

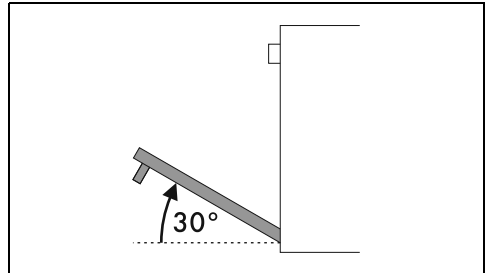

3. To reattach the door, insert the hinges into the slots on the oven, making sure that grooved sections **A** fit tightly in the slots.

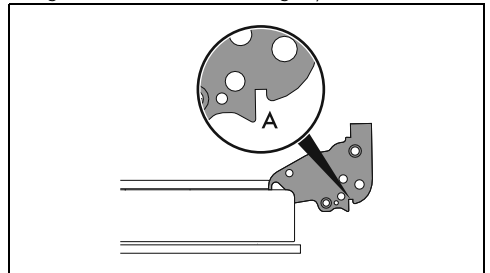

4. Lower the door and once it is in place remove the pins from the holes in the hinges.

Cleaning the door glazing

The glass in the door should always be kept thoroughly clean. Use absorbent paper towels. If there are tough to clean spots, use a damp sponge and regular detergent.

Vapor Clean

WARNING

NOTES

- The Vapor Clean function is an assisted cleaning procedure which facilitates the removal of dirt. Thanks to this process, it is possible to clean the inside of the oven very easily. The dirt residues are softened by the heat and water vapor for easier removal afterwards.

Preliminary operations

Before starting the Vapor Clean function:

- Remove all accessories inside the oven cavity.
- Remove any food residue inside the appliance.
- Perform the Vapor Clean function only when the appliance is cold.
- Remove the temperature probe (where fitted).
- Remove the self-cleaning panels (where fitted).
- During the assisted cleaning cycle, wash the self-cleaning panels (where fitted), which were previously removed, separately in warm water and a small amount of detergent.
- Pour approx. 4 fl. oz. (120 cc) of water onto the floor of the oven. Make sure it does not overflow out of the cavity.

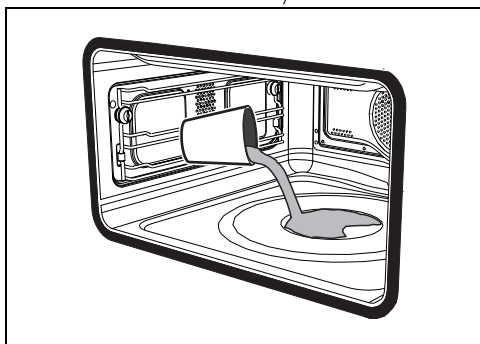

- Spray a water and mild liquid detergent inside the oven using a spray nozzle. Direct the spray against the side walls, upwards,

downwards and towards the deflector.

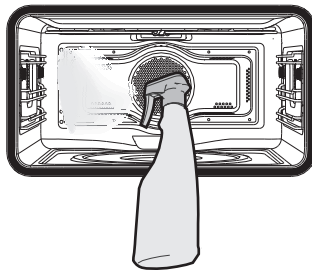

- Close the door.

NOTES

- We recommend spraying approx. 20 times at the most.

Vapor Clean cycle setting

NOTES

- If the indoor temperature is higher than expected, the function is not activated. Let the appliance cool down before activating the function.
- The duration and temperature of the Vapor Clean function cannot be changed by the user.
- It is possible to set the delayed function .

1. Touch the OTHER FUNCTIONS  button on the "main menu" (in the main area **2**).

2. Select VAPOR CLEAN .

3. Touch the START  button to start the Vapor Clean function.

End of Vapor Clean

At the end of the Vapor Clean function, "Function ended" is shown on the display and a buzzer sounds briefly.



1. Touch the HOME  button to exit from the function.

- Proceed with reservoir draining as described above.
- Open the door and wipe away the less stubborn dirt with a microfiber cloth.
- Use a non-scratch sponge with brass filaments on hard to remove deposits.
- In case of grease residues use specific oven cleaning products.
- Remove any remaining water from the oven cavity.
- Where fitted, reposition the self-cleaning panels and the rack/tray support frames.

For greater hygiene and to avoid foods taking on unpleasant odors:

- we recommend drying the inside of the oven with a fan-assisted function at 160°C for around 10 minutes.
- Where the self-cleaning panels are fitted, we recommend drying the oven cavity with a simultaneous catalytic cycle.

NOTES

- We recommend wearing rubber gloves for these operations.
- We recommend removing the door in order to make the manual cleaning of the parts that are difficult to reach easier.

Descaling

WARNING

- The presence of scale due to lack of descaling can compromise correct operation of the appliance in the long term.

NOTES

- Descaling is a long process (more than one hour) that requires the user to be present in front of the appliance.

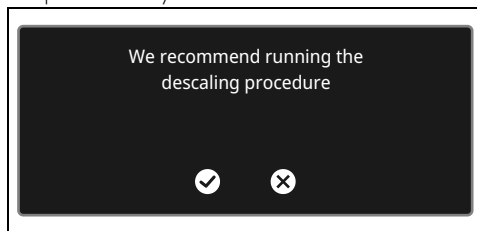

The following message will appear on the display from time to time to indicate that you should carry out the descaling of the

evaporation tray on the bottom of the oven.

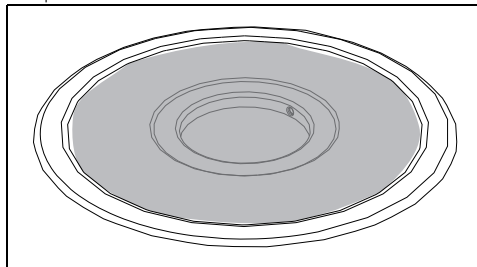

- Touch the CONFIRM  button to confirm.
- Open the door.
- Pour approximately 250 ml of white vinegar into the evaporation tray, thus also covering part of the base of the oven.



- Touch the START  button to start the descaling cycle.
- Touch the CONFIRM  button at the end of the descaling process to confirm.
- Remove the vinegar from the base of the oven with the supplied sponge.
- Use a dish sponge on softened encrustations in order to remove the largest possible quantity of scale.
- When you have finished cleaning, close the door again.

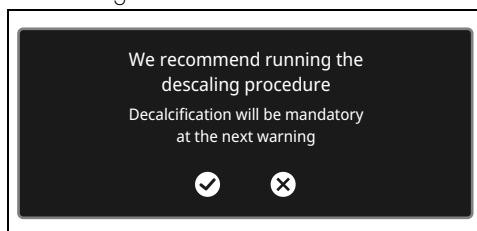

NOTES

- We recommend performing descaling every time this is indicated on the display in order to keep the boiler in perfect operating conditions.

NOTES

- After this, the appliance will not allow you to run any other function until the descaling process is performed.
- After this, the appliance will not allow you to run any other function until the descaling process is performed.

Manual descaling

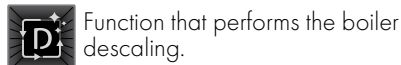

When you wish to perform descaling in advance, you can run the function manually:

1. Touch the OTHER FUNCTIONS  button on the "main menu" (in the main area **2**).

2. Touch the DESCALING  button.

Proceed with the descaling procedure as described in the previous paragraphs.

Manual tank clean

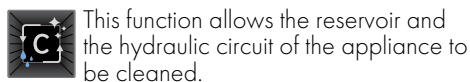

1. Touch the OTHER FUNCTIONS  button on the "main menu" (in the main area **2**).

2. Touch the TANK CLEAN  button.

Preliminary operations

1. Fill a jug or container with about 2 liters of clean water.
2. Open the oven door.
3. Place the jug (or container) on the open door.

NOTES

- The jug or container with the water must have a gross weight lower than 5 kg.
- Do not place the jug (or container) on the glass of the door. Rest the jug on the opaque surface of the door at the tube.

4. Extract the tube from its seat and immerse its end in the jug (or container) until it reaches the bottom.

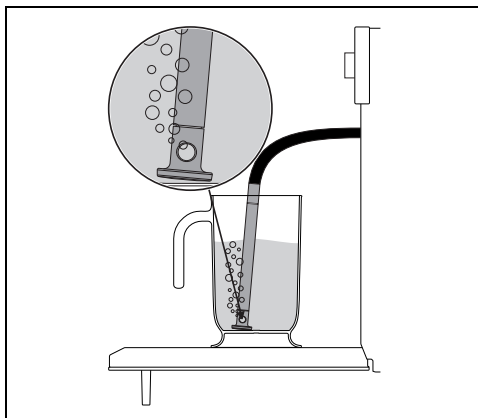

5. Press the START  button to start filling the appliance reservoir with water.

NOTES

- The appliance will automatically draw sufficient water to fill the reservoir.

6. Touch the CONFIRM  button to confirm that you have finished filling the reservoir. The display will show the time left until the end of the cleaning cycle.

When the cleaning process is complete, a buzzer will sound and the display will show the draining screen.

7. Open the oven door.
8. Place the jug provided or a container on the open door.
9. Remove the tube from its seat and insert the end of it into the jug (or container).

Extraordinary maintenance

Replacing the oven light

WARNING

- Unplug the appliance.
- Wear protective gloves.

1. Remove all accessories inside the oven.
2. Remove the frame supports for racks/trays.
3. Use a tool (e.g. a spoon) to remove the bulb cover.

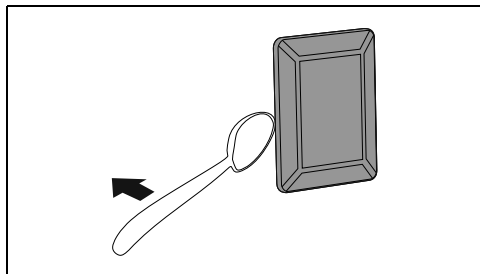

4. Loosen and remove the light bulb.

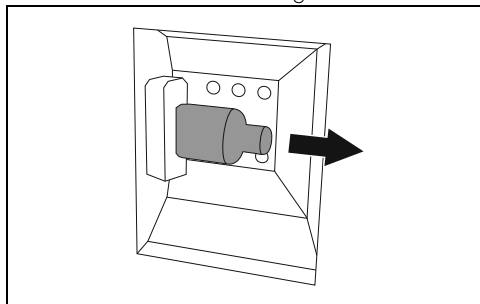

NOTES

- Be careful not to scratch the enamel of the oven walls.

5. Replace the bulb with a similar one (40 W).

NOTES

- Do not touch the halogen bulb with your fingers; cover them with an insulating cloth.

10. Press the **START**  button to start draining the water into the jug (or container).

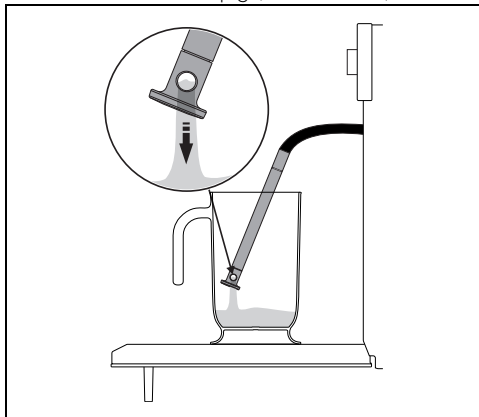

When complete, the display will indicate that the residual water removal process is complete.

NOTES

- We recommend carrying out the reservoir cleaning process every 2-3 months

11. Touch the **CONFIRM**  button to confirm that you have finished cleaning the reservoir.
12. Shake the tube in order to remove any remaining water.

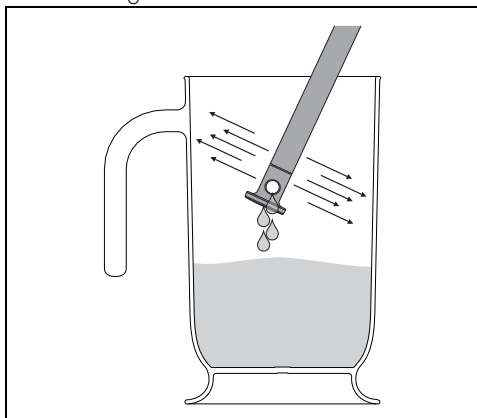

13. Shake the loading nozzle to remove any remaining water.
14. Place the tube into its seat.
15. Remove the jug (or container).
16. Drain the water from the jug.
17. Close the door.

6. Reattach the cover. Ensure the molded part of the glass (A) is facing the door.

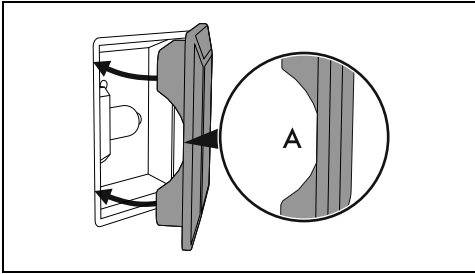

7. Press the cover firmly so that it adheres tightly to the light bulb holder.

Seal maintenance tips

The seal should be soft and elastic.

- To keep the seal clean, use a non-abrasive sponge and wash with lukewarm water.

What to do if...

The display is completely off:

- Check the mains power supply.
- Check if any circuit breakers upstream of the appliance supply line are in the "ON" position.

The appliance does not heat up:

- Check whether "Show Room (for showrooms only)" or "Demo Mode (for showrooms only)" has been set (for further details see "settings" section).

The controls do not respond:

- Check whether the "Controls lock" mode has been set (for further details see "settings" section).