

SPR30UGMX

Range size	30"
Cooktop type	Gas
Main oven	Thermo-ventilated
EAN code	8017709316570



Aesthetic











Series	Professional	Grates	Cast Iron
Color	Stainless steel	Control setting type	Control knobs
Finishing	Satin	Control knobs	Pro-style control knobs
Control panel finish	Stainless steel	Controls color	Stainless steel
Logo	Assembled	Silkscreen color	Black
Logo position	Fascia below the oven	Handle	Robust knurled handle
Cooktop color	Black enamel	Handle color	Brushed stainless steel

Programs / Functions

No. of cooking functions 8

Traditional cooking functions

 Static	 Fan-assisted	 True European convection
 Small grill	 Large grill	 Large grill + Fan
 Convection bottom	 Pizza	

Other functions

 Defrost by time
--

Cleaning functions



Cooktop technical features

Cooking zones 4

Front-left - 3500 W - 12000 BTU

Rear-left - 2900 W - 10000 BTU

Rear-right - 2900 W - 10000 BTU

Front-right - 5300 W - 18000 BTU

Main Oven Technical Features



No. of lights	2	Removable inner door	Yes
Fan number	1	Total no. of door glasses	3
Volume	4.56 cu. ft.	Cooling system	Tangential
Cavity material	EverClean enamel	Bottom heating element - Power	1700 W
No. of shelves	6	Upper heating element - Power	1200 W
Shelves type	Metal racks	Grill power	1700 W
Light type	Halogen	Large grill - Power	2900 W
Light Power	40 W	Circular heating element - Power	2700 W
Time setting	Minute minder	Grill type	Electric
Removable door	Yes	Soft Close system	Yes
Full-glass inner door	Yes		

Main oven options

Minimum Temperature	149 °F	Maximum temperature	500 °F
----------------------------	--------	----------------------------	--------

Accessories included for main oven and cooktop

Oven wire rack	2	Meat Probe	1
-----------------------	---	-------------------	---

Electrical Connection

Plug	(B) NEMA 14-50P	Type of electric cable installed	Yes, Double phase
Electrical connection rating	3900 W	Power cord length	47 1/4 "
Current	16 A	Frequency	60 Hz
Circuit breaker	20 A	Terminal block	3 pins
Voltage	208/240 V		

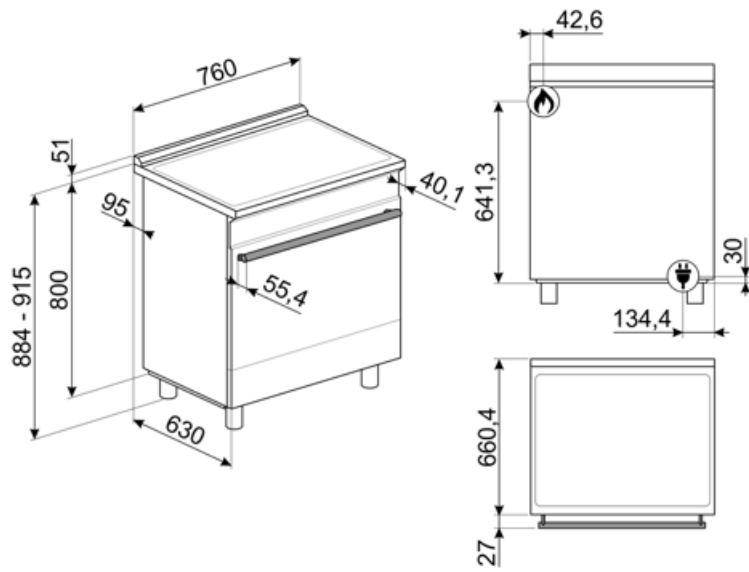

Not included accessories



GRM

Gas hobs moka support



SFLK1

Child lock





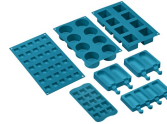















GT3T



SMOLD

Set of 7 silicone moulds for ice creams, ice lollies, pralines, ice cubes or to portion food. Usable from -60°C to +230°C

Symbols glossary (TT)

 <p>Heavy duty cast iron pan stands: for maximum stability and strength.</p>	 <p>Installation in column: Installation in column</p>
 <p>Air cooling system: to ensure a safe surface temperatures.</p>	 <p>Defrost by time: with this function the time of thawing of foods are determined automatically.</p>
 <p>Triple glazed doors: Number of glazed doors.</p>	 <p>Enamel interior: The enamel interior of all Smeg ovens have a special antacid lining which helps keep the interior clean by reducing the amount of cooking grease adhering to it.</p>
 <p>Circogas: In gas ovens the fan distributes the heat quickly and evenly throughout the oven cavity, avoiding flavour transfer when cooking a number of different dishes at the same time. In electric ovens this combination completes cooking more quickly of foods that are ready on the surface, but that require more cooking inside, without further browning.</p>	 <p>Fan with upper and lower elements: The elements combined with the fan aim to provide more uniform heat, a similar method to conventional cooking, so pre-heat is required. Most suitable for items requiring slow cooking methods.</p>
 <p>Upper and lower element only: a traditional cooking method best suited for single items located in the centre of the oven. the top pf the oven will always be hottest. Ideal for roast, fruit cakes, bread etc.</p>	 <p>True European Convection: The combination of the fan and circular heating element around it provides many benefits, including no preheat if cooking time is longer than 20 minutes, no flavor transfer when cooking different foods at the same time, lower energy consumption, and shorter cooking times. Suitable for all types of food preparations.</p>
 <p>Grill element: Using of grill gives excellent results when cooking meat of medium and small portions, especially when combined with a rotisserie (where possible). Also ideal for cooking sausages and bacon.</p>	 <p>Half grill: For rapid cooking and browning of foods. Best results can be obtained by using the top shelf for small items, the lower shelves for larger ones, such as chops or sausages. For half grill heat is generated only at the centre of the element, so is ideal for smaller quantities.</p>
 <p>Fan with grill element: The fan reduces the fierce heat from the grill, providing an excellent method of grilling various foods, chops, steaks, sausages etc. giving even browning and heat distribution, without drying out the food. The top two levels recommended for use, and the lower part of the oven can be used to keep items warm at the same time, an excellent facility when cooking a grilled breakfast. Half grill (centre portion only) is ideal for small quantities of food.</p>	 <p>Pizza function: The simultaneous operation of three elements ensures an optimum cooking facility when used with the Smeg pizza stone.</p>
 <p>Gas ovens offer instantaneous heat control, reduced cooking times and the ability to bake at much lower temperatures than electric ovens.</p>	 <p>All glass inner door: All glass inner door, a single flat surface which is simple to keep clean.</p>
 <p>The inner door glass: can be removed with a few quick movements for cleaning.</p>	 <p>Side lights: Two opposing side lights increase visibility inside the oven.</p>



The oven cavity has 6 different cooking levels.



Soft close: all models are equipped with advanced function of smooth closing of the door, which allows the device to close smoothly and quietly.



Vapor Clean: a simple cleaning function using steam to loosen deposits in the oven cavity.



Knobs control

Benefit (TT)

True-convection

The best cooking performances guaranteed by ventilated circular flow.

Multiple fans and heating elements guarantee the perfect aerodynamic heat flow, allowing homogeneous and quicker cooking inside the cavity.

Gas hob

Induction offers fast cooking and precise temperature control

Equipped with a thermocouple, the gas supply is cut off if the flame is extinguished for greater safety

Touch control

Easy and intuitive timer setting with a single touch

Single turbine

The oven has a fan equipped with a circular heating element allowing cooking with rotating heat

Isothermic Cavity

The best cooking performance at the highest energy efficiency

Tangential cooling

New cooling system with tangential fan and airflow from the door to the splashback

Soft close

The door is equipped with a specific system for silent closing

Multilevel halogen light

Internal halogen lighting on different levels guarantees excellent visibility

Adjustable height

Cooker top flushed with the working area thanks to adjustable feet

Removable inner glass

Internal door glasses are easily removable for complete cleaning

Multilevel cooking

Several cooking levels allow maximum flexibility of use

Cold door

During any function, the external door glass is cold, avoiding any risk of burns

AirFry (AIRFRY optional accessory)

Lighter and tastier food thanks to airfry basket

BBQ (optional accessory)

Barbeque cooking directly in the oven with the double-sided grill

Pizza stone (optional accessory)

Baking with refractory stone for soft and crispy pizza and yeast products (STONE optional accessory)