

STU8212



Product family	Dishwashers
Width	24"
Commercial height	82 cm
Installation	Fully-integrated built-in
N° baskets	2
EAN code	8017709303693



Programs



Number of programs	5	Delicates	Yes
Washing temperatures	45, 50, 65, 70 °F	Normal	Yes
Mix	Yes	Pots & Pans	Yes
Daily (half load)	Yes		

Options



Delay start	3-6-9 hours	Extra-dry option	Yes
-------------	-------------	------------------	-----

Baskets

Basket color	Gray	Lower basket	Fixed racks
Upper basket	Central fixed racks	Largest loadable dish in lower basket	35,0 inches
Upper basket height adjustment	On two height levels	Colour Inner Components	Blue
Largest loadable dish in upper basket	25,0 inches	Cutlery basket	13 place settings

Technical Features



Width	23 9/16 "	Tube material	Stainless steel
-------	-----------	---------------	-----------------

Depth	21 7/16 "	Filter	Stainless steel
Height	32 3/16 "	Concealed heating element	Yes
Rinse aid indicator	Light	Hinges	Self-balancing with fixed hinges
End-of-cycle indicator	Acoustic signal	Min. and max. frontal panel weight	4.4 - 19.8 lbs
Washing system	Standard	Min. and max plinth height	4" - 9"
Third spray arm	Single	Adjustable feet	2 3/4", from 32 1/4" to 35"
Flood protection system	Single Aquastop	Additional gaskets	Yes
Max water hardness	100°FH;58°dH	Back cover	Yes
Drying system	Natural condensation drying		

Electrical Connection

Plug	(A) USA & Mexico	Frequency (Hz)	60 Hz
Connected power	1800 W	Connection type	Single-phase
Current	13 A	Power supply cable length	140 "
Voltage	115 V		

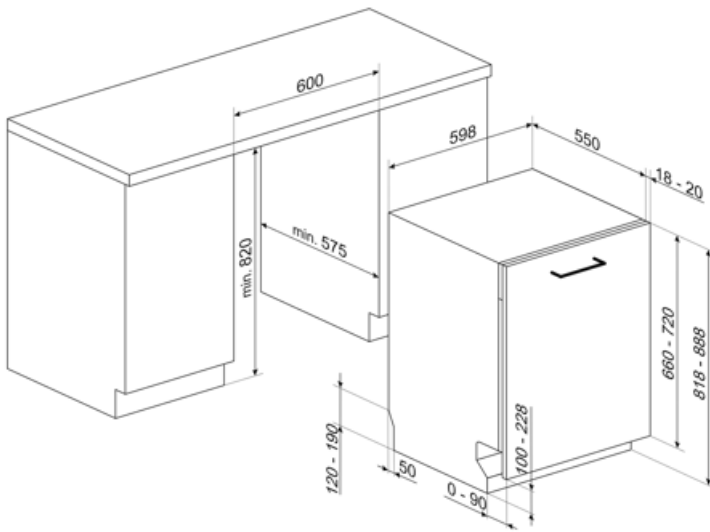

Not included accessories



KIT6CX

Classic aesthetics stainless steel panel with 14 mm. handle. Can be fitted on the fully integrated dishwashers.



KIT82CAN

Classic aesthetics anthracite panel with 14 mm. handle. Can be fitted on the fully integrated dishwashers.



KIT82CX



KITPL60FABB

Toekick Kit in White colour with adjustable height. Can be fitted over all the fully integrated and underbench models with Fixed Fulcrum. Can be installed also on the models with variable fulcrum or flexifit hinges.



KITPL60FABN

Toekick Kit in Black colour with adjustable height. Can be fitted over all the fully integrated and underbench models with Fixed Fulcrum. Can be installed also on the models with variable fulcrum or flexifit hinges.



KITPL60FABX











Toekick Kit in Stainless Steel with adjustable height. Can be fitted over all the fully integrated and underbench models with Fixed Fulcrum. Can be installed also on the models with variable fulcrum or flexifit hinges.



KITPLV2

Kit extension for dishwasher and washing machine: length mt. 2

Symbols glossary (TT)

	<p>Acquastop: Some Smeg dishwashers are equipped with a simple Acquastop: float sensor in the bottom which is necessary to prevent an accidental leakage of water inside the appliance.</p>		<p>COMM_HEIGHT_82_72dpi</p>
	<p>Delay Timer: The delay timer can postpone the start of the program by up to 24 hours.</p>		<p>Noise Level: Excellent insulation and special devices keep noise to a minimum.</p>
	<p>1/2 load: This program is designed for washing dishes not heavily soiled with partial load of the dishwasher.</p>		<p>Delicate: Delicate washing program is designed for delicate dishes which are not heavily soiled.</p>
	<p>Normal programme: The normal programme is suitable for normal degrees of dirt for everyday use.</p>		<p>The symbols show the number of plate settings of the dishwasher.</p>
	<p>System WaterSave ensures the best washing results with minimal water consumption depending on the model of dishwasher.</p>		<p>...</p>