

# STU8623X



<b>Product family</b>	Dishwashers
<b>Width</b>	24"
<b>Commercial height</b>	86 cm
<b>Installation</b>	Under counter built-in
<b>N° baskets</b>	3, FlexiDuo
<b>EAN code</b>	8017709303679



## Programs



<b>Number of programs</b>	10	<b>Delicates</b>	Yes
<b>Washing temperatures</b>	38, 45, 50, 55, 65, 70, 75 °F	<b>Normal</b>	Yes
<b>Soak</b>	Yes	<b>Crystal &amp; China</b>	Yes
<b>Express 27'</b>	Yes	<b>Eco express</b>	Yes
<b>Mix</b>	Yes	<b>Express 60'</b>	Yes
<b>Sterilize</b>	Yes	<b>Pots &amp; Pans</b>	Yes

## Options



<b>Dry Assist option</b>	Yes	<b>FlexiZone half-load option</b>	Yes
<b>Delay start</b>	Up to 24 hours	<b>Special programs option</b>	Yes

## Baskets



<b>Basket color</b>	Gray	<b>Largest loadable dish in upper basket</b>	18,0 inches
<b>Upper basket</b>	1 foldable rack	<b>Lower basket</b>	With 2 foldable racks
<b>Glass holder</b>	Yes	<b>Largest loadable dish in lower basket</b>	35,0 inches
<b>Upper basket height adjustment</b>	On 3 levels	<b>Colour Inner Components</b>	Blue
<b>Sliding Guides Extra Glide</b>	Yes		

Cutlery basket Yes

## Technical Features



<b>Width</b>	23 9/16 "	<b>Max water hardness</b>	100°FH;58°dH
<b>Depth</b>	21 5/8 "	<b>Drying system</b>	Natural condenser drying, with Dry Assist automatic door opening system at the end of the cycle
<b>Display type</b>	LED display (3 digits)	<b>Tub material</b>	Stainless steel
<b>Height</b>	33 3/4 "	<b>Filter</b>	Stainless steel
<b>Display</b>	Delay start, Program progress indicator, Time-to-end indicator	<b>Hinges</b>	Self-balancing with variable hinges
<b>Program symbols</b>	Symbols	<b>Min. and max. frontal panel weight</b>	4.4 - 17.6 lbs
<b>Salt indicator</b>	Light	<b>Min. and max plinth height</b>	4" - 9"
<b>Rinse aid indicator</b>	Light	<b>Adjustable feet</b>	2 3/4", from 33 7/8" to 36 5/8"
<b>End-of-cycle indicator</b>	Acoustic signal	<b>Additional gaskets</b>	Yes
<b>Washing system</b>	Orbital	<b>Back cover</b>	Yes
<b>Third spray arm</b>	Single	<b>Depth of dishwasher with open door (mm)</b>	1186
<b>Water softener</b>	With electronic setting	<b>Adjustable plinth</b>	By height and depth
<b>Flood protection system</b>	Single Aquastop	<b>Top cover</b>	Metal sheet

## Electrical Connection

<b>Plug</b>	(A) USA & Mexico	<b>Frequency (Hz)</b>	60 Hz
<b>Connected power</b>	1800 W	<b>Connection type</b>	Single-phase
<b>Current</b>	13 A	<b>Power supply cable length</b>	140 "
<b>Voltage</b>	115 V		

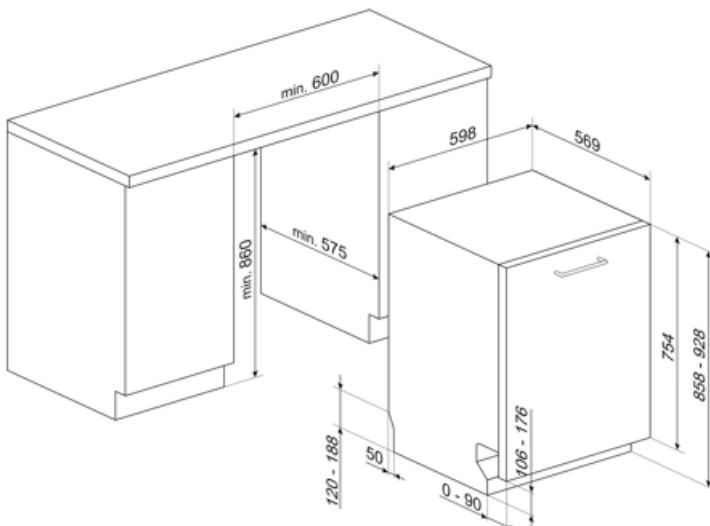

---

## Not included accessories

---

### KITGH

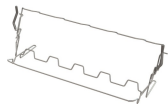

Kit glass holder. It has to be fitted on the first basket but only if there are foldable racks

### KITPL60N



Toekick Kit in Black colour with adjustable height and deepness. Can be installed over all the fully integrated and underbench models with variable fulcrum or flexifit hinges.

### KITPLV2



Kit extension for dishwasher and washing machine: lenght mt. 2

### KITPL60B







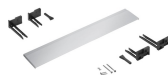











Toekick Kit in White colour with adjustable height and deepness. Can be installed over all the fully integrated and underbench models with variable fulcrum or flexifit hinges.

### KITPL60X



Toekick Kit in Stainless Steel with adjustable height and deepness. Can be fitted over all the fully integrated and underbench models with variable fulcrum or flexifit hinges.

## Symbols glossary (TT)

	Acquastop: Some Smeg dishwashers are equipped with a simple Acquastop: float sensor in the bottom which is necessary to prevent an accidental leakage of water inside the appliance.		COMM_HEIGHT_86_72dpi
	Delay Timer: The delay timer can postpone the start of the program by up to 24 hours.		Enersave: At the end of the drying cycle a special device slowly automatically opens the door a few centimeters, to ensure perfect drying and to save up to 20% of energy on some models.
	FlexiDuo: The FlexiDuo 3rd cutlery basket allows you to arrange cutlery or small cups, ladles, or bulky utensils however you like: it consists of two separate and moveable modules.		FlexiZone: The ½ load flexizone allows you to wash a reduced load saving energy, water and time and there are no restrictions on where the items are placed.
	The new ExtraGlide guide system, available on top of the range models, makes the second basket even smoother and softer. In fact, it facilitates the extraction of the introduction, even at full load and, for the greater excursion, the insertion of crockery is also facilitated in the rear part.		Noise Level: Excellent insulation and special devices keep noise to a minimum.
	Orbital wash system distributes water evenly throughout the 60cm dishwasher cavity, directing water with precision to ensure an excellent wash.		Delicate: Delicate washing program is designed for delicate dishes which are not heavily soiled.
	Normal programme: The normal programme is suitable for normal degrees of dirt for everyday use.		Soak programme: The soak programme provides a rinse to prevent dirt from drying.
	Rapid 27 Mins: The rapid 27 mins quick program takes just 27 minutes to wash a load.		The symbols show the number of plate settings of the dishwasher.
	...		...