

User's Guide

for Topload Washers

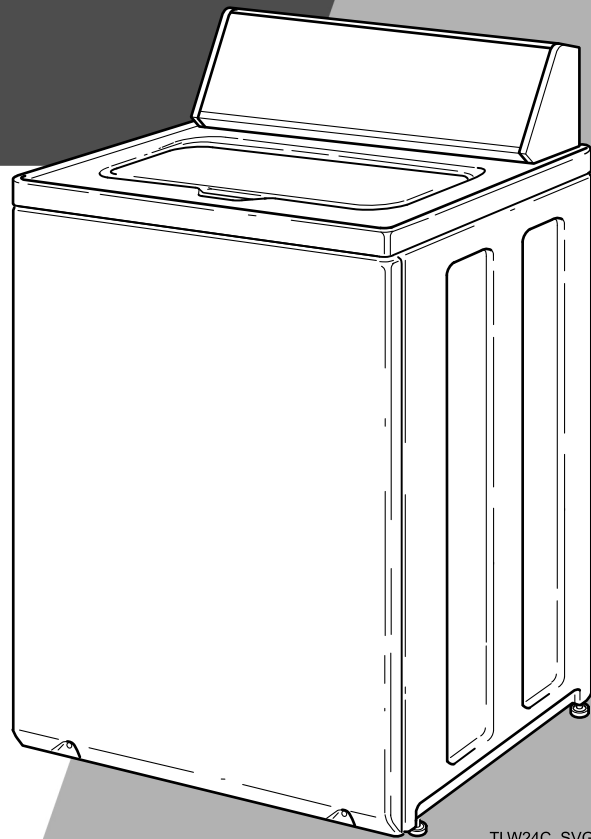

TLW24C_SVG1

Original Instructions

Keep These Instructions for Future Reference.

CAUTION: Read the instructions before using the machine.

(If this machine changes ownership, this manual must accompany machine.)

	WARNING
Failure to install, maintain, and/or operate this machine according to the manufacturer's instructions may result in conditions which can produce bodily injury and/or property damage.	
W030	

	WARNING
For your safety and to reduce the risk of fire or an explosion, do not store or use gasoline or other flammable vapors and liquids in the vicinity of this or any other appliance.	
W022	

NOTE: The WARNING and IMPORTANT instructions appearing in this manual are not meant to cover all possible conditions and situations that may occur. It must be understood that common sense, caution, and carefulness are factors which cannot be built into these washers. These factors **MUST BE** supplied by the person(s) installing, maintaining, or operating the unit.

Always contact the distributor, service agent, or the manufacturer about any problems or conditions you do not understand.



Read all instructions before using unit.

This product uses FreeRTOS V7.2.0 (www.freertos.org).

Register Your Product

Welcome to the Speed Queen family.

Thank you for your support of our truly commercial quality products. Please take a moment to register your product.

Benefits of registering your product:

- Provides verification of ownership
- Receive product notifications
- Simplifies warranty service, if needed
- Grants access to leave a product review
- Opt-in for latest offers and promotions

It's quick and easy to register.

Simply go to:

<https://speedqueen.com/support/register-your-products/>

Or scan:





Safety Information

Explanation of Safety Instruction Messages

Precautionary statements (“DANGER,” “WARNING,” and “CAUTION”), followed by specific instructions, are found in this manual and on machine decals. These precautions are intended for the personal safety of the operator, user, servicer, and those maintaining the machine.

	DANGER
Indicates an imminently hazardous situation that, if not avoided, will cause severe personal injury or death.	

	WARNING
Indicates a hazardous situation that, if not avoided, could cause severe personal injury or death.	

	CAUTION
Indicates a hazardous situation that, if not avoided, may cause minor or moderate personal injury or property damage.	

Additional precautionary statements (“IMPORTANT” and “NOTE”) are followed by specific instructions.

IMPORTANT: The word “IMPORTANT” is used to inform the reader of specific procedures where minor machine damage will occur if the procedure is not followed.

NOTE: The word “NOTE” is used to communicate installation, operation, maintenance or servicing information that is important but not hazard related.

Important Safety Instructions

Save These Instructions

	WARNING
To reduce the risk of fire, electric shock, serious injury or death to persons when using your washer, follow these basic precautions:	
W023	

- Read all instructions before using the washer.
- Install the washer according to the INSTALLATION INSTRUCTIONS. Refer to the EARTH/GROUND INSTRUCTIONS in the INSTALLATION manual for the proper earth/ground connection of the washer. All connections for water, drain, electrical power and earth/ground must comply with local codes and be made by licensed personnel when required. Do not do it yourself.
- Do not install or store the washer where it will be exposed to water and/or weather.
- Do not add the following substances or textiles containing traces of the following substances to the wash water: gasoline, kerosene, waxes, cooking oils, vegetable oils, machine oils, dry-cleaning solvents, flammable chemicals, thinners or other flammable or explosive substances. These substances give off vapors that could ignite, explode or cause the fabric to catch on fire by itself.
- Under certain conditions, hydrogen gas may be produced in a hot water system that has not been used for two weeks or more. HYDROGEN GAS IS EXPLOSIVE. If the hot water system has not been used for such a period, before using a washing machine or combination washer-dryer, turn on all hot water faucets and let the water flow from each for several minutes. This will release any accumulated hydrogen gas. THE GAS IS FLAMMABLE, DO NOT SMOKE OR USE AN OPEN FLAME DURING THIS TIME.
- To reduce the risk of an electric shock or fire, DO NOT use an extension cord or an adapter to connect the washer to the electrical power source.
- Do not allow children to play on or in the washer. Close supervision of children is necessary when the washer is used near children. This appliance is not intended for use by persons (including children) with reduced physical, sensory or mental capabilities, or lack of experience and knowledge, unless they have been given supervision or instruction concerning the use of the appliance by a person responsible for their safety. This is a safety rule for all appliances.
- Cleaning and user maintenance shall not be made by children without supervision.

- Children less than three years should be kept away unless continuously supervised.
- Do not reach into the washer if the washtub or agitator, if applicable, is moving.
- Never operate the washer with any guards, panels and/or parts removed or broken. DO NOT tamper with the controls or bypass any safety devices.
- Use your washer only for its intended purpose, washing clothes. Always follow the fabric care instructions supplied by the garment manufacturer.
- Always read and follow manufacturer's instructions on packages of laundry and cleaning aids. To reduce the risk of poisoning or chemical burns, keep them out of the reach of children at all times (preferably in a locked cabinet). Heed all warnings or precautions.
- Do not use fabric softeners or products to eliminate static unless recommended by the manufacturer of the fabric softener or product.
- Lid MUST BE CLOSED any time the washer is in operation. DO NOT bypass the lid switch or lid lock to permit the washer to operate with the lid open.
- Be sure water connections have a shut-off valve and that fill hose connections are tight. CLOSE the shut-off valves at the end of each wash day.
- Keep your washer in good condition. Bumping or dropping the washer can damage safety features. If this occurs, have your washer checked by a qualified service person.
- Do not repair or replace any part of the washer, or attempt any servicing unless specifically recommended in the user-maintenance instructions or in published user-repair instructions that you understand and have the skills to carry out. ALWAYS disconnect the washer from electrical supply before attempting any service.
- Disconnect the power cord by grasping the plug, not the cord. If the supply cord is damaged, it must be replaced by the manufacturer, its service agent or similarly qualified persons in order to avoid a hazard.
- Before the washer is removed from service or discarded, remove the lid or door to the washing compartment.
- Failure to install, maintain, and/or operate this washer according to the manufacturer's instructions may result in conditions which can produce bodily injury and/or property damage.

NOTE: The WARNING and IMPORTANT SAFETY INSTRUCTIONS appearing in this manual are not meant to cover all possible conditions and situations that may occur. Observe and be aware of other labels and precautions that are located on the machine. They are intended to provide instruction for safe use of the machine. Common sense, caution and care must be exercised when installing, maintaining, or operating the washer.

Always contact your dealer, distributor, service agent or the manufacturer about any problems or conditions you do not understand.

Table of Contents

- Operation 8**
 - Before Washing.....8
 - Loading the Washer.....8

- Control Panel 11**
 - Determine Proper Cycle11
 - Heavy Soil.....12
 - Status12
 - Audio Signals12
 - To Wash Clothes12
 - Pausing the Cycle13
 - Canceling the Cycle13

- Cycle Operation 14**
 - Common Washer Sounds16
 - Optional Features16

- Clothing Care 18**
 - Clothing Concerns.....18

- Maintenance 20**
 - Cold Weather Care.....20
 - Care of Your Washer.....20
 - Replacing Hoses20
 - Filter Screens20
 - Vacations and Extended Non-Use20
 - Preventative Maintenance21
 - Reinstallation of Shipping Materials21

- Troubleshooting 22**
 - Warranty Repairs26
 - Contact Information.....26

© Copyright 2024, Alliance Laundry Systems LLC
 All rights reserved. No part of the contents of this book may be reproduced or transmitted in any form or by any means without the expressed written consent of the publisher.

Operation

Before Washing

Prepare Wash Load

Empty Pockets and Cuffs

Make sure all pockets are empty and turn them inside out. One bobby pin, metal or plastic toy, nail or sharp object in a load can catch laundry, cause tears and plug the pump. Facial tissue left in a pocket will produce extreme “lint”. A crayon or lipstick in a wash load may cause stains that cannot be removed. Roll down cuffs and shake out grass, sand and gravel.

Strings on clothing such as hooded sweatshirts may get caught in or around the agitator. Remove the strings if possible or tie them together.

Mend Rips and Tears

Little holes can become bigger in the washer. Mend holes and tears before placing garments in the washer.

Close Zipper and Fasten Hooks

These can catch on garments in a wash load and tear them. Tie belts and sashes so they won't wind around clothes.

Check For Colorfastness

Squeeze a portion of garment in warm or hot sudsy water. If the color bleeds or runs, wash the item separately in cold water.

Sort Items

Different items use different wash cycles and temperatures. Always follow the manufacturer's care label. Proper sorting is easy if you follow a few guidelines:

1. Sort by Color: Separate items into loads of whites, darks, lights and non-colorfast.
2. Sort by Fabric and Construction: Separate items into loads of cottons/linens, permanent press, synthetics/blends/poly knits, and delicates.
3. Sort by Temperature: Separate items into loads that can be washed in cold, warm or hot water.
4. Sort by Type and Amount of Soil: Heavily soiled clothes will need extra treatment. Lightly soiled clothes can become dingy if washed with heavily soiled items.
5. Sort Lint “Shedders” From Lint “Receivers”: Some fabrics attract lint and should not be washed with lint-shedding loads. Lint shedders are cottons, terry towels, chenille bedspreads, rugs and clothes that have been heavily bleached. Lint receivers are synthetics, permanent or durable press, knits (including socks), corduroy, and other smooth fabrics.

Pretreat

Pretreat shirt collars and cuffs with a pretreat product or

liquid detergent when placing them in the washer. Before washing, treat special stains individually.

	WARNING
Do not wash or dry items soiled with vegetable or cooking oils. Some oils may remain after washing and may cause the fabric to catch on fire by itself.	
W527	

Loading the Washer

Load Articles

NOTE: Always add detergent first.

- Load larger and heavier items first so they are at the bottom of the washtub.
- Load items by the amount of space they take up, not by their weight.
- Mix large and small items in a load to get the best washing results. For example, don't wash a single large item such as a throw rug. Add several smaller items to avoid an out-of-balance condition.
 - An out-of-balance load may limit spin speeds.
 - The WASH and SPIN STATUS lights will flash twice at the end of a cycle if there was an unbalanced load.
- Washing buoyant items, such as pillows, is not recommended.
- Do not wash a large, bulky, king-size comforter.
- Drop items loosely into the washtub. The bulk of the clothes rather than the weight will determine load size. Do not pack items in or wrap them around the agitator. Overloading can cause poor cleaning, excessive wrinkling and tears.

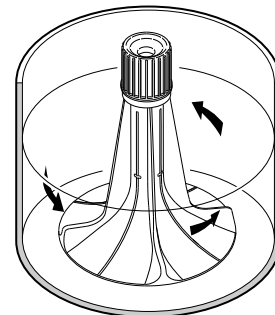

TLW2320N_SVG

- Items should move freely through the wash water for best cleaning results.
- When washing very large items, do not fill washtub as full as with other loads.

Load Size - Auto Fill Water Levels

- This washer has an Auto Fill feature. It will automatically select the proper water level for the load size and type of fabric that is being washed. Auto Fill is recommended for the best wash performance in all cycles.
- Auto Fill works in multiple stages. During the first fill step of the cycle, water will fill to the minimum level programmed for the specific cycle selected. Once the wash step begins, the control starts sensing the load. Once sensing is complete more water may be added to optimize wash results.
- If you pause the cycle after it started, the Auto Fill sensing stage will begin again once the cycle is resumed. It will determine if any items have been added and if more water is needed.
- Overloading the washtub can result in poor washing and rinsing.

Load Size - Manual Water Levels

- Although the Auto Fill selection is recommended for the best wash performance in all cycles, there are two manual load size selections as well.
- The water level in your washer should fit the size of your wash load. Small loads will use lower water levels. There must be enough water in the washtub to allow items to move and turn over freely.

WRONG Water Level for Size of Load



CORRECT Water Level for Size of Load

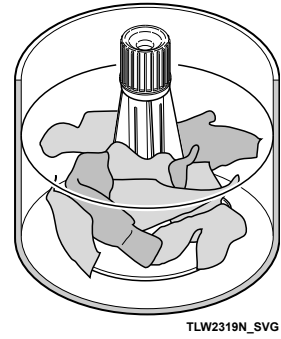

- Overloading the washtub can result in poor washing and rinsing.

IMPORTANT: If in doubt when using a manual selection, always use a larger load size. Most average loads will require the Large Load Size setting. Failure to have the correct volume of water relative to the load may decrease washer performance.

Manual Load Sizes	
Small	1-2 permanent press dress shirts or 2 pillow cases or 1 lightweight dress or similar size load
Large	8-9 shirts, 5 pair polyester pants or 2 queen size sheets, 4 pillow cases, 2 nightgowns, 1 pair men's pajamas or 1 queen size bedspread

The manual load size water levels will vary depending on the wash cycle selected. If the wrong load size is selected, the machine may add more water.

Wash Temperature

Hot

Hot water is the most effective for cleaning, but it is not recommended for all fabric types (read labels).

Warm

The Warm Wash is useful for providing a thorough cleaning on light and moderately soiled clothing without damaging fabric or adding to color fading. Warm water also reduces wrinkling. Use with non-colorfast or dark colors, permanent press, silks, woolens, nylon, and acrylic.

Cool (Select Models Only)

The Cool Wash temperature is useful for washing permanent press fabrics.

Cold

The Cold Wash is ideal for delicate items. Although its cleaning abilities are not as great as with hot or warm water, it is useful for colors that bleed easily and for sensitive fabrics.

All rinses use cold water. It is the most beneficial for fabrics. Cold rinses reduce wrinkling and color fading. In addition, cold rinses will save money and energy.

NOTE: In wash temperatures colder than 60°F [16°C], detergents do not dissolve well. This may cause ineffective cleaning, or lint and residue to form.

NOTE: Always follow manufacturer’s care labels.

Water Supply Temperature

Water temperature is determined by the temperature of the incoming water supply. The washer does not heat or cool the water.

For example, northern climates will have much colder incoming water during the winter months. Southern climates will have much warmer cold water during the summer months.

Wash Temperature Guide

Water Temperature	Use	Comments
HOT	<ul style="list-style-type: none"> Sturdy whites and colorfast items Work clothes Soiled items Diapers 	<ul style="list-style-type: none"> Best cleaning for items soiled with oily or greasy stains, grass, or ink.
WARM	<ul style="list-style-type: none"> Light and moderately soiled items Non-colorfast or dark colors Permanent press Silks, woolens, nylon, acrylic 	<ul style="list-style-type: none"> Reduces wrinkling in permanent press fabrics Less fading Reduces shrinking in knits
COOL	<ul style="list-style-type: none"> Permanent press Silks, woolens, nylon, acrylic 	<ul style="list-style-type: none"> Less fading Reduces shrinking in knits
COLD	<ul style="list-style-type: none"> Non-colorfast fabrics Extra delicate clothing 	<ul style="list-style-type: none"> Saves energy Reduces color fading Reduces wrinkling Reduces shrinking

Table 1

Energy

You can save energy when washing by following these guidelines:

1. Save on heating water by using colder washes. Heating water accounts for the greatest energy expense when washing.
2. Wash full loads, but do not overload.
3. Use soak option, if available, for heavily soiled items to reduce the need for longer wash times.

Operating Your Washer

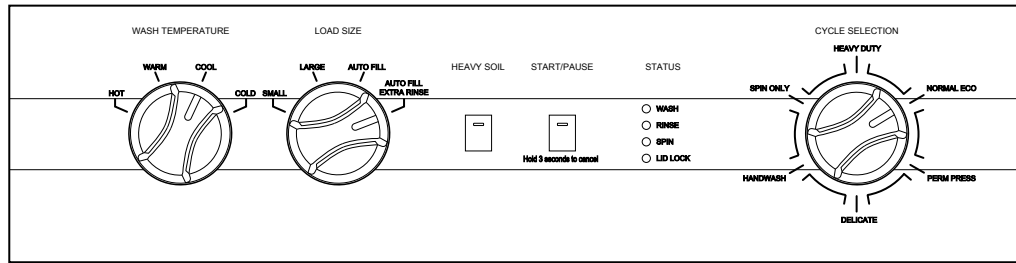

TLW2374N_SVG

Determine Proper Cycle

The following cycle descriptions will help determine which cycle to choose depending on the type of laundry being washed.

Heavy Duty

Use for sturdy items, like play or work clothes, heavily soiled jeans, T-shirts, etc. There is a longer wash time for the best results when cleaning heavily soiled items.

Normal Eco

This cycle uses a spray rinse to reduce water consumption. It also uses less hot water. This cycle is recommended for washing everyday cottons and linens. If using fabric softener in this cycle, select the AUTOFILL/EXTRA RINSE option.

Perm Press

Use for permanent press items and synthetics. The final spin is a medium spin speed.

Delicate

Wash items with delicate and/or gentle on the garment tag in this cycle. Due to this cycle's uniquely designed motion, stiff jeans and throw rugs also wash well in this cycle.

This cycle is designed to gently move items through the water so it fills to a higher water level. It also has a low speed final spin.

Waterproof Items

If waterproof or water-resistant items need to be washed, use only the Delicate Cycle.

Examples of waterproof items include rain coats and bed liners. Load the items evenly and load washtub no more than 1/2 full. For best washing results, add another item such as a cotton sheet on top of the waterproof items to make sure they get fully submerged in the water and that no air is trapped under the waterproof items.



WARNING

Failure to closely follow these instructions may result in an abnormal vibrating and out-of-balance condition that could result in physical injury, property damage and/or appliance damage.

W957

Handwash (Select Models Only)

Wash items with handwash on the garment tag in this cycle. This cycle is designed to gently move items through the water so it fills to a higher water level. It includes a gentle agitation only, a short wash time, cold water, and a very low spin.

Spin Only (Select Models Only)

Use this cycle to extract water from wet items. The cycle uses the high spin.

If AUTOFILL/EXTRA RINSE is turned ON, this cycle will be a rinse and spin cycle.

Load Size

The Load Size Selection determines the amount of water used in the cycle.

Choose Small, Large, Auto Fill or Auto Fill/Extra Rinse according to the amount of laundry being washed.

Auto Fill will provide the most efficient use of water and also enhance wash performance by optimizing the water level for each particular load size and type.

Auto Fill/Extra Rinse is useful for detergent sensitive skin. By selecting this option, the cycle will provide an additional rinse.

NOTE: Auto Fill works in multiple stages. During the first fill step of the cycle, water will fill to the minimum level programmed for the specific cycle selected. Once the wash step begins, the control starts sensing the load. Once sensing is complete more water may be added to optimize wash results. This process may take several fills to optimize the water level. It is part of the machine's normal operation.

Heavy Soil

This option extends the wash time for heavily soiled items by 4 minutes in most cycles. In the Normal Eco cycle, the wash will include additional short soak periods before agitation begins, and will add about 27 minutes to the cycle.

Status

The active Status light will flash at the beginning of the cycle. The Status lights are lit throughout the cycle to show what part of the cycle is running.

Light	Description
Wash	The Wash status light is lit during the first fill step and the wash step of the cycle.
Rinse	The Rinse status light is lit during the rinse portions of the cycle including Extra Rinse, if selected.
Spin	The Spin status light is lit during the final spin portion of the cycle.
Lid Lock	The Lid Lock status light will flash when trying to lock. It is lit any time the lid is locked.

Table 2

Audio Signals

An audio signal will sound for three seconds at the end of each cycle. To turn it off, hold the Heavy Soil button for three seconds. Hold it again for three seconds to turn the signal back on. A one-second tone will sound to confirm that the End of Cycle signal is turned off or on.

Audio signals will sound when a knob selection is changed and when the Start/Pause or Heavy Soil buttons are pressed. To turn them off, hold the Heavy Soil button for 10 seconds. Hold it again for 10 seconds to turn the signals back on. A three-second tone will sound to confirm that these signals are turned off or on.

In addition, the Status lights will be lit in an upward pattern when the signal is turned on. The lights will be lit in a downward pattern when the signal is turned off.

To Wash Clothes

IMPORTANT: Before using your new washer, make sure the washer cord is connected to an appropriate electrical outlet that is properly installed and connected to a protective earth/ground. Make sure the washer hoses are connected to the hot and cold water faucets, and that the faucets are turned on. Be sure the drain hose is not kinked and is inserted into a drain. Refer to the **INSTALLATION INSTRUCTIONS** for details of proper washer installation.

IMPORTANT: Prior to first wash, use an all purpose cleaner, or a detergent and water solution, and a damp cloth to remove shipping dust from inside of wash drum.

1. Get the clothes ready for washing. Empty pockets and cuffs. Sort items into separate loads. Pretreat stains and heavily soiled areas.

IMPORTANT: Remove all sharp objects from laundry to avoid tears and rips to items during normal machine operation.

2. Measure and add low sudsing, High Efficiency (HE) detergent to the washtub. Follow instructions on detergent package for amount to use.

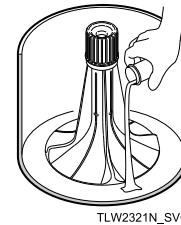

TLW2321N_SVG

NOTE: High efficiency (HE) detergent is recommended for use in this machine. Look for the HE logo or "high efficiency" on the detergent's label.

3. Add clothes loosely into the washtub (16 lbs. [7.2 kg] maximum dry clothes load).

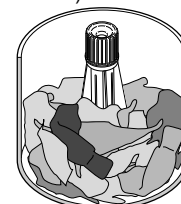

TLW2323N_SVG

4. Close the lid. The washer will not fill, agitate or spin with the lid open.

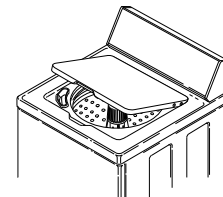

TLW2324N_SVG

	WARNING
<p>To reduce the risk of serious injury, do not by-pass the lid switch or lid lock to permit the washer to agitate or spin with the lid open.</p>	
W939	

5. Set the WASH TEMPERATURE control. (All rinses are cold.)
6. Set the LOAD SIZE (water level) control, AUTO FILL, or AUTO FILL/EXTRA RINSE.
7. Select HEAVY SOIL if desired.
8. Select the cycle according to the type of fabric being washed. Refer to *Determine Proper Cycle*. If the selected cycle is not the correct cycle for the fabric being washed, you may change the cycle selection at any time until the first wash fill is complete.

IMPORTANT: Once the first wash fill is complete, changing the Cycle Selection knob will have no effect.

NOTE: The Normal Eco cycle is recommended for everyday cottons and linens.

9. Press the START/PAUSE button to begin the cycle. The lid will stay unlocked during the first fill and agitate steps so you can easily add items. The lid will lock automatically after the agitate step is complete and the rest of the cycle will begin. To unlock/open the lid after the lid has locked, refer to *Pausing the Cycle*.

NOTE: Lid must be closed for fill, agitation and spin to start.

During the first fill when the Auto Fill Load Size is selected, water fills to the minimum level programmed for the specific cycle selected. Once the wash step begins, the control starts sensing the load. Once sensing is complete more water may be added to optimize wash results.

The washer will stop (pause) shortly before the wash and rinse spins. This is a normal part of the cycle.

The lid will automatically unlock at the end of the cycle after a short pause to ensure there is no washtub movement.

NOTE: The lid must be opened after a cycle ends and then closed before the next cycle can be started. If this is not done before pressing Start, the Start/Pause LED will flash and washer will sound a tone. To clear, open and close the lid.

Pausing the Cycle

NOTE: A cycle cannot be paused immediately after starting it. There is a short delay while the machine is energizing.

The lid will stay unlocked during the first fill and agitate steps so you can easily add items. Lifting the lid during this time will pause the cycle. The Start/Pause button must be pressed after the lid is closed to resume the cycle.

After the lid has locked, a cycle can be paused to unlock/open the lid, however, the cycle selection can't be changed at this time.

1. To pause a running cycle, press the Start/Pause button once. The current Status light will go out.
2. The lid will unlock after about 10 seconds if the cycle is in agitate or up to 60 seconds if the cycle is in spin.
3. The LID LOCK Status light will flash to indicate the cycle is paused.
4. Press the Start/Pause button again to resume the cycle. It will start from the place it was in the cycle when paused.

The Auto Fill sensing stage will begin again after the cycle has been restarted. If a cycle is paused to add an item, once the cycle resumes it will sense if additional water is needed.

Canceling the Cycle

You can change the cycle during the first wash fill. If you need to change the cycle after that you must cancel it first.

1. To cancel a cycle, hold the Start/Pause button for three seconds.
2. The lid will unlock after about 10 seconds if the cycle is in agitate or up to 60 seconds if the cycle is in spin.
3. The LID LOCK Status light will go out.
4. You can now change the cycle type, if desired. For example, you may want to change it from HEAVY DUTY to DELICATE depending on the type of clothes being washed.
5. Press the Start/Pause button to start the new cycle.

NOTE: If you change the cycle and press Start/Pause before the lid unlocks, the new cycle will begin after the motor has stopped.

Cycle Operation

The cycles of your washer include several different stages. Refer to the tables below for what can be expected during the cycles that you select.

The times listed are the default times. They are approximate and will vary depending on the cycle and options chosen.

The Extra Rinse option must be selected to be included in the cycle.

NOTE: The rinse water temperature will be cold, including when optional rinses are selected.

Normal Eco Cycle					
Cycle Stage	Activity	Default Time (minutes)	Agitation Level	Spin Speed	Comments
Wash	Fill/Agitate	34:00	High	Medium	
Extra Rinse	Spin/Fill/Agitate/Spin	18:00	High	Medium	Option
Final Spin	Spin-Spray	14:30		High	
Total (without Option)		48:30			

Heavy Duty, Perm Press, Delicates , Handwash Cycles					
Cycle Stage	Activity	Default Time (minutes)	Agitation Level	Spin Speed	Comments
Wash	Fill/Agitate/Spin	Heavy Duty = 28:30 Perm Press = 19:30 Delicates , Handwash = 18:30	Heavy Duty = High All Others = Medium	Heavy Duty = Medium All Others = Low	
Extra Rinse	Fill/Agitate/Spin	12:30	Heavy Duty = High All Others = Medium	Heavy Duty = Medium All Others = Low	Option
Rinse	Fill/Agitate	6:30	Heavy Duty = High All Others = Medium		

continues...

Heavy Duty, Perm Press, Delicates , Handwash Cycles					
Cycle Stage	Activity	Default Time (minutes)	Agitation Level	Spin Speed	Comments
Final Spin	Spin	10:00		Heavy Duty = High Perm Press = Medium Delicates , Handwash = Low	
Total (without Option)		Heavy Duty = 45:00 Perm Press = 36:00 Delicates , Handwash = 35:00			

Spin Only Cycle					
Cycle Stage	Activity	Default Time (minutes)	Agitate Level	Spin Speed	Comments
Extra Rinse	Fill/Agitate/Spin	12:30	High	Medium	Option
Final Spin	Spin	10:00		High	
Total (without Option)		10:00			

Common Washer Sounds

Sounds	Cause
Pump turning on and off during spin part of cycle	The pump will turn off and on several times during the final spin cycle.
Washer speeding up during wash part of cycle	Depending on the cycle, the wash routine will either pick up speed or slow down.
Clicking toward the bottom of washer after pushing Start	The motor control is powering up.
Clicking near lid	The lid lock is engaging.
Lid lock clicking at end of cycle or while pausing	The lid lock needs to make two clicks before fully releasing. Wait to hear both before opening the lid.

Table 3

Optional Features

Bleach Dispenser

The bleach dispenser is located in the left front corner, under the lid.

Use liquid bleach in the dispenser. Powdered bleach must not be used in the dispenser. Add powdered bleach to the wash water.

Use no more than one cup chlorine bleach for large loads and one-half cup for small loads.

Carefully pour recommended amount of bleach into the dispenser before the start of the wash cycle.

Be careful not to spill undiluted bleach. It is a strong chemical and can damage some fabrics if it is not properly diluted.

Bleach is very corrosive and overfilling the dispenser can cause chemical damage to the washer components. Components damaged by bleach are not covered under the product warranty.

Fabric Softener Dispenser

Fabric softener should not be used with the Normal Eco or Spin Only cycles unless the Extra Rinse option is also selected.

To Use Dispenser

After the clothes are loaded into the washtub and before the start of the WASH cycle, pour the proper amount of liquid fabric softener into the bottle measuring cap (refer to bottle directions). Pour into dispenser.

The large fabric softener dispenser allows for the fabric softener to be diluted with water. We recommend adding water up to the fill level. Do not exceed tip of arrow which indicates correct fill level. Over-filling can allow fabric softener to spill onto the clothes, causing stains on clothes if the softener comes into contact with detergent suds.

Setting the water level to Large, Auto Fill or Auto Fill/Extra Rinse will result in better performance from the fabric softener.

The fabric softener will remain in the dispenser during the wash fill, agitation and spin. At the end of the wash spin, the liquid fabric softener will be dispensed into the washtub through the slots in the agitator and will be mixed with the incoming rinse water.

To Clean Dispenser

1. Grasp the entire fabric softener assembly firmly with both hands and place your thumbs inside the hole at the top.
2. Pull quickly up and towards you. The assembly will come off the agitator.
3. Lay down a cloth on a hard, flat surface.
4. Lay the assembly on the cloth on its side so the vertical lines are facing up.
5. Place your palms on the ridge at the base of the dispenser housing and press down firmly. The assembly will split apart for easy cleaning.
6. Soak housing, cup and funnel in hot soapy water. Use a small brush to scrub if needed.
7. Rinse housing, cup and funnel clean.
8. The inside of the agitator can also be cleaned.
9. After cleaning, install dispenser funnel, cup and housing until they click into place.
10. Push assembly directly downward onto top of agitator until firmly snapped in place.

IMPORTANT: When adding detergent to the wash load, **DO NOT** allow any detergent to enter the softener dispenser cup. If this happens, refer to the cleaning instructions.

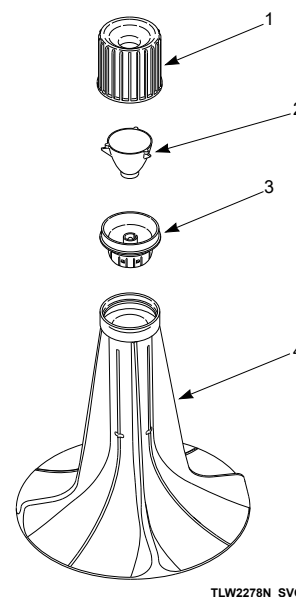

TLW2278N_SVG

1. Dispenser Housing
2. Dispenser Cup
3. Dispenser Funnel
4. Agitator

Use Tips

- Fabric softener spilled onto garments may cause staining. To remove, dampen stain and rub with bar soap. Wash as usual.
- Liquid fabric softeners will be dispensed during the first rinse and should not be combined with bleach, bluing, starch, detergents, soaps or packaged water conditioners.
- When adding detergent to wash water, do not allow any to enter into softener dispenser cup, as softener will become gummy.

To prevent softener buildup, the dispenser can be filled with clean water for automatic cleaning. This can be done in washing cycles other than when softener is used.

Clothing Care

Clothing Concerns

To keep clothes looking white or bright, use good washing practices at all times to prevent a gradual build-up of soil or water hardness minerals on them. If you notice that your clothes are not as bright as they should be, take corrective measures immediately.

Problem	Cause	Solution
Gray or Dingy Clothes	Insufficient Detergent	Add more detergent to washtub before loading clothes. Mild detergents are not suitable for average soil.
	Improper Sorting	Wash whites separately. Separate light from heavily soiled items. Clothes can pick up soil from dirty wash water.
	Nonphosphate Detergent and Hard Water	Follow package directions. Soften water if possible.
	Water Not Hot Enough	White clothes will stay whiter with hot wash water. Increase temperature.
	Overcrowding Washer	Clothes must circulate freely through the water for best results.
Yellowed Clothes	Unremoved Soil	Skin soil is hard to remove. Check hem edge of sheets and pillowcases, bottom end of t-shirts, etc. If this portion is white and center is yellow, the fabric contains unremoved soil. Use sufficient detergent and a hot wash. Chlorine bleach may be needed.
	Clothes Stained from Iron in the Water	To test for an iron stain, use a rust remover that is recommended for use with washing machines on a portion of the garment. Follow bottle directions for larger items.
	Older Clothes	Some white fabrics turn yellow with age and cannot be whitened.
Clothes Tearing or Damaged	Improper Use of Chlorine Bleach	No correction for bleach damaged clothes. Always measure and dilute bleach. Take extra care to avoid unwanted spilling.
	Insufficient Precare	Fasten all hooks and zippers. Mend tears. Remove objects from pockets.
	Overcrowding or Overloading	Make sure all items can move freely during agitation.

continues...

Problem	Cause	Solution
Excessive Lint	Improper Sorting	Fabrics that shed lint cannot be washed with fabrics that receive lint.
	Insufficient Detergent/Non-phosphate Detergent	Use enough detergent so lint remains suspended in water and flushed out. Do not oversuds the water.
	Mixing Fabric Types	Knits and permanent press attract lint. Wash these only with similar items. Use fabric softener in rinse water.
Wrinkling	Improper Sorting	Heavy items like towels should not be washed with light items like nightgowns.
	Improper Cycle	Make sure cycle selected is appropriate for type of clothes.
	Improper Temperature	Using a warm or cold wash and a cold rinse reduces wrinkling.
	Too Many Clothes in Washer	Clothes must circulate freely through the water for best results.

Maintenance

Cold Weather Care

If the unit is delivered on a cold day (below freezing), or is stored in an unheated room or area during the cold months, do not attempt to operate the washer until it has had a chance to warm up. Water from the previous cycle may remain.

Winterizing the Washer

Follow these steps to prevent damage from freezing water.

1. Unplug washer.
2. Remove two screws from bottom of front panel.
3. Remove hose from drain pump.
4. Let water drain out and reconnect hose.
5. Turn off water supply.
6. Remove fill hoses and allow them to drain.
7. Use compressed air to blow water out of water valve:
 - a. Plug washer into electrical power.
 - b. Select a Warm wash temperature.
 - c. Start a cycle. This will open both sides of water valve.
 - d. Use compressed air to blow out any residual water.

Care of Your Washer

Use only a damp or sudsy cloth for cleaning the control panel. Some cleaning products may harm the finish on the control panel or damage the interior. DO NOT use products that contain alcohol on the control panel. Wipe the panel dry after cleaning.

Wipe the washer cabinet as needed. If detergent, bleach or other washing products are spilled on the cabinet, wipe immediately. Some products will cause permanent damage if spilled on the cabinet.

Do not use scouring pads or abrasive cleansers on control panel or cabinet.

Leave the lid open to allow the inside of the washer to dry out after use. This helps prevent musty odors from developing.

The agitator should not be removed except for service. The washtub is designed to be self cleaning, though it may need rinsing or wiping after some unusual loads have been washed. This may also be necessary if too little detergent has been used.

Replacing Hoses

Hoses and other rubber parts deteriorate after extended use. Hoses may develop cracks, blisters or material wear from the temperature and constant high pressure they are subjected to.

All hoses should be checked on a monthly basis for any visible signs of deterioration. Any hose showing the signs of deterioration listed above should be replaced immediately. All hoses should be replaced every five years.

Flood safe hoses often can be the cause for no fill or slow fill issues. They are not recommended. Only use replacement fill hoses from the manufacturer.

Filter Screens

Check the filter screens in the fill hoses for debris or damage every six months. Clean or replace them if necessary.

If the washer is filling with water slower than normal, check the filter screens. Clean or replace them if necessary.

Order filter screen Part No. 803615 from the nearest authorized parts distributor.

Vacations and Extended Non-Use

IMPORTANT: To avoid possible property damage due to flooding, turn off the water supply to the washer whenever there will be an extended period of non-use.

Preventative Maintenance

Follow these guidelines to ensure the washer operates properly. Call for service if you observe any of the following: water of any amount on the floor, an increase in operating noise or water remaining in the wash basket after a cycle.

Frequency	Maintenance Procedure
Monthly	<ol style="list-style-type: none"> 1. Check all hoses and the drain for leaks. 2. Check the lid switch for proper operation. 3. Check to make sure the washer is level. 4. Clean upper 2-3 inches of wash tub. Fill washer with warm water at highest setting. Use an all-purpose cleaner or a steel wool soap pad.
Every six months	<ol style="list-style-type: none"> 1. Clean the filter screens in the fill hoses.
Every five years	<ol style="list-style-type: none"> 1. Have a qualified service technician conduct general preventative maintenance on the washer to ensure it operates properly. 2. Replace the fill hoses.

Table 4

Reinstallation of Shipping Materials

You must install the shipping brace and shipping plug any time the washer is moved.

Shipping Brace

The shipping brace in the lid opening should be saved and reinstalled whenever the washer is moved. To reinstall the brace, open the washer lid and place the brace over the

washer agitator, placing the back of the brace into the lid opening first.

Shipping Plug

The plastic shipping plug should be saved and reinstalled any time the washer is moved. The plug fits into two openings: The base opening and the shipping plug opening on the bottom of the movable pivot dome. The plug **MUST** be inserted into both openings to prevent damage to the washer. In order to accomplish this, the shipping plug opening must be directly lined up with the base opening.

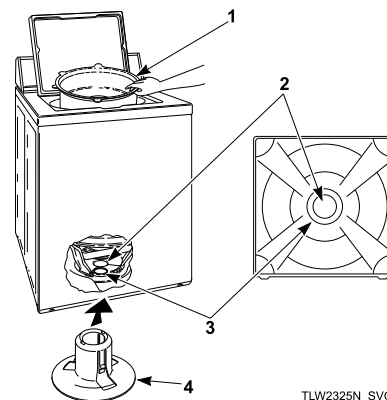

1. Shipping Brace
2. Shipping Plug Opening
3. Base Opening
4. Shipping Plug

After the shipping brace has been installed in the lid opening, tilt washer back enough to access base opening.

Insert shipping plug into base opening and, using the palm of your hand, push shipping plug into washer until it snaps into shipping plug opening.

Troubleshooting

Try these troubleshooting tips before making a service call.
They may save you time and money.

Washer Symptom	Possible Cause/Solution
Won't Fill	<ul style="list-style-type: none"> • Make sure power cord is plugged all the way into the electrical outlet. • Make sure hot and cold water faucets are turned on. • Make sure lid is closed. • Make sure that the fill hoses are not kinked or twisted. • Press Start/Pause button to start washer. • Make sure that the controls are properly set. • In the Normal Eco cycle, during the rinse portion of the cycle, the tub won't fill with water. Instead, there is a spray rinse. • Make sure that the last spin has been completed. • Check the laundry room fuse or circuit breaker. • Clean the screens in the water mixing valve and the filter screens located at the faucet end of the fill hoses. (Owner is responsible for service calls regarding cleaning of the screens.) • Water is being siphoned from the washer during the cycle. Refer to the Installation instructions to make sure that the drain hose has been properly installed. • Are flood safe stainless steel hose devices installed on the fill hoses? Such assemblies are designed to shut off the water flow if an increase in flow volume is detected (such as a burst hose). It is possible the devices are activating falsely.
Won't Start	<ul style="list-style-type: none"> • Make sure lid is closed. • Press Start/Pause button to start washer. • Make sure power cord is plugged all the way into the electrical outlet. • Make sure that the controls are properly set. • Check the laundry room fuse or circuit breaker.
Won't Agitate	<ul style="list-style-type: none"> • Make sure lid is closed. • Press Start/Pause button to start washer. • Make sure power cord is plugged all the way into the electrical outlet. • Check the laundry room fuse or circuit breaker. • Broken drive belt. Call the service person.
Won't Spin	<ul style="list-style-type: none"> • Make sure lid is closed. • Press Start/Pause button to start washer. • Make sure power cord is plugged all the way into the electrical outlet. • Check the laundry room fuse or circuit breaker. • Broken drive belt. Call the service person.
Stops/Pauses During Cycle	<ul style="list-style-type: none"> • Pauses are part of the washer's normal operation. The washer will stop (pause) shortly before the wash and rinse spins. • Check the laundry room fuse or circuit breaker.

continues...

Washer Symptom	Possible Cause/Solution
Won't Drain	<ul style="list-style-type: none"> • Make sure drain hose is not kinked or twisted. • Make sure drain hose is not clogged. • Make sure drain receptacle is not clogged. • Refer to the Installation instructions to make sure that the drain hose has been properly installed.
Water Leaks	<ul style="list-style-type: none"> • Check that fill hoses are properly installed on the faucets and the washer's water mixing valve. • Check the condition of the fill hoses. Replace fill hoses every five years. • Make sure drain receptacle is not clogged. • Check laundry room plumbing. • Check house water pressure. In cases of extremely low water pressure, leaking may occur. • Laundry load may be oversudsing or overloaded. Use less detergent (or low-sudsing detergent) and proper load sizes.
Is Noisy	<ul style="list-style-type: none"> • Wash load may be unbalanced. Open lid and redistribute the load. • Make sure washer is level. Uneven leveling can cause vibration. • A newly installed washer may make a knocking sound if the machine has been in storage. The belt may have settled. Run washer through 4-5 cycles to loosen belt. Washer operation will not be affected.
Load Is Too Wet	<ul style="list-style-type: none"> • Wash load may be unbalanced. Open lid and redistribute the load. • Load is too small. Add items to make full load.
Wrong Water Temperature	<ul style="list-style-type: none"> • Make sure that the controls are properly set. • Check fill hoses. Make sure hot faucet hose is connected to hot mixing valve (indicated with "H" on the valve bracket) and cold faucet is connected to cold mixing valve (indicated with "C" on the valve bracket). • Make sure laundry room water heater is adjusted properly. • The Normal Eco cycle uses a colder water temperature.
Too Many Soap Suds	<ul style="list-style-type: none"> • Laundry load may be oversudsing. Make sure you are using low-sudsing, high efficiency (HE) detergent. • Make sure you are using the amount of detergent recommended on the detergent's label. If using non-HE detergent, use only 1/2 of the detergent manufacturer's recommended amount. • Laundry load may be overloaded. Make sure you are using proper load sizes.
Start/Pause LED flashing, plus audio tone after pressing Start	<ul style="list-style-type: none"> • This occurs if consecutive cycles are run without opening and closing the lid between cycles. • Ensures proper safety measures are in place. • To clear code, open and close the lid.
Status Lights Flashing	<p>Status lights may flash or remain on continuously to indicate an error condition. The number of flashes listed below is followed by a pause. Then the flash sequence will repeat.</p>

continues...

Washer Symptom	Possible Cause/Solution
<p>WASH, RINSE STATUS lights flash 2 times Fill Error</p>	<ul style="list-style-type: none"> • This code will appear if the washer has not reached the fill level after 30 minutes during a wash or rinse fill. • Make sure hot and cold water faucets are turned on. • Make sure that the fill hoses are not kinked or twisted. • Clean the screens in the water mixing valve and the filter screens located at the faucet end of the fill hoses. • Unplug the machine for 15 seconds to clear this code.
<p>WASH, RINSE STATUS lights on continuously Drain Error</p>	<ul style="list-style-type: none"> • This code indicates that water is still in the washer at the end of the cycle. • Check the drain hose and drain receptacle to make sure they are installed properly and not blocked. • Unplug the machine for 15 seconds to clear this code.
<p>WASH, RINSE STATUS lights flash 1 time Pressure Sensor Error</p>	<ul style="list-style-type: none"> • The control has detected trouble sensing the water fill level. • Unplug the machine and call for service.
<p>RINSE, LID LOCK STATUS lights flash 3 times Lid Open Error</p>	<ul style="list-style-type: none"> • The control senses that the lid is open during a running cycle. • Unplug the machine to clear this code.
<p>RINSE, LID LOCK STATUS lights flash 2 times Lid Lock Error</p>	<ul style="list-style-type: none"> • The control senses that the lid has unlocked during a running cycle. • Unplug the machine to clear this code.
<p>WASH, RINSE STATUS lights flash 2 times No Water Flow Error</p>	<ul style="list-style-type: none"> • The washer has not filled to the proper water level. • No or very little change in water level has been sensed within 5 minutes of the current fill. • Make sure hot and cold water faucets are turned on. • Make sure that the fill hoses are not kinked or twisted. • Clean the screens in the water mixing valve and the filter screens located at the faucet end of the fill hoses. • Unplug the machine for 15 seconds to clear this code.
<p>WASH, RINSE STATUS lights on continuously Overflow Error</p>	<ul style="list-style-type: none"> • This code indicates the washer has filled to the overflow level. • The machine will begin to attempt to pump water out if the lid is closed and locked. • If the code does not clear, unplug the machine and call for service.
<p>RINSE, LID LOCK STATUS lights flash 3 times Lid Unlocking Error</p>	<ul style="list-style-type: none"> • The control senses that the lid will not unlock. • Unplug the machine for three minutes to unlock the lid. • If the code appears again, call for service.
<p>RINSE, LID LOCK STATUS lights flash 2 times Lid Locking Error</p>	<ul style="list-style-type: none"> • This code indicates that the lid has not locked. • Make sure the lid is closed all the way and try to start the cycle. • Open the lid or unplug the machine to clear the code. • If this code continues, call for service.

continues...

Washer Symptom	Possible Cause/Solution
<p>WASH, SPIN STATUS lights flash 2 times</p> <p>Max Speed Not Reached Error</p>	<ul style="list-style-type: none"> • This code indicates that the washer did not reach the maximum intended speed in the final spin. • This could be due to an unbalanced load, excessive suds in the load, or too much water left in the tub due to slow draining. • Be sure to use proper load sizes that are evenly distributed in the wash basket. • Be sure to use high efficiency (HE) detergent. • Open the lid or press the Start/Pause button to clear this code.
<p>WASH, RINSE STATUS lights flash 3 times</p> <p>Suds Lock Error</p>	<ul style="list-style-type: none"> • This code will be displayed after a cycle until the lid is opened or the Start/Pause button is pressed. It indicates an oversudsing condition. • Laundry load may be oversudsing. Make sure you are using low sudsing, high efficiency (HE) detergent. If using non-HE detergent, use only 1/2 of the detergent manufacturer's recommended amount. • Laundry load may be overloaded. Make sure you are using proper load sizes.
<p>All STATUS lights flashing</p>	<ul style="list-style-type: none"> • If the all STATUS lights flash, unplug the machine for 15 seconds. Plug the machine back in. If the lights still flash, call for service.

Warranty Repairs

If your appliance needs repair, locate an authorized service provider directly from our support page at www.speedqueen.com.

Before scheduling service, please consult Limited Warranty for full terms. As a reminder, the following items are not covered by the limited warranty and, if a service technician is called, you will be responsible for payment of the service call.

- Plugged or restricted drain pipes
- Plugged or restricted water filters or fill valve screens
- Home electrical issues
- Foreign objects found inside the washer or pump
- Drain issues caused by standpipes that exceed factory specifications
- Instruction on how to use machine
- Issues related to improper installation

As detailed in the Limited Warranty, if the unit is operated in a multiple-user setting or commercial application, the unit's limited warranty is three (3) years parts only. Labor coverage is not included in this warranty.

Contact Information

If you have any questions or need assistance with your appliance, please visit us online at www.speedqueen.com. From our website you can:

- Register your appliance
- Find manuals and other product literature
- Locate authorized service providers near you
- Locate replacement parts

If additional support is needed, contact us using one of the following methods:

Phone: (920) 748-3121 or (800) 552-5475

Contact Us Form: www.speedqueen.com/contact/

Mail: Speed Queen
Shepard Street
P.O. Box 990
Ripon, WI 54971-0990

When contacting us, please provide the following information:

- Date Purchased
- Model Number
- Serial Number

The Model and Serial Numbers are located on the serial plate. The serial plate will be in the location shown.

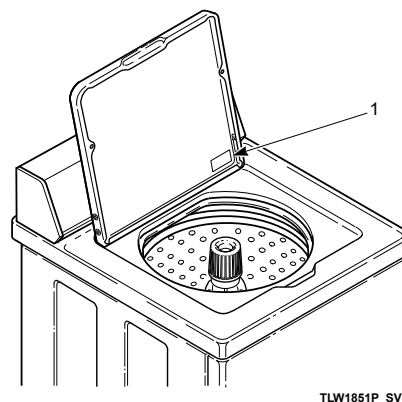

1. Serial Plate

	WARNING
<p>To reduce the risk of serious injury or death, DO NOT repair or replace any part of the unit or attempt any servicing unless specifically recommended in the user-maintenance instructions or in published user-repair instructions that you understand and have the skills to carry out.</p>	
W329	