



Washer

User manual

WA55CG7500**/WA54CG7550**

SAMSUNG

Contents

Safety information	4
What you need to know about the safety instructions	4
Important safety symbols	4
IMPORTANT SAFETY INSTRUCTION	5
CALIFORNIA PROPOSITION 65 WARNING	5
Critical installation warnings	6
Installation cautions	7
Critical usage warnings	7
Usage cautions	9
Critical cleaning warnings	11
Regulatory notice	12
FCC Notice	12
IC Notice	13
Open Source Announcement	14
Installation	15
Unpacking your washer	15
What's included	16
Installation requirements	18
Step-by-step installation	21
Before you start	28
Initial settings	28
Laundry guidelines	28
Detergent drawer guidelines	33
Operations	38
Control panel	38
Simple steps to start	41
Cycle overview	42
Cycle chart	44
Special features	46
SmartThings	50
Smart Care	51

Maintenance	52
SELF CLEAN	52
Cleaning the exterior	53
Cleaning the interior	53
Care for an extended period of non-use	53
Pet hair filter (applicable models only)	54
Cleaning the mesh filter	56
Cleaning the detergent drawer	57
Troubleshooting	59
Checkpoints	59
Information codes	63
Specifications	66
Fabric care chart	66
Helping the environment	67
Declaration of conformity	68
Specification sheet	68

Safety information

Congratulations on your new Samsung washer. This manual contains important information on the installation, use, and care of your appliance. Please take some time to read this manual to take full advantage of your washer's many benefits and features.

What you need to know about the safety instructions

Please read this manual thoroughly to ensure that you know how to safely and efficiently operate the extensive features and functions of your new appliance. Please store the manual in a safe location close to the appliance for future reference. Use this appliance only for its intended purpose as described in this instruction manual.

Warnings and Important Safety Instructions in this manual do not cover all possible conditions and situations that may occur. It is your responsibility to use common sense, caution, and care when installing, maintaining, and operating your washer.

Because the following operating instructions cover various models, the characteristics of your washer may differ slightly from those described in this manual and not all warning signs may be applicable. If you have any questions or concerns, contact your nearest service center or find help and information online at www.samsung.com.

Important safety symbols

What the icons and signs in this user manual mean:

WARNING

Hazards or unsafe practices that may result in **severe personal injury, death, and/or property damage.**

CAUTION

Hazards or unsafe practices that may result in **personal injury and/or property damage.**

NOTE

Indicates that a risk of personal injury or material damage exists.

These warning signs are here to prevent injury to yourself and others. Please follow them explicitly. After reading this manual, store it in a safe place for future reference.

Read all instructions before using the appliance.

As with any equipment that uses electricity and moving parts, potential hazards exist. To safely operate this appliance, familiarize yourself with its operation and exercise care when using it.

SAVE THESE INSTRUCTIONS

IMPORTANT SAFETY INSTRUCTION

WARNING

To reduce the risk of fire, electric shock, or injury to persons when using your appliance, follow basic precautions, including the following:

1. Read all instructions before using this appliance.
2. Do not wash or dry articles that have been previously cleaned in, washed in, soaked in, or spotted with gasoline, dry-cleaning solvents, oils, other flammable or explosive substances as they give off vapors that could ignite or explode.
3. Do not allow children to play on or in the appliance. Close supervision of children is necessary when the appliance is used near children.
4. Before the appliance is removed from service or discarded, remove the lid of the washing or drying compartment.
5. Do not reach into the appliance if the drum is moving.
6. Do not install or store this appliance where it will be exposed to weather, including wind, rain, or snow.
7. Do not tamper with the controls.
8. Do not repair or replace any part of the appliance or attempt any servicing unless it is specifically recommended in the user-maintenance instructions or in published user-repair instructions that you understand and have the skills and are qualified to carry out.
9. Do not add gasoline, dry-cleaning solvents, or other flammable or explosive substances to the wash water. These substances give off vapors that could ignite or explode.
10. Under certain conditions, hydrogen gas may be produced in a hot water system that has not been used for 2 weeks or more. HYDROGEN GAS IS EXPLOSIVE. If the hot water system has not been used for 2 weeks or more, before using a washer or combination washer-dryer, turn on all hot water faucets and let the water flow from each for several minutes. This will release any accumulated hydrogen gas. As the gas is flammable, do not smoke or use an open flame during this time.

CALIFORNIA PROPOSITION 65 WARNING

WARNING

Cancer and Reproductive Harm - www.P65Warnings.ca.gov.

SAVE THESE INSTRUCTIONS

Safety information

Critical installation warnings

WARNING

Plug the power cord into a wall socket that meets local electrical specifications. Use the socket for this appliance only. Do not use an extension cord.

- Sharing a wall socket with other appliances, using a power strip, or extending the power cord may result in electric shock or fire.
- Do not use an electric transformer. It may result in electric shock or fire.
- Ensure that the power voltage, frequency, and current match the product's specifications. Failing to do so may result in electric shock or fire.

Have this appliance installed by a qualified technician or service company.

- Failing to do so may result in electric shock, fire, an explosion, problems with the product, or injury.

Remove all foreign substances such as dust or water from the power plug terminals and contact points using a dry cloth on a regular basis.

- Unplug the power plug and clean it with a dry cloth.
- Failing to do so may result in electric shock or fire.

Plug the power plug into the wall socket in the right direction so that the cord runs towards the floor.

- If you plug the power plug into the socket in the opposite direction, the electric wires within the cable may be damaged and this may result in electric shock or fire.

This appliance must be properly grounded. Do not ground the appliance to a gas pipe, plastic water pipe, or telephone line.

- Improper grounding may result in electric shock, fire, an explosion, or problems with the product.
- Never plug the power cord into a socket that is not grounded correctly. Make sure the socket you use is grounded in accordance with local and national codes.

Do not install this appliance near a heater or flammable material.

Do not install this appliance in a humid, oily, or dusty location, or in a location exposed to direct sunlight or water (rain drops).

Do not install this appliance in a location where gas may leak.

- This may result in electric shock or fire.

Plug the power plug into the wall socket firmly. Do not use a damaged power plug, damaged power cord, or loose wall socket.

- This may result in electric shock or fire.

Do not pull or excessively bend the power cord.

Do not twist or tie the power cord.

SAVE THESE INSTRUCTIONS

Do not hook the power cord over a metal object, place a heavy object on the power cord, insert the power cord between objects, or push the power cord into the space behind the appliance.

- This may result in electric shock or fire.

Do not pull the power cord when unplugging the power plug.

- Unplug the power plug by pulling the plug.
- Failing to do so may result in electric shock or fire.

If the power plug or power cord are damaged, contact your nearest Samsung service center.

Installation cautions

CAUTION

Position the appliance so that the power plug is easily accessible.

- Failing to do so may result in electric shock or fire due to electric leakage.

Install your appliance on a level and hard floor that can support its weight.

- Failing to do so may result in abnormal vibrations, noise, or problems with the product.

Unplug the power plug when the appliance is not being used for long periods of time or during a thunder/lightning storm.

- Failing to do so may result in electric shock or fire.

Critical usage warnings

WARNING

If the appliance is flooded with water, cut the power immediately and contact your nearest Samsung service center.

If the appliance emits a strange noise, a burning smell, or smoke, unplug the power plug immediately and contact your nearest Samsung service center.

- Failing to do so may result in electric shock or fire.

In the event of a gas leak (such as propane gas, LP gas, etc.) in the location where the appliance is installed, ventilate the area immediately without touching the power plug. Do not touch the appliance or the power cord.

- Do not use a ventilating fan.
- A spark may result in an explosion or fire.

SAVE THESE INSTRUCTIONS

Safety information

Do not wash items contaminated with gasoline, kerosene, benzene, paint thinner, oils, alcohol, or other flammable or explosive substances.

- This may result in electric shock, fire, or an explosion.

Do not force the washer lid open while the washer is operating (high-temperature washing/drying/spinning).

- Water flowing out of the washer may cause burns or cause the floor to be slippery. This may result in injury.
- Forcing the lid open can damage the product or cause injury.

Make sure to remove the packaging (sponge, styrofoam) attached to the bottom of the washer before using it.

Do not insert your hand under the washer.

- This may result in injury.

Do not touch the power plug with wet hands.

- This may result in electric shock.

Do not turn the appliance off by unplugging the power plug while the washer is in operation.

- Plugging the power plug into the wall socket again may cause a spark and result in electric shock or fire.

Keep all packaging materials well out of the reach of children, as packaging materials can be dangerous to children.

- If a child places a plastic bag over his or her head, the child may suffocate.

Do not insert your hand or any object under the washer while it is operating.

- This may result in injury.

Do not attempt to repair, disassemble, or modify the appliance yourself.

- Do not use any fuse (such as copper, steel wire, etc.) other than a standard fuse.
- If you need to repair or reinstall the appliance, contact your nearest Samsung service center.
- Failing to do so may result in electric shock, fire, problems with the product, or injury.

If any foreign substance such as water enters the appliance in any area other than the tub, unplug the power plug and contact your nearest Samsung service center.

- Failing to do so may result in electric shock or fire.

If the water supply hose comes loose from the faucet and floods the appliance, unplug the power plug.

- Failing to do so may result in electric shock or fire.

For waterproof fabrics, only use the WATERPROOF cycle.

- Do not use other cycles for waterproof fabrics. This may result in injury or damage to the washer, walls, floor, or clothing due to abnormal vibrations.
- Set the temperature and spin according to the attached care label.

SAVE THESE INSTRUCTIONS

-
- **WARNING** : Failure to closely follow these instructions may result in an abnormal vibrating and out-of-balance condition that could result in physical injury, property damage, and/or appliance damage.

Remove your hands from the top of the washing machine before closing the lid.

- This will prevent any hand injury that may occur when closing the lid.

Usage cautions

CAUTION

If the washer is contaminated by a foreign substance such as detergent, dirt, food waste, etc., unplug the power plug and clean the washer using a damp, soft cloth.

- Failing to do so may result in discoloration, deformation, damage, or rust.

The clear portion of the lid can be broken by a strong impact. Take care when using the washer.

- If the clear portion is cracked or broken, it may result in injury.

After a water supply failure or when reconnecting the water supply hose, open the faucet slowly.

Open the faucet slowly after a long period of non-use.

- The air pressure in the water supply hose or the water pipe may result in damage to a part or in water leakage.

If a drain error occurs during an operation, check if there is a draining problem.

- If the washer is used when it is flooded because of a draining problem, it may result in electric shock or fire due to electric leakage.

Do not insert your hand under the washer.

- This may result in injury.

Insert the laundry into the washer completely so that laundry does not get caught in the lid.

- If laundry gets caught in the lid, it may result in damage to the laundry or the washer, or result in water leakage.

Ensure that the faucet is turned off when the washer is not being used.

- Ensure that the water supply hose connectors are properly tightened.
- Failing to do so may result in property damage or injury.

Open the faucet and check if the water supply hose connector is firmly tightened and that there is no water leaking before using the product.

- If the water supply hose connectors are loose, it may result in water leakage.

Do not stand on top of the appliance or place objects (such as laundry, lighted candles, lighted cigarettes, dishes, chemicals, metal objects, etc.) on the appliance.

- This may result in electric shock, fire, problems with the product, or injury.

SAVE THESE INSTRUCTIONS

Safety information

Do not operate the appliance with wet hands.

- This may result in electric shock.

Do not spray volatile material such as insecticide onto the surface of the appliance.

- As well as being harmful to humans, it may also result in electric shock, fire, or problems with the product.

Do not place an object that generates an electromagnetic field near the washer.

- This may result in injury due to a malfunction.

Since the water drained during a high-temperature wash or drying cycle is hot, do not touch the water.

- This may result in burns or injury.

Do not operate the washer if the detergent dispenser is removed.

- This may result in electric shock or injury due to water leakage.

Do not insert your hand into the detergent dispenser after opening it.

- This may result in injury as your hand may be caught.

Do not place any non-laundry objects, such as shoes, food waste, or animals into the washer.

- This can cause abnormal vibrations that can damage the washer, and, in the case of pets, cause severe injury or death.

Do not press the buttons using sharp objects such as pins, knives, fingernails, etc.

- This may result in electric shock or injury.

Do not wash laundry contaminated by oils, creams, or lotions usually found in skincare shops, hair salons or massage clinics.

- This may result in the rubber seal becoming deformed and water leakage.

Do not leave metal objects (safety pins, hair pins, etc.) or bleach in the tub for long periods of time.

- This may cause the tub to rust.
- If rust appears on the surface of the tub, apply a neutral cleansing agent to the surface and use a sponge to clean it. Never use a metal brush.

Do not use dry cleaning detergent in the tub and do not wash, rinse, or spin laundry contaminated by dry cleaning detergent.

- This may result in spontaneous combustion or ignition due to heat from the oxidation of the oil.

Do not use hot water from water cooling/heating devices.

- This may result in problems with the washer.

Do not use natural hand-washing soap in the washer.

- If it hardens and accumulates inside the washer, it may cause problems with the product, discoloration, rust, or bad odors.

SAVE THESE INSTRUCTIONS

Do not wash large laundry items such as bedding in the washing net.

- Failing to do so may result in injury due to abnormal vibrations.
- Place smaller items, such as lace socks and lingerie in the washing net.

Do not use hardened detergent.

- If it accumulates inside the washer, it may result in water leakage.

Do not wash throw rugs or doormats in the washer.

- If you wash throw rugs or doormats, the sand will accumulate inside the washer. It may result in error such as no draining.

Critical cleaning warnings

WARNING

Do not clean the appliance by spraying water directly onto it.

Do not use a strong acid cleaning agent.

Do not use benzene, paint thinner, or alcohol to clean the appliance.

- This may result in discoloration, deformation, damage, electric shock, or fire.

Before cleaning or performing maintenance, unplug the appliance from the wall socket.

- Failing to do so may result in electric shock or fire.

SAVE THESE INSTRUCTIONS

Regulatory notice

FCC Notice

CAUTION

Any changes or modifications not expressly approved by the party responsible for compliance could void the user's authority to operate the equipment.

This device complies with Part 15 of FCC Rules. Operation is Subject to following two conditions:

1. This device may not cause harmful interference, and
2. This device must accept any interference received including interference that cause undesired operation.

For products sold in the US and Canadian markets, only channels 1–11 are available. You cannot select any other channels.

FCC STATEMENT:

This equipment has been tested and found to comply within the limits for a Class B digital device, pursuant to part 15 of the FCC Rules. These limits are designed to provide reasonable protection against harmful interference in a residential installation.

This equipment generates, uses, and can radiate radio frequency energy and, if not installed and used in accordance with the instructions, may cause harmful interference to radio communications. However, there is no guarantee that interference will not occur in a particular installation. If this equipment does cause harmful interference to radio or television reception, which can be determined by turning the equipment off and on, the user is encouraged to try to correct the interference by one or more of the following measures:

- Reorienting or relocating the receiving antenna
- Increasing the separation between the equipment and receiver
- Connecting the equipment to an outlet that is on a different circuit than the radio or TV.
- Consulting the dealer or an experienced radio/TV technician for help.

FCC RADIATION EXPOSURE STATEMENT:

This equipment complies with FCC radiation exposure limits set forth for an uncontrolled environment. This equipment should be installed and operated so there is at least 8 inches (20 cm) between the radiator and your body. This device and its antenna(s) must not be colocated or operated in conjunction with any other antenna or transmitter.

SAVE THESE INSTRUCTIONS

IC Notice

The term “IC” before the radio certification number only signifies that Industry Canada technical specifications were met. Operation is subject to the following two conditions:

1. This device may not cause interference, and
2. This device must accept any interference, including interference that may cause undesired operation of the device.

This Class B digital apparatus complies with Canadian ICES-003.

Cet appareil numérique de la classe B est conforme à la norme NMB-003 du Canada.

For products sold in the US and Canadian markets, only channels 1–11 are available. You cannot select any other channels.

IC RADIATION EXPOSURE STATEMENT:

This equipment complies with IC RSS-102 radiation exposure limits set forth for an uncontrolled environment. This equipment should be installed and operated so there is at least 8 inches (20 cm) between the radiator and your body. This device and its antenna(s) must not be colocated or operated in conjunction with any other antenna or transmitter.

SAVE THESE INSTRUCTIONS

Regulatory notice

Open Source Announcement

The software included in this product contains open source software.

The following URL http://opensource.samsung.com/opensource/SMART_TP1_0/seq/0 leads to open source license information as related to this product.



To turn on the Wi-Fi connection for your washing machine

The Wi-Fi network is automatically connected when the washing machine starts operation. To manually control the Wi-Fi connection, press and hold **Temp.** and **Smart Control** for simultaneously 3 seconds to toggle the Wi-Fi connection on or off.

- The number 1 indicates the Wi-Fi connection is on while 0 refers to disconnection.

SAVE THESE INSTRUCTIONS

Installation

Follow these instructions carefully to ensure proper installation of your washer and to prevent accidents when using it.

⚠ WARNING

Certain internal parts are intentionally not grounded and may present a risk of electric shock only during servicing. Service personnel – Do not contact the following parts while the appliance is energized: Control board, heat sink, motor, inlet valve, heater and pump.

Unpacking your washer

Unpack your washer and inspect it for shipping damage. Make sure you have received all the items shown on the next page. If your washer was damaged during shipping, or you do not have all of the items, call 1-800-726-7864 (1-800-SAMSUNG).

To prevent personal injury or strain, wear protective gloves whenever lifting or carrying the unit.

⚠ WARNING

Packing materials can be dangerous to children; Keep all packing material (plastic bags, polystyrene, etc.) well out of children's reach.

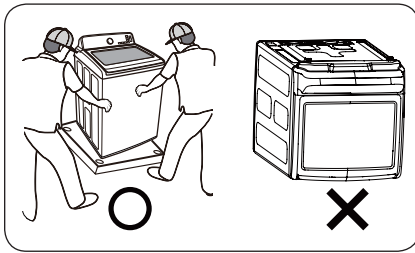

⚠ CAUTION

You must have at least 2 people unpack the washer. To remove the cushion bottom of the packing materials, do not tip the washer over on its front side.

When you lay the washer down to remove the carton base, protect the side of the washer and lay it down carefully. Never lay your washer on its back or front.

Installation

What's included

Make sure all the parts are included in the product package. If you have a problem with the washer or the parts, contact the Samsung customer care center at 1-800-SAMSUNG (1-800-726-7864) or your retailer.

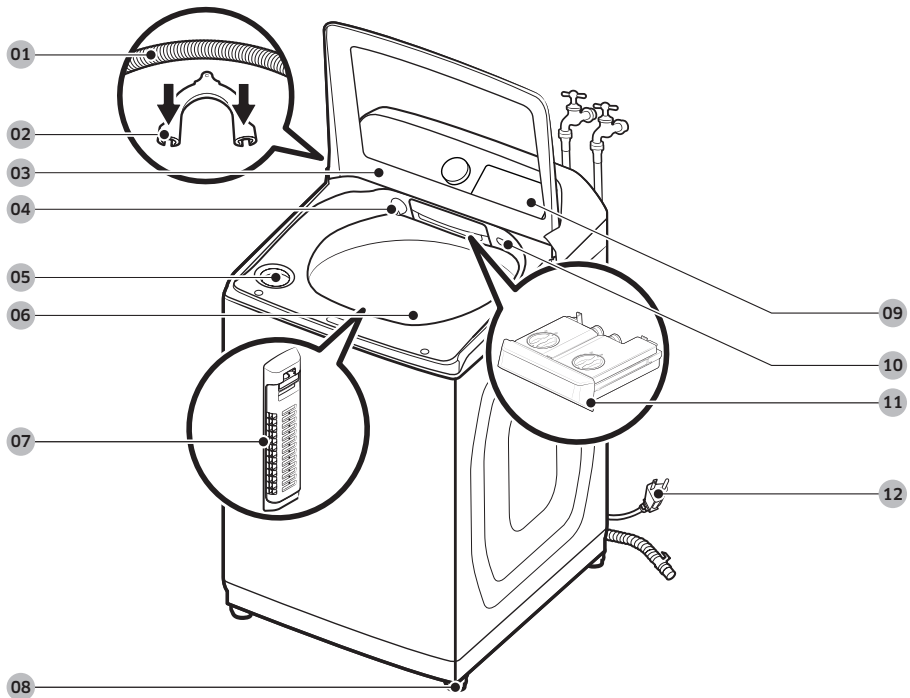

01 Drain hose

02 Hose guide

03 Lid

04 Active Waterjet nozzle

05 Bleach compartment

06 Tub

07 Pet hair filter (applicable models only)

08 Leveling feet

09 Control panel

10 Active Waterjet button

11 Detergent drawer

12 Power cord

Parts supplied

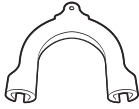

Hose guide

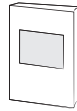

User manual

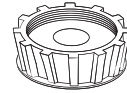

Water intake cap



Cable tie

Parts not supplied

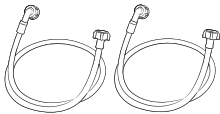

Water hoses

Tools needed for installation



Wrench

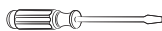

Phillips
screwdriver



Level



Adjustable pliers

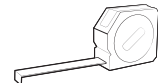

Measuring tape

NOTE

- If you lose an accessory and want to purchase a replacement, contact the Samsung customer care center at 1-800-SAMSUNG (1-800-726-7864).
- The design of the parts and accessories may differ from the pictures above. Their design is subject to change without notice for product improvement.

CAUTION

- Do not reuse old water hoses, which may leak or burst, causing flooding and/or property damage.
- Make sure rubber washers are inserted in each coupling of both water hoses.

Installation

Installation requirements

Electrical supply and grounding

- AC 120 V / 60 Hz / 15 AMP fuse or circuit breaker is required.
- Use an individual branch circuit. Connect only the washer to the circuit.

To ensure proper grounding, the washer comes with a power cord featuring a three-prong grounding plug for use in a properly installed and grounded outlet.

Check with a qualified electrician or service person if you are not sure about the grounding.

Do not modify the provided plug. If it does not fit the outlet, call a qualified electrician to install a proper outlet.

WARNING

- Do NOT use an extension cord.
- Use only the power cord that comes with the washer.
- Do NOT connect the ground wire to plastic plumbing, gas lines, or hot water pipes.
- Improperly connected grounding conductors may cause electric shock.
- To prevent unnecessary risk of fire, electrical shock, or personal injury, all wiring and grounding must be done in accordance with local codes, or in the absence of local codes, in accordance with the National Electrical Code, ANSI/NFPA No. 70-Latest Revision (for the U.S.) or the Canadian Electrical Code CSA C22.1 – Latest Revisions and local codes and ordinances. It is your responsibility to provide adequate electrical service for your washer.

Water supply

Proper water pressure for this washer is between 20-116 psi (137-800 kPa). Water pressure less than 20 psi (137 kPa) may cause the water valve not to close completely, or it may take longer to fill the drum, causing the washer to turn off. Water taps must be within 4 ft. (122 cm) from the rear of the washer so that the provided inlet hoses reach the washer.

To reduce the risk of leaks:

- Make sure water taps are easily accessible.
- Turn off the taps when the washer is not in use.
- Check for any leaks at the water inlet hose fittings on a regular basis.

CAUTION

Before using the washer for the first time, check all connections at the water valve and taps for any leaks.

Drain

Samsung recommends a standpipe 39 in. (990 mm) high. The drain hose must be connected through the hose clip to the standpipe, and the standpipe must fully cover the drain hose.

Flooring

For best performance, the washer must be installed on a solid floor. Wood floors may need to be reinforced to minimize vibration and/or unbalanced loads. Carpeting and soft tile surfaces do not provide good resistance to vibrations and may cause the washer to move slightly during the spin cycle.

⚠ CAUTION

Do NOT install the washer on a platform or a poorly supported structure.

Water temperature

Do not install the washer in areas where water may freeze as the washer always retains some water in its water valves, pumps, and/or hoses. Frozen water can cause damage to belts, the pump, and other components of the washer.

Dimensions

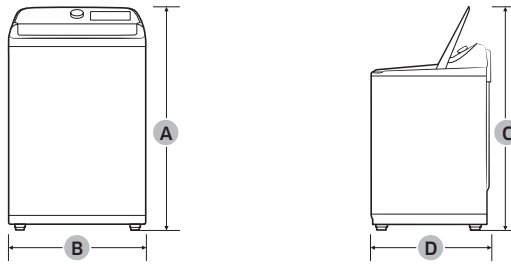

A. Height	45.8 in. (1163 mm)
B. Width	27.5 in. (699 mm)
C. Height with lid open	59.5 in. (1511 mm)
D. Depth	29.4 in. (747 mm)

Installation

Clearance requirement

This clearance requirement is applicable for washers only.

NOTE

- For the dryer's clearance requirement, see the dryer's user manual.
- If the washer and dryer have different clearance requirements, use the one with the larger value.

Alcove or closet installations

Minimum clearance for stable operation:

Sides	Top	Rear	Front
1 in. / 25 mm	21 in. / 533 mm	5.9 in. / 150 mm	1 in. / 25 mm

If both the washer and a dryer are installed in the same location, the front of the alcove or closet must have two unobstructed air openings for a combined minimum total area of 72 in.² (465 cm²).

This clearance requirement is applicable for washer and dryer pair installation.

Side by side installation

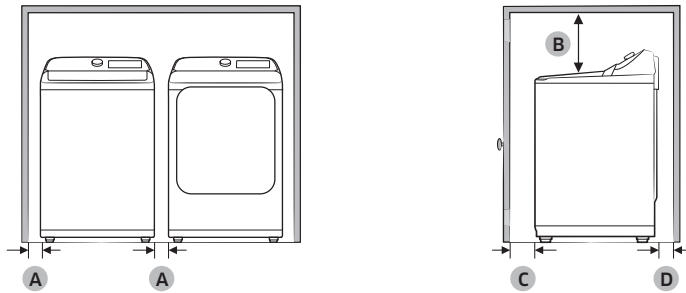

A	1 in. (25 mm)
B	21 in. (533 mm)
C	1 in. (25 mm)
D	5.9 in. (150 mm)

Step-by-step installation

STEP 1 Select a location

Location requirements:

- A solid, level surface without carpeting or flooring that may obstruct ventilation
- No direct sunlight
- Adequate room for ventilation and wiring
- Ambient temperature always higher than the freezing point (32 °F / 0 °C)
- Away from heat sources

STEP 2 Connect the water hose

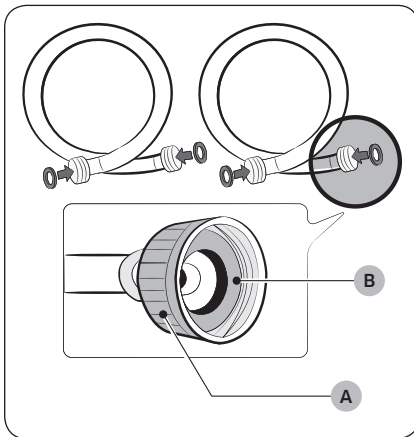

⚠ CAUTION

- Make sure to use new water hoses and that **rubber gaskets (B)** are inside the **couplings (A)** at both ends of the hoses. Water hoses without the gaskets may leak.
- Allow 6 in. (150 mm) of space between the back of the washer and the wall to prevent water hoses from being kinked. Kinked hoses may cause water leaks.
- If there is a water leak, stop using the washer and contact a local Samsung service center. A water leak may cause electric shock.
- Do not stretch the water hoses by force. If a hose is too short, replace the hose with a longer hose.

Installation

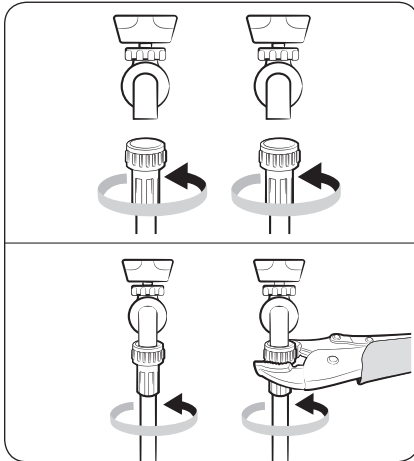

1. Attach the water hoses to the hot and cold water taps, and then hand tighten the water hose fittings until they are tight. Then, use pliers to tighten the fittings by an additional two-thirds of a turn. To avoid damaging the fittings, do not overtighten them.
2. Pull the water hoses to check if they are firmly connected.

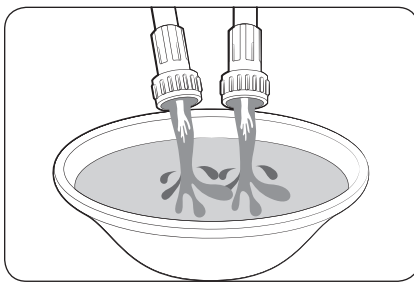

3. Put the other ends of the hoses into a bucket, and then open the water taps for 10 - 15 seconds to remove impurities. When done, close the taps.

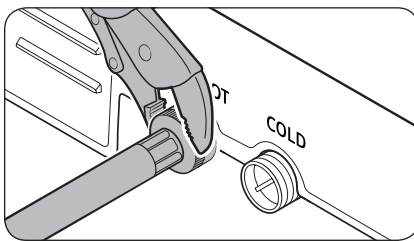

4. Attach the water hoses to the hot and cold water inlets on the back of the washer, and then hand tighten the water hose fittings until they are tight. Then, use pliers to tighten the fittings by an additional two-thirds of a turn.

NOTE

- If you are not going to use the hot water, block the hot water supply intake with the water intake cap. Otherwise, there is a risk of water leak.
- Make sure to set the water temperature to Cold after blocking the hot water supply intake. Otherwise, the amount of supplied water could be low, or the water could not supply at all.

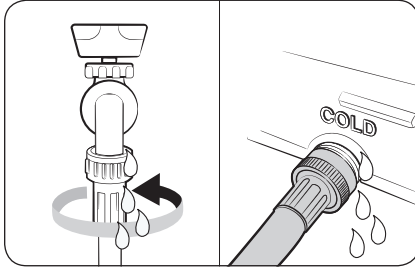

5. Open the water taps, and check for leaks.

STEP 3 Connect the drain hose

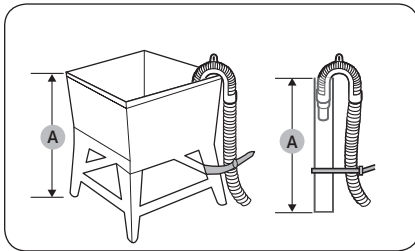

To a Laundry Tub or Drain Pipe

1. Check the **height (A)** of your drain system and make sure the minimum and maximum heights shown below are met.

Minimum	39 in. (99 cm)
Maximum	96 in. (245 cm)

NOTE

- Make sure to measure the height from the floor where the washer is placed.
- Draining efficiency may be reduced if the drain system is at the maximum height.
- To prevent the washer from siphoning water, do not use a drain system below the minimum height.

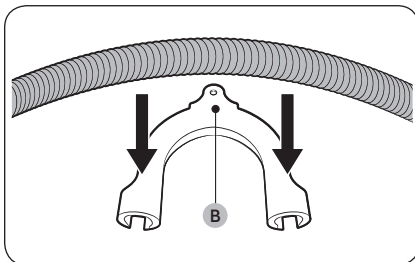

2. Attach the drain hose to the **plastic hose guide (B)**.

Installation

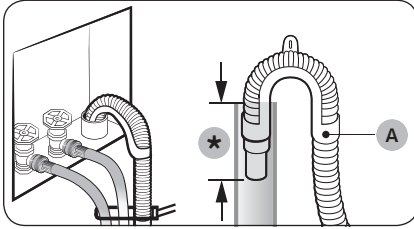

(*): Min. 6 in. (152 mm), Max. 8 in. (203 mm)

3. Route the drain hose to the drain system.

⚠ CAUTION

- If using a standpipe, make sure the standpipe and drain hose connection is not airtight.
 - If using a standpipe, make sure the drain hose is inserted at least 6 in. (152 mm) but no more than 8 in. (203 mm) into the standpipe.
4. Secure the drain hose with cable ties.

STEP 4 Level the washer

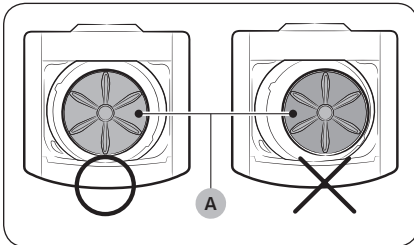

1. Slide the washer into position.
2. Open the lid of the washer, and then pour water into the tub until the blades of the pulsator on the bottom of the washer are about half covered.
3. If the washer is level, the **pulsator (A)** will be positioned at the center of the tub as shown in the figure and the water will appear level in the tub. That is, the water will reach the same height on all sides of the tub.

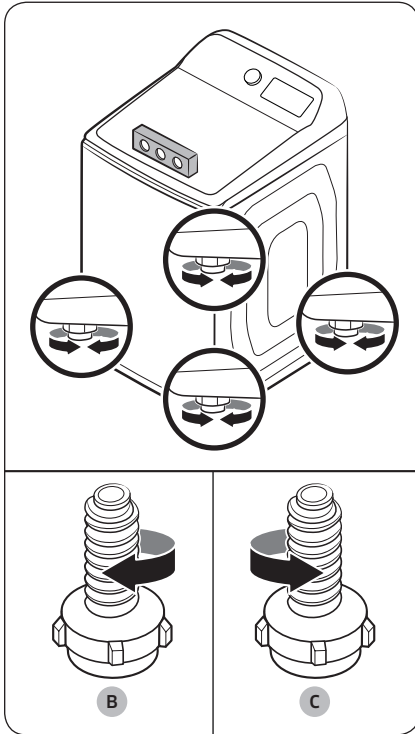

4. If the washer is not level, turn the appropriate leveling feet **clockwise (B)** to lower the washer, or **counterclockwise (C)** to raise the washer so that it is level.
5. Once you have the washer leveled, push down on all 4 corners to ensure that all 4 feet are touching the floor. If the washer rocks when you push down on a corner, adjust the leveling foot at that corner so the foot is firmly on the floor.

NOTE

- You can also level the washer by lining a level up with the seam that runs between the top of the washer and the body of the washer and checking if the washer is level on all 4 sides.
- See the diagram above, left. After you have checked all 4 sides and leveled the washer, perform Step 5 above.

Installation

Leveling the washer with the leg ring (For WA5*A730*A* models only)

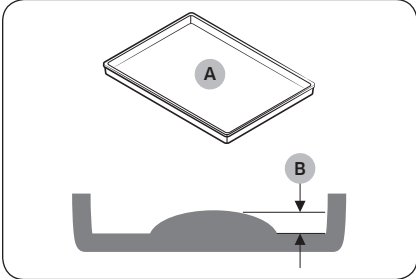

- A. Water drip pan
- B. Bulge height less than 5/8"

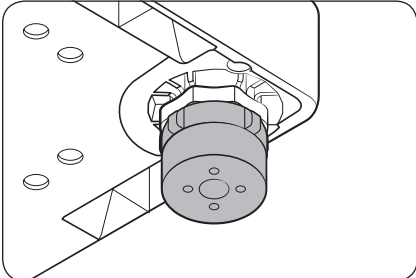

With the leg ring in place, use the leveling leg to adjust the height of the washer.

STEP 5 Power on

Plug the power cord into an AC 120 V / 60 Hz / 15 AMP approved electrical outlet protected by a 15-amp fuse or circuit breaker. Then, press **Power** to turn on the washer.

STEP 6 Run a test cycle

Run a test cycle as follows to check if your washer is properly installed.

1. Load about 6 lb. of laundry into the tub.
2. Press **Power** to turn on your washer.
3. Turn the **Cycle Selector** to **RINSE+SPIN**.
4. Press and hold **Start/Pause (Hold to Start)** to start the test cycle.
5. The washer should not rock or vibrate excessively when water is supplied or when washing and spinning, and should drain well during the spin cycle.

NOTE

- If water leaks while water is being supplied or drained, check the water connections. See “**Connect the water hose**” on page 21.
- If the washer rocks and vibrates excessively, level your washer again. See “**Level the washer**” on page 24.

Before you start

Initial settings

Run Calibration (recommended)

Calibration ensures accurate weight detection by the washer. Make sure the tub is empty before running calibration.

1. Press **Power** to turn on the washer.
2. Press and hold **Temp.** and **Delay End** simultaneously for 3 seconds.
3. Press and hold **Start/Pause (Hold to Start)** to start calibration.
 - The tub rotates clockwise or counterclockwise for approximately 2 minutes.
4. When complete, "0" appears on the display, and the washer turns off automatically.

Laundry guidelines

STEP 1 Sort

Sort the laundry according to these criteria:

- Care label: sort the laundry into cottons, mixed fibers, synthetics, silks, wools, and rayon.
- Color: Separate whites from colors.
- Size: Mixing different sized items together in the tub improves washing performance.
- Sensitivity: Wash delicate items separately. For pure new woolen items, curtains, and silk items, check the labels on the items.

NOTE

Make sure to check the care label on all clothing, and sort clothing accordingly before starting the wash.

STEP 2 Empty pockets

Empty all the pockets of your laundry items

- Metal objects such as coins, pins, and buckles on clothing may damage other laundry items as well as the tub.

Turn clothing with buttons and embroideries inside out

- If pants or jacket zippers are open while washing, the tub may be damaged. Zippers should be closed and fixed with a string.
- Clothing with long strings may become entangled with other clothes. Make sure to tie the strings before starting the wash.

STEP 3 Use a delicates bag

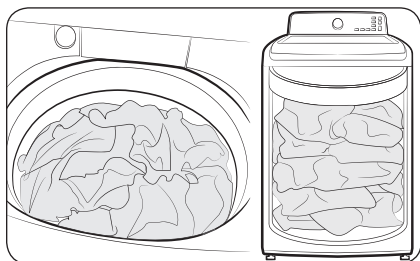

WA**CG7**0**

- Brassieres (water washable) must be placed in a delicates bag. Metal parts of the brassieres may break through and tear other laundry items.
- Cashmilon, large volume items, and lightweight clothes (lace-decorated clothes, lingerie, nylon stockings, and synthetic fabrics) may float during washing and not wash properly. Use the delicates bag or wash them separately.
- Do not wash the delicates bag by itself without other laundry. This can cause abnormal vibrations that could cause the washer to move and result in injury.

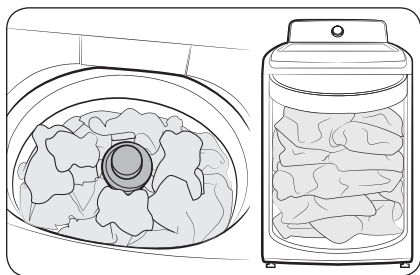

WA**CG7**5**

⚠ CAUTION

Make sure to soak inflatable items (such as blankets, and cotton-filled or microfiber quilts) in water before you run a cycle.

- Inflatable items may damage the laundry or the washer during the washing or spinning process.
- Regardless of the size, it is safer to wash blankets or quilts one item at a time. This will also get them cleaner. Two different-sized blankets in the same load can cause the load to become unbalanced, compromising the spinning process.

Before you start

To put a blanket in your washer

Fold the blanket as shown, and then put it below the **plastic ring (A)** at the top of the tub.

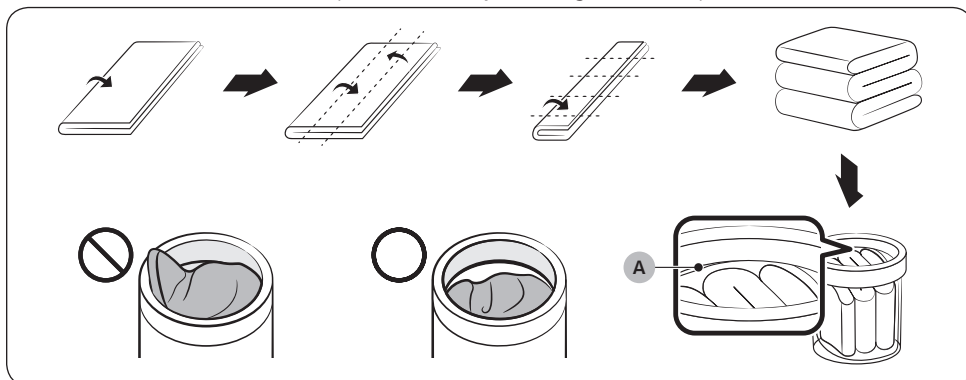

NOTE

Do not wash different types of bedding (blankets, sheets, comforters/duvets) together. They can get unbalanced in the tub and cause poor spinning results.

- Separate the beddings by their type before washing.
 - If an item is bulky and absorbs large amounts of water during washing, wash that item individually.
 - Do not wash light items with items that hardly absorb water together.
 - Do not wash duvets or comforters with their covers or bed sheets.

STEP 4 Prewash (if necessary)

- To remove stains and dirt on collars, sleeves, hems, and pockets, apply detergent lightly, let sit for a minute, and then brush off carefully.
- Use powder or liquid detergents. Do not use soap. Soap can remain on the tub after washing.
- To prewash white socks, sleeves, and collars apply a little detergent, and then brush carefully.

CAUTION

Make sure the laundry is inserted completely.

- Any exposed part of the laundry can cause damage to the washer or the laundry itself or cause a water leak.
- Make sure the laundry does not extend past the plastic ring at the top of the tub.

STEP 5 Determine the load capacity

Make sure the laundry does not extend past the plastic ring at the top of the tub. If it does, it can cause the washing machine to wash improperly or cause damage to the washer or the laundry itself or cause a water leak.

NOTE

When washing bedding or bedding covers, the wash time may be lengthened or the spin efficiency may be reduced.

For bedding or bedding covers, the recommended load capacity is 7.5 lb (3.5 kg) or less.

CAUTION

If the laundry is unbalanced and the “**UB**” information code is displayed, redistribute the load. Unbalanced laundry can reduce spinning performance.

Before you start

STEP 6 Add the correct detergent type

The type of detergent you use - general purpose, specifically for woolens, etc. - depends on the type of fabric (cotton, synthetic, delicate items, wool), color, wash temperature, and degree of soiling. Regardless of the specific type of detergent you use, always use “low suds” HE laundry detergent which is designed for automatic washers.

NOTE

- Follow the detergent manufacturer’s recommendations based on the weight of the laundry, the degree of soiling, and the hardness of the water in your local area. If you are not sure about the water hardness, contact your local water authority.
- Do not use detergent that tends to harden or solidify. This detergent may remain in the washer after the rinse cycle, blocking the drain outlet.

Use HE detergent only



- For the best cleaning results, use a high efficiency detergent such as Tide HE, Wisk HE, Cheer HE or Gain HE*. High efficiency detergents contain suds suppressors that reduce or eliminate suds. When fewer suds are produced, the load tumbles more efficiently and cleaning is maximized. (*Brand names are trademarks of their respective manufacturers.)

WARNING

For best results, use HE detergents only. Do not use non-HE detergent, organic detergent, natural detergent or HE detergents with natural ingredients (such as vinegar, baking soda).

Detergent drawer guidelines

The automatic dispenser models has two compartments for auto-dispensing. See below for details:

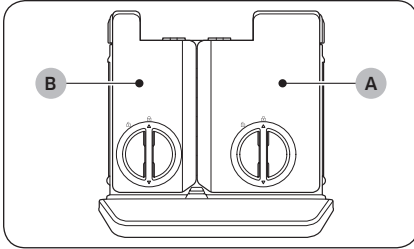

A. Auto detergent compartment:

Use liquid detergent only.

B. Auto softener compartment:

Use fabric softener only.

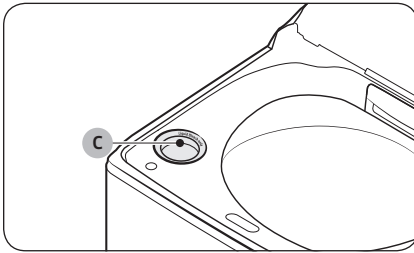

C. Bleach compartment: Add bleach as instructed by the manufacturer.

NOTE

Do not pour color-safe bleach into the bleach compartment.

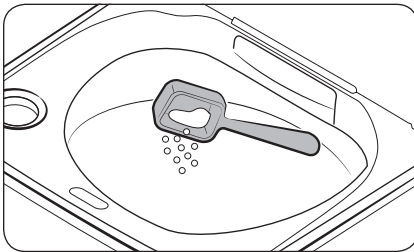

NOTE

If you need to put detergent (liquid, powder, or pellet) manually, put it directly into the tub.

- If you use powder detergent, put detergent into the tub before putting your laundry.

CAUTION

- The **Softener or Detergent** button's LED blinks when the detergent or softener level is low.
- Do not add an excessive amount of detergent. This may affect the washing results adversely.
- Do not use any cleaning agents for cleaning the drum. Chemical residue in the drum deteriorates the washing performance.
- Do not use the following types of detergent in the drawer.
 - Tablet, capsule, ball, or net types.
- Do not use gel-type or viscous detergent/softener in the detergent drawer as they may not flow well.
 - Read the detergent/softener manufacturer's instructions before using them in the washer.

Before you start

- Empty the compartments in the detergent drawer before moving the washer to prevent any content from spilling out on the floor.

NOTE

- The “SDC” message appears if the detergent drawer is not completely closed. You will hear a click sound when the drawer is properly closed. Close the detergent drawer until it clicks before you start the washer.
- If the **Softener** or **Detergent** button's LED blinks, refill the corresponding compartment.
- Do not exceed the max line when filling detergent and softener.
- It may be hard to open the detergent drawer with just your fingertips. Grab the detergent drawer handle firmly with your hand and pull to open it.
- Push the detergent drawer all the way to the end to close it. You will hear a click sound when the drawer is properly closed.
- If you feel softener scent is weak, set the softener input level to High.
- Using a water softener (such as borax) in hard water can prevent fabric damage and discoloration. Do not pour into the auto detergent dispenser. Pour manually into the machine.

To use the bleach compartment

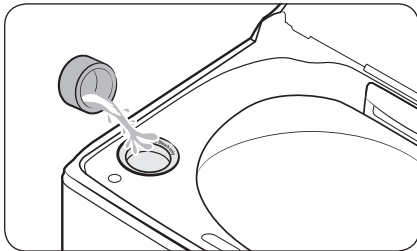

Add only liquid chlorine bleach to the bleach compartment. Do not exceed the max line.

CAUTION

Do not add undiluted liquid chlorine bleach directly to the load or to the tub. This may cause fabric damage.

To apply washing agents to the auto dispenser

NOTE

- If the **Softener** or **Detergent** button's LED blinks, refill the corresponding compartment.
- Once you refill the auto detergent/softener compartments, the washer will start to detect the detergent/softener amount when you press and hold **Start/Pause (Hold to Start)**.
 - The detection time may vary depending on the type of the detergent/softener.

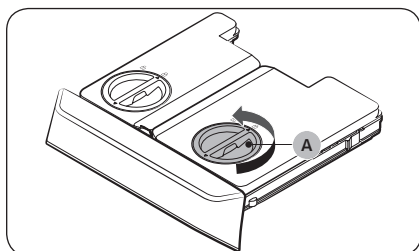

1. Pull the detergent drawer to open.
2. Turn the **auto detergent compartment cover (A)** counter-clockwise to open.

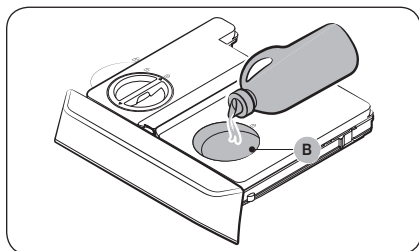

3. Apply an appropriate amount of detergent to the **auto detergent compartment (B)**. Pour detergent slowly to prevent overfilling.
 - After you finish, put the cover back and turn it clockwise to close.

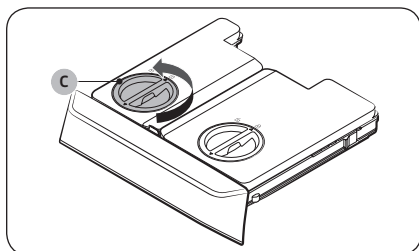

4. Turn the **auto softener compartment cover (C)** counter-clockwise to open.

Before you start

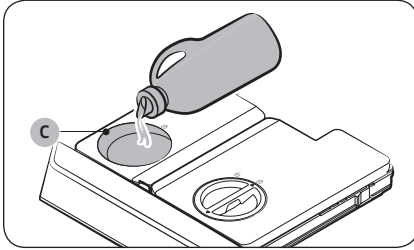

5. Apply an appropriate amount of fabric softener to the **auto fabric softener compartment (D)**. Pour fabric softener slowly to prevent overfilling.
 - After you finish, put the cover back and turn it clockwise to close.
6. Push the detergent drawer to close.
 - Push the detergent drawer all the way to the end. You will hear a click sound when the drawer is properly closed.

⚠ CAUTION

- Do not apply detergent/softener to the drawer without the detergent/softener compartment.
 - If you do, clean the drawer and then reinsert both compartments.
- Use only liquid detergent/softener with the detergent/softener compartments. Do not use powder detergent.
- Do not insert detergent/softener to the drawer without the detergent and softener compartments inserted. If you apply detergent/softener to the drawer, clean the drawer and reinsert both compartments.
 - If they are not, the washer may not start operating or fail to dispense washing agents.
- Clean the detergent/softener compartment before refilling them with the same or a different type of detergent or softener.
- If you are not going to use the washer for a long time (over a month), empty the detergent/softener compartments and clean them thoroughly.
- If you have accidentally mixed the detergent and softener in one of the compartments, empty the compartment, clean them thoroughly, and put the correct cleaning agent in its compartment.
- To prevent detergent/softener from hardening, do not open the cover once the detergent/softener has been applied to the compartment.
- Do not use any bleach that may cause corrosion and/or generate the gas.
- Do not turn any compartment upside down.
 - The content may spill.
- Do not press the outlet at the rear of either compartment while moving it.
 - The content may leak.
- Use caution when inputting detergent or fabric softener in the applicable compartment.
 - The content may spill.
- When removing the detergent/softener compartment to check the remaining content (upon an error message or before the message appears), the drawer may have content remaining or leaking from the bottom of the drawer.
- Make sure all the compartments in the detergent drawer are empty before moving the washer.
- The input or refill level of the detergent/softener depends on the type or the remaining amount of detergent/softener.
- If the **Softener** or **Detergent** button's LED blinks, immediately refill the corresponding compartment. A later refill may cause the input level of the agent to decrease.

-
- Do not use hardened detergent/softener.
 - When you take out the detergent drawer for refill and cleaning, residual detergent may remain inside each compartment. This occurs after automatic dispensing and is not an issue with operation.

 **NOTE**

- Use detergent and bleach for washer only.
- Do not put organic, natural, or handmade laundry detergent/softener into the Auto detergent/softener compartment, as they may not be detected properly by the washing machine.
- Do not use gel-type or viscous detergent/softener in the detergent drawer as they may not flow well.
 - Read the detergent/softener manufacturer's instructions before using them in the washer.
- When you need to refill the detergent or softener compartment, we recommend refilling the compartment after removing the detergent drawer from the washer.
- Detergent/softener is not automatically dispensed in the WOOL, DELICATES, and ACTIVEWEAR cycles. To dispense detergent/softener in the WOOL, DELICATES, and ACTIVEWEAR cycles, you must manually set the input level of detergent/softener.

Operations

⚠ WARNING

To reduce the risk of fire, electric shock, or injury to persons, read the **Safety information** before operating this appliance.

Control panel

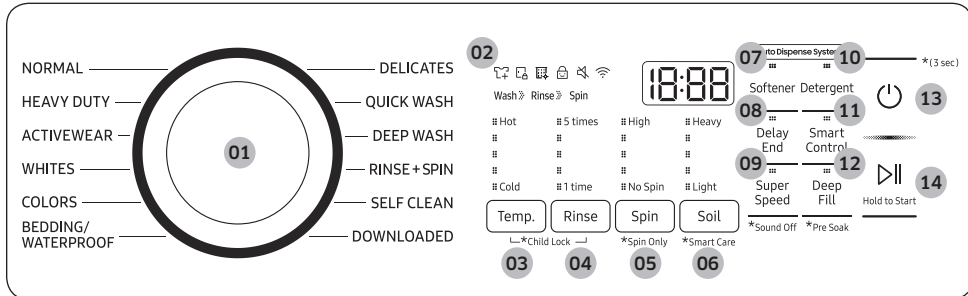

WA55CG7500**

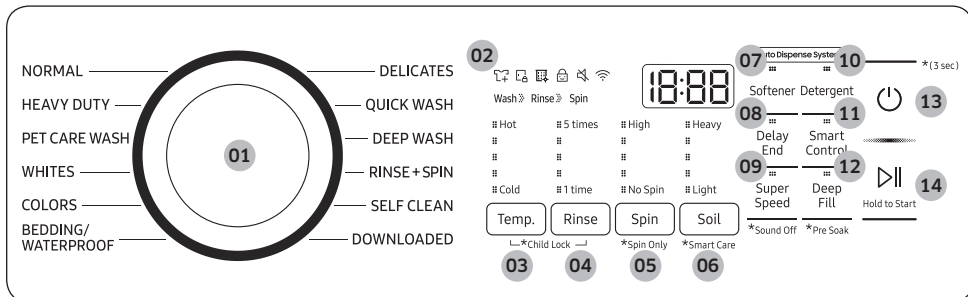

WA54CG7550**









01 Cycle Selector	Turn the dial to select a cycle. (For more information about wash cycles, see page 44.)
02 Display	The display shows current cycle information and estimated time remaining, or an information code if the washer needs to be checked.
03 Temp.	Press to change the water temperature for the current cycle. <ul style="list-style-type: none"> • Hot (Level 5): Whites and heavily soiled, colorfast items. • (Level 4): Warm temperature for colorfast items. • (Level 3): Moderately soiled, colorfast items; most wrinkle-free items. • Cool (Level 2): Brightly colored, very lightly soiled items. • Cold (Level 1): No warm water is supplied.
04 Rinse	Press to change the rinse count for the current cycle.

05 Spin	<p>Press to change the spinning speed for the current cycle.</p> <ul style="list-style-type: none"> • High (Level 5): Extends the spinning process to effectively remove moisture from the load. This level uses a stronger spinning process to remove moisture, so it is not suitable for wrinkle-free or non-iron fabrics, or overloads. • (Level 4): Underwear, t-shirts, jeans, and sturdy cottons. • (Level 3): Jeans, wrinkle-free or wash-and wear items, and synthetics. • (Level 2): Delicate items that require a lower spinning speed. • No Spin (Level 1): The drum does not spin after the final drain process. <p>Rinse hold (All indicators are off): The final rinse process is suspended so that the laundry remains in the water. To unload the laundry, run a drain or spin cycle.</p> <p>Spin Only: To run the Spin Only cycle, press Spin for 3 seconds. When the cycle time and spinning speed appear, press Spin repeatedly until a desired spinning speed is selected. Then, press and hold Start/Pause (Hold to Start) to start the cycle. The spinning time depends on the selected cycle.</p>
06 Soil	<p>Press to change the soil level for the current cycle.</p> <ul style="list-style-type: none"> • Heavy (Level 5): For extremely soiled loads. • (Level 4): For heavily soiled loads. • (Level 3): For moderately soiled loads. This setting is best for most loads. • (Level 2): For lightly soiled loads. • Light (Level 1): For barely soiled loads.
07 Softener	<p>The washing machine adjusts the amount of fabric softener to dispense.</p> <p> NOTE</p> <p>If the LED blinks, immediately refill the softener. A later refill may cause the input level of the agent to decrease.</p>
08 Delay End	<p>Set the washer to finish your wash automatically at later time. Choose a delay of between 1 to 24 hours (in 1 hour increments). (For more information about Delay End, see page 47.)</p>
09 Super Speed	<p>Press to shorten the washing time of the NORMAL, HEAVY DUTY, PET CARE WASH or WHITES cycles. Shortened time may differ depending on the cycle, load, and options.</p>
10 Detergent	<p>The washing machine adjusts the amount of detergent to dispense.</p> <p> NOTE</p> <p>If the LED blinks, immediately refill the detergent. A later refill may cause the input level of the agent to decrease.</p>

Operations

11 Smart Control	After connecting the washer to your home network using the SmartThings app, you can control the washer remotely. When started, the Smart Control indicator blinks and the front door locks. The washer enters waiting mode and waits for remote commands. (For more information about Smart Control, visit the SmartThings app page.)
12 Deep Fill	Use this option where extra water is needed. NOTE <ul style="list-style-type: none"> • Cycle time will be extended when you use this option. • This option is not available for NORMAL wash cycle. Enabling this option in the NORMAL wash cycle will automatically change the wash cycle to DEEP WASH.
13 Power	Press to turn the washer on or off.
14 Start/Pause (Hold to Start)	Press and hold to start operation or press to stop operation temporarily.

Icon description

	Garment+	<ul style="list-style-type: none"> • This icon indicates you can add or take out items after a cycle has started. • To add or take out items, press Start/Pause (Hold to Start) to pause the cycle, and then open the lid. To resume the cycle, close the lid, and then press and hold Start/Pause (Hold to Start).
	Lid Lock	<ul style="list-style-type: none"> • This icon indicates the lid is locked and cannot be opened. • The lid locks automatically during a cycle and this indicator turns on. • You can open the lid when this icon disappears.
	SELF CLEAN reminder	<ul style="list-style-type: none"> • This icon indicates that you should clean the drum using the SELF CLEAN cycle. • After every 20 cycles, this icon appears for an hour and then turns off automatically. The icon will appear for 5 more cycles, turn off, and then will not appear for another 20 cycles.
	Child Lock	<ul style="list-style-type: none"> • This icon indicates that Child Lock is on. • For more information about Child Lock, see page 48.
	Sound Off	<ul style="list-style-type: none"> • This icon indicates that the sound is off
	Wi-Fi	<ul style="list-style-type: none"> • This icon indicates that the washer is connected to Wi-Fi.

Simple steps to start

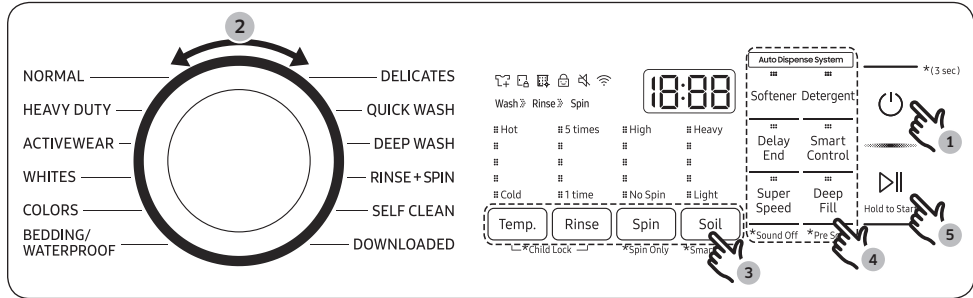

1. Press **Power** to turn on the washer.
2. Turn the **Cycle Selector** to select a cycle.
3. Change the cycle settings (**Temp.**, **Rinse**, **Spin**, and **Soil**) as necessary.
4. Select desired options as necessary.
5. Press and hold **Start/Pause (Hold to Start)**.

To change the cycle during operation

1. Press **Start/Pause (Hold to Start)** to stop operation.
2. Select a different cycle, and repeat steps 2-3 above if necessary.
3. Press and hold **Start/Pause (Hold to Start)** again to start the new cycle.

Operations

Cycle overview

NOTE

The washer detects the weight of the items and automatically adjusts the optimal water level, washing time, rinse counts, and spin counts. (This may not be applicable on some cycles.)

Cycle	Description
NORMAL	<ul style="list-style-type: none">For cottons, bed linens, table linens, underwear, towels, or shirts. The washing time and the number of rinses are automatically adjusted according to the load.
HEAVY DUTY	<ul style="list-style-type: none">For sturdy, colorfast fabrics, heavily soiled items.
PET CARE WASH (WA54CG7550**)	<ul style="list-style-type: none">For cleaning pet-related items and clothes.This cycle is set to use high-temperature water as default. Therefore, it is recommended to wash items made of cotton. Wool, silk, lace, velvet, or dark-colored clothes may be deformed or discolored.For items with fillings, such as cushions, remove the fillings and wash only the covers. <p> CAUTION</p> <ul style="list-style-type: none">Remove the pet hair on items and clean the pet hair filter before every wash cycle to maximize the effectiveness of the cycle and prevent the pet hair from remaining in the tub, contaminating other items.There might be pet hair and foreign matter in the tub after completing the wash cycle. Remove foreign matter with a dry cloth.Do not wash pet-related items that contain hard or plastic materials, which can cause noise or damage the inside of the tub.Some old and tough stains and odors on the items may not be completely removed even after using this cycle.Do not wash pet-related items that contain electrical parts.
ACTIVEWEAR (WA55CG7500**)	<ul style="list-style-type: none">For exercise wear such as sports jerseys, training pants, shirts/tops and other performance clothing. This cycle provides effective soil removal with gentle action for special fabric care.
WHITES	<ul style="list-style-type: none">For white items. You can wash with or without bleach.
COLORS	<ul style="list-style-type: none">Featuring additional rinses and reduced spinning to ensure that the laundry is washed gently and rinsed thoroughly.

Cycle	Description
BEDDING/WATERPROOF	<ul style="list-style-type: none"> For bulky and large items, such as comforters, blankets, and sheets, and waterproof or water resistant items. When washing comforters, use liquid detergent. <p>⚠ CAUTION</p> <ul style="list-style-type: none"> Do not wash waterproof items and non-waterproof items together. Check the specification label on each item to see if the item is waterproof. Use the BEDDING/WATERPROOF cycle for waterproof or water-resistant items such as plastic mats, ski pants, raincoats, and comforters which hardly absorb water.
DELICATES	<ul style="list-style-type: none"> For sheer fabrics, bras, lingerie (silk), and other handwash-only fabrics. For best performance, use liquid detergents.
QUICK WASH	<ul style="list-style-type: none"> For lightly soiled garments needed quickly. For best performance, recommended load is 4 lb. or lower.
DEEP WASH	<ul style="list-style-type: none"> Recommended for special caseloads, which requires more free water and not for typical wash loads. Use more water in washing and rinsing.
RINSE+SPIN	<ul style="list-style-type: none"> For loads that need rinsing and spinning only. You can also select this cycle for additional rinsing and spinning after running other cycles.
SELF CLEAN	<ul style="list-style-type: none"> Cleans the drum by removing dirt and bacteria from the drum. Perform once every 20 washes. Make sure the drum is empty.
DOWNLOADED	<ul style="list-style-type: none"> Select to choose from more cycles available on the SmartThings app on your smartphone. Available cycles: PERM PRESS, WOOL, ECO COLD, DENIM, POWER RINSE. Factory setting: PERM PRESS.

Operations

Cycle chart

Use this chart to set the best cycle and options for you laundry.

NOTE

Setting	Temp.	Rinse	Spin	Soil
● : factory setting	5: Hot (Level 5)	5: 5 times (Level 5)	5: High (Level 5)	5: Heavy (Level 5)
○ : can be selected	4: (Level 4)	4: (Level 4)	4: (Level 4)	4: (Level 4)
	3: (Level 3)	3: (Level 3)	3: (Level 3)	3: (Level 3)
	2: (Level 2)	2: (Level 2)	2: (Level 2)	2: (Level 2)
	1: Cold (Level 1)	1: 1 time (Level 1)	1: No Spin (Level 1)	1: Light (Level 1)

Cycle	Temp.					Rinse				
	5	4	3	2	1	5	4	3	2	1
NORMAL	○	●	○	○	○	○	○	○	○	●
HEAVY DUTY	●	○	○	○	○	○	○	○	○	●
PET CARE WASH (WA54CG7550**)	●	○	○	○	○	○	○	○	●	○
ACTIVWEAR (WA55CG7500**)	–	○	●	○	○	○	○	○	○	●
WHITES	●	○	○	○	○	○	○	○	●	○
COLORS	–	○	○	●	○	○	○	○	○	●
BEDDING/WATERPROOF	○	●	○	○	○	○	○	○	●	○
DELICATES	–	○	○	●	○	○	○	○	○	●
QUICK WASH	○	●	○	○	○	○	○	○	○	●
DEEP WASH	○	●	○	○	○	○	○	○	○	●
RINSE+SPIN	–	–	–	–	–	○	○	○	○	●
SELF CLEAN	●	–	–	–	–	–	–	–	●	–

Cycle	Spin					Soil				
	5	4	3	2	1	5	4	3	2	1
NORMAL	○	●	○	–	○	○	○	●	○	○
HEAVY DUTY	○	●	○	○	○	●	○	○	○	○
PET CARE WASH (WA54CG7550**)	○	●	○	○	○	●	○	○	○	○
ACTIVEWEAR (WA55CG7500**)	–	○	●	○	○	–	–	○	●	○
WHITES	○	●	○	○	○	●	○	○	○	○
COLORS	○	●	○	○	○	○	○	●	○	○
BEDDING/WATERPROOF	–	○	●	○	○	○	○	●	○	○
DELICATES	–	–	○	●	○	–	–	–	–	●
QUICK WASH	○	●	○	○	○	○	○	○	○	●
DEEP WASH	○	●	○	○	○	○	○	●	○	○
RINSE+SPIN	○	●	○	○	○	–	–	–	–	–
SELF CLEAN	–	–	●	–	–	–	–	–	–	–

Cycle	Options			
	Pre Soak	Fabric Softener	Deep Fill	Super Speed
NORMAL	○	○	–	○
HEAVY DUTY	○	○	○	○
PET CARE WASH (WA54CG7550**)	○	○	○	○
ACTIVEWEAR (WA55CG7500**)	○	○	○	–
WHITES	○	○	○	○
COLORS	–	○	○	–
BEDDING/WATERPROOF	○	○	–	–
DELICATES	–	○	○	–
QUICK WASH	–	○	○	–
DEEP WASH	○	○	○	–
RINSE+SPIN	–	○	○	–
SELF CLEAN	–	–	–	–

Operations

Special features

Active Waterjet (for prewash)



You can use the Active Waterjet function to hand-wash your items before you put them in the washer.

1. Press **Power** to turn on your washer.
2. Open the lid.
3. Press **Active Waterjet** to supply water.
4. Hand-wash the items.
5. When done, press **Active Waterjet** again to stop the water.

NOTE

If you want to hand-wash while the washer is operating, press **Start/Pause (Hold to Start)** to stop operation, and then follow steps 1-4 above.

NOTE

- The Active Waterjet function stops operating automatically when the washer detects the maximum water level.
- The Active Waterjet function stops operating automatically 5 minutes after it begins. To add more water, press **Active Waterjet** again to resupply water.
- If the Active Waterjet function is activated immediately after the washer turns on, the washer will spray water for 1 second before supplying water through the Active Waterjet outlet.
- To drain water added by the Active Waterjet function, turn the power off. Water will be drained automatically for few minutes, and then you can turn the power on again when the water is completely drained.

CAUTION

- Do not block the Active Waterjet outlet with hands. Water may leak outside the tub, causing a system failure.
- Do not use the Active Waterjet to wash shoes, food, or pets.
- Due to differences in air pressure, water coming from the Active Waterjet may splatter when you first activate it.
- Make sure the lid is closed tightly before you start a load of laundry.

Delay End

You can set the washer to finish your wash automatically at a later time by choosing a delay of between 1 to 24 hours (in 1 hour increments). The hour displayed indicates the time the wash will finish.

1. Select a cycle. Then, change the cycle settings if necessary.
2. Press **Delay End** repeatedly until a desired end time is set.
3. Press and hold **Start/Pause (Hold to Start)**.
4. To cancel Delay End, restart the washer by pressing **Power**.

Real-life case

You want to finish a two-hour cycle 3 hours from now. To do this, you add the Delay End option to the current cycle with a 3-hour setting, and then press and hold **Start/Pause (Hold to Start)** at 2:00 pm. The washer starts operating at 3:00 pm and ends at 5:00 pm. Provided below is the time line for this example.

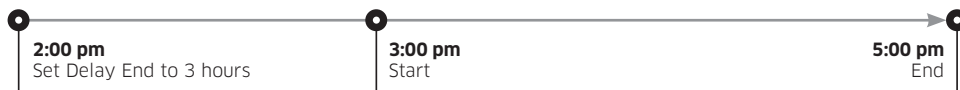

Sound Off

You can turn on or off the sound from the washing machine. Please note that this setting does not affect the sound that notifies information codes.

- To mute the sound, hold down **Super Speed** for 3 seconds.
- To unmute the sound, hold down again for 3 seconds.

ATC (Auto Temperature Control)

ATC enables the washer to control water temperatures in each washing cycle using the internal thermistor. It is designed to maintain certain washing temperatures for best results.

NOTE

- If you select **NORMAL** or **HEAVY DUTY**, you may notice the washer supplying cold water. This is normal because the machine is designed to reduce power consumption. In these cycles, the water temperature for Level 5 is similar to bath-water temperatures, and Level 3 is similar to comfortable swimming pool temperatures.
- To wash clothes at a specific temperature, you must choose a different cycle first.

Operations

Child Lock

The Child Lock function locks the washer door to prevent children from climbing into and suffocating inside the tub.

Activating the Child Lock function

Press and hold **Temp.** and **Rinse** simultaneously for approximately 3 seconds.

- When you activate the Child Lock function, the  Child Lock indicator blinks.

Using the Child Lock function

If the lid is opened when the Child Lock function is on, “**dC**” is displayed and an alarm sounds.

- If the water level in the tub is above the safe water level, “**dC**” is displayed on the LED display and the washer starts to drain water by force after 30 seconds.
- If the water level in the tub is above the safe water level and the Child Lock function is turned on while the lid is open, “**CL**” is displayed on the LED display, even if the washer is turned off, and the washer drains water by force.
- When Child Lock is on and the washer is off, if the water in the tub is above the safe water level and the lid is opened, “**CL**” is displayed on the LED display. No alarm sounds, but the washer drains the water. When the draining operation finishes, the power automatically turns off again.
- If you activate the Child Lock function while the washer is running, the **Start/Pause (Hold to Start)** button will not work.
- After the compulsory drain, “**CL**” blinks at 1 second intervals and the washer enters the “**CL**” mode. (When the washer is in the “**CL**” mode, only the **Power** button works.)
- To cancel the “**CL**” mode, turn the power off and then on again.
- To cancel the “**dC**” mode, deactivate the Child Lock function. To deactivate the Child Lock function, press and hold **Temp.** and **Rinse** simultaneously for at least 3 seconds.

Deactivating the Child Lock function

Press and hold both **Temp.** and **Rinse** simultaneously for approximately 3 seconds.

- When you deactivate the Child Lock function, the  Child Lock indicator is turned off.
- The Child Lock function prevents children or the infirm from accidentally operating the washer and injuring themselves.

WARNING

If a child enters the washer, the child may become trapped and suffocate.

CAUTION

- Once you have activated the Child Lock function, it continues working even if the power is turned off.
- Forcing the lid open can result in injury or damage to the product.

NOTE

To add laundry after you have activated the Child Lock function, you must first deactivate the Child Lock function.

DOWNLOADED cycle

You can choose from more cycles available on the SmartThings app on your smartphone.

1. On your smartphone, select the **DOWNLOADED** cycle.
 - You can choose from PERM PRESS, WOOL, ECO COLD, DENIM, and POWER RINSE.
2. Press **Power** on your washer.
3. Turn the **Cycle Selector** to **DOWNLOADED**.
4. Press and hold **Start/Pause (Hold to Start)**.

Auto dispense

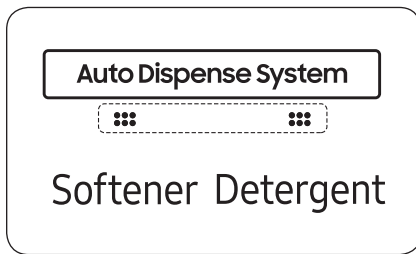

The LEDs on the **Detergent** and **Softener** buttons indicate whether the auto dispense system is on or off. If the LED on the button is off, press the button to turn on the dispenser system by setting the dosage level. You can also use the buttons to set the concentration level of detergent and softener. Refer to the following instructions to set the dosage level and the concentration level.

The **Auto Dispense System** does not work if the LEDs on the buttons are off.

Dosage level setting

Press **Detergent** or **Softener** to select the desired dosage level.

- You can select from (Less), (Standard), or (More), (Off).

Concentration level setting

1. Press and hold **Detergent** or **Softener** for 3 seconds to enter the concentration level setting.
2. Press **Detergent** or **Softener** to select the desired concentration level.
 - You can select from (Normal), (x2), or (x3).
3. When complete, press and hold **Detergent** or **Softener** for 3 seconds to confirm your changes.

NOTE

- If the **Softener** or **Detergent** button's LED blinks, refill the corresponding compartment.
- To determine your water hardness, contact your local water municipality provider. For well water, conduct a water hardness test.

Operations

SmartThings

Wi-Fi connection

On your smartphone, go to **Settings** and turn on the wireless connection and select an AP (Access Point).

- This appliance supports the Wi-Fi 2.4 GHz protocols.

Download

On an app market (Google Play Store, Apple App Store, Samsung Galaxy Apps), find the SmartThings app by searching for “SmartThings”. Download and install the app on your device.

NOTE

The app is subject to change without notice for improved performance.

Log in

You must first log into SmartThings with your Samsung account. To create a new Samsung account, follow the instructions on the app. You don't need a separate app to create your account.

NOTE

If you have a Samsung account, use the account to log in. A registered Samsung smartphone user automatically logs in.

To register your appliance to SmartThings

1. Make sure your smartphone is connected to a wireless network. If not, go to **Settings** and turn on the wireless connection and select an AP (Access Point).
2. Open **SmartThings** on your smartphone.
3. If you see the message, “A new device is found.”, select **Add**.
4. If no message appears, select **+** and select your appliance in a list of devices available. If your appliance is not listed, select **Device Type** > **Specific Device Model**, and then add your appliance manually.
5. Register your appliance to the SmartThings app as follows.
 - a. Add your appliance to SmartThings. Make sure your appliance is connected to SmartThings.
 - b. When registration is complete, your appliance appears on your smartphone.

If you're moving out, we recommend you completely wipe the appliance and do a network reset on it before you leave it behind.

If you're moving in, the easiest way to take control and remove the previous user's access is to add it to SmartThings yourself. But if you don't plan on using SmartThings, a network reset should be performed to protect your privacy. In rental properties, there's a regular change of ownership. To ensure resident privacy, Wi-Fi and/or other connectivity settings should be reset at each change of resident. Please refer to factory reset instructions in this manual.

Smart Care

To enable this function, you must first download the Samsung Smart Washer/Dryer app from the Play Store or the App Store and install it on a mobile device that has a camera function. The Smart Care function has been optimized for Galaxy and iPhone mobile devices (applicable models only).

1. When the washer detects an issue to check, an information code appears on the display. To enter Smart Care mode, press and hold **Soil** for 3 seconds.
2. The washer starts the self-diagnosis procedure and displays an information code if a problem is detected.
3. Run the Samsung Smart Washer/Dryer app on your mobile device, and then tap **Smart Care**.
4. Put the mobile device close to the washer's display so that the smartphone camera and the washer face each other. The information code will be recognized automatically by the app.
5. When the information code is recognized correctly, the app provides detailed information about the problem with applicable solutions.

NOTE

- The function name, Smart Care, may differ depending on the language.
- If the washer's display reflects light, the app may fail to recognize the information code.
- If the app fails to recognize the information code, you can enter the code manually on the app.

Maintenance

Keep the washer clean for best performance and to lengthen its life cycle.

WARNING

Certain internal parts are intentionally not grounded and may present a risk of electric shock only during servicing. Service personnel – Do not contact the following parts while the appliance is energized: Control board, heat sink, motor, inlet valve, heater, and pump.

SELF CLEAN

Certain usage and environmental conditions may result in some residue build-up or odor in the washer tub. To prevent this build-up of residue or odor causing bacteria and keep your washer tub fresh and clean, perform the SELF CLEAN cycle at least once a month or every 20 cycles. Perform the recommended procedure below when using the SELF CLEAN cycle.

1. Remove all items from the washer tub and ensure the tub is empty. Laundry left in the tub during the SELF CLEAN cycle may be damaged.
2. Press **Power** to turn on the washer.
3. Turn the **Cycle Selector** to **SELF CLEAN**.
4. Press and hold **Start/Pause (Hold to Start)**.

NOTE

- The water temperature for SELF CLEAN is defaulted to Hot. This temperature cannot be changed.
- In the case where residue is present in the washer tub, add 1 cup (8 fl.oz, 240ml) of liquid chlorine bleach to the bleach compartment before you start the SELF CLEAN cycle.
- Do not use or mix any other detergent or chemicals during the SELF CLEAN cycle. If necessary, run a RINSE+SPIN cycle after the SELF CLEAN cycle has completed to help remove any remaining residue.

CAUTION

- Check the washer tub before using the SELF CLEAN cycle. Remove any remaining water in the tub by running a SPIN ONLY cycle prior to starting the SELF CLEAN cycle.
- If there is chlorine bleach left in the washer tub for an extended period of time, rust can occur.

SELF CLEAN reminder

- After 20 washing cycles, the SELF CLEAN LED reminder icon and the SELF CLEAN cycle LED will blink on the control panel for an hour and then turn off automatically.
- The reminder will appear on the control panel for 5 additional consecutive cycles before turning off. The next reminder will not appear until another 20 cycles have been completed.

Cleaning the exterior

1. Turn off the water taps after finishing the day's washing. This will shut off the water supply to your washer and prevent the unlikely possibility of damage from escaping water. Leave the lid open to allow the inside of your washer to dry out.
2. Use a soft cloth to wipe up all detergent, bleach, or other spills as they occur. Clean the following as recommended below:
 - Control Panel – Clean with a soft, damp cloth. Do not use abrasive powders or cleaning pads. Do not spray cleaners directly on the panel.
 - Cabinet – Clean with soap and water.

Cleaning the interior

Clean the interior of your washer periodically to remove any dirt, soil, odor, mold, mildew, or bacterial residue that may remain in your washer as a result of washing clothes.

CAUTION

Failure to follow these instructions may result in unpleasant conditions, including odors and/or permanent stains on your washer or laundry.

NOTE

Hard water deposits may be removed, if needed. Use a cleaner labeled "Washer safe".

Care for an extended period of non-use

Avoid leaving the washer unused for an extended time. However, if you intend to leave the washer unused for a long period of time, follow the directions below:

1. Press **Power**, and then turn the **Cycle Selector** to **QUICK WASH**.
2. Empty the drum, and then press and hold **Start/Pause (Hold to Start)**.
3. When the cycle is complete, close the water taps and disconnect the water hoses.
4. Turn off the washer, and then unplug the power cord.
5. Open the door to let air circulate through the drum.

Maintenance

Pet hair filter (applicable models only)

NOTE

Clean the pet hair filter before every wash cycle to maximize the effectiveness of the PET CARE WASH cycle.

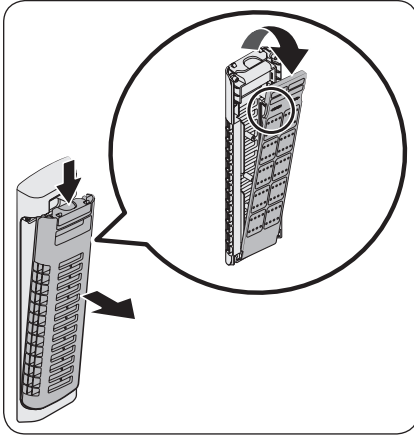

1. Press down the upper area of the filter case to remove.

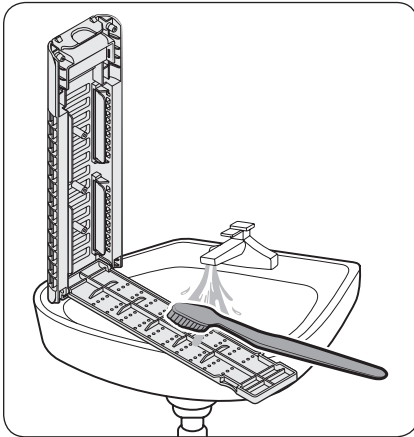

2. Unlock the cover, and clean the filter with running water and a brush.

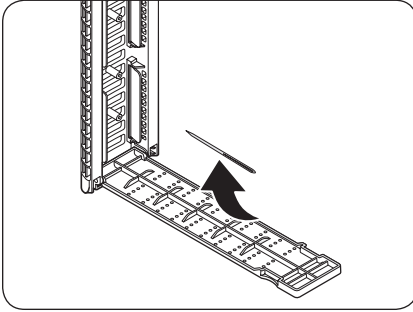

⚠ CAUTION

If a sharp object is caught in the filter, open the filter and remove the object by pushing it out from the inside to avoid damaging the filter.

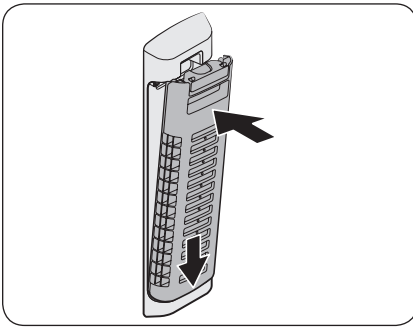

3. When cleaning is complete, close the cover and reinsert the filter case to the original position. You will hear a clicking sound when the filter case fits in.

⚠ CAUTION

Properly attach the filter. If not, the filter may fall out during the operation.

Maintenance

Cleaning the mesh filter

Clean the mesh filters in the water inlets once or twice a year.

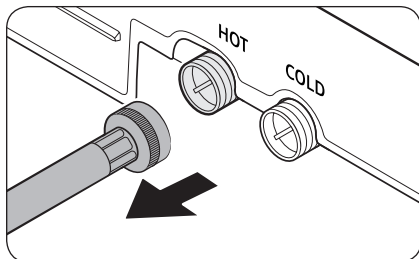

1. Turn off the washer, and then unplug the power cord.
2. Close the water taps.
3. Loosen and disconnect the water hoses from the back of the washer. Cover the end of each hose with a cloth or towel to prevent water from gushing out.

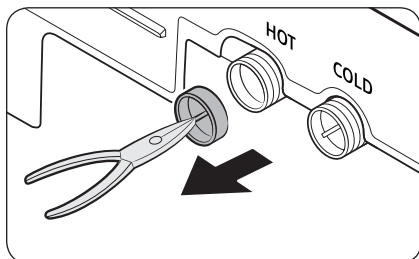

4. Use pliers to pull out the mesh filter from the inlet valves.
5. Thoroughly clean the mesh filters in water.
6. Completely dry the mesh filters. Do not dry in direct sunlight.
7. Reinsert the mesh filters, and then reconnect the water hoses.
8. Open the water taps.

NOTE

If a mesh filter is clogged, the “4C” information code appears on the washer’s display screen.

Cleaning the detergent drawer

To prevent the detergent residue buildup in the detergent drawer, clean the detergent/softener compartments once or twice a month, and whenever you refill or change the detergent or softener.

⚠ CAUTION

- Make sure to turn off the washer and unplug the power cord before cleaning.
- If you are not going to use the washer for a long time, empty the detergent/softener compartments and clean them thoroughly.
- While cleaning, do not carry individually-removed compartments. Transport the compartments in the detergent drawer to prevent the contents from spilling. Put the compartments back in place after cleaning.

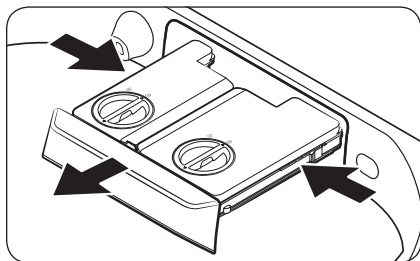

1. Fully pull out the detergent drawer.
To remove, pull the detergent drawer while pushing the ends of each side in.

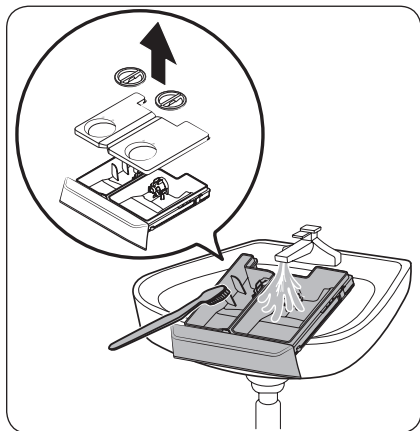

2. Remove the tops of both compartments using the pull tabs located on the back of the lid, then clean inside the compartments under warm running water with a soft brush.
 - Wipe all components with a dry towel or cloth after cleaning.

Maintenance

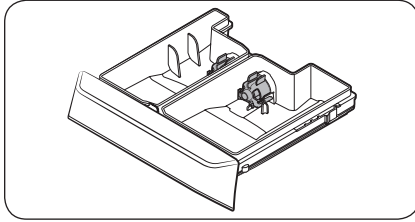

⚠ CAUTION

Do not disassemble the valves at the rear side of the detergent drawer.

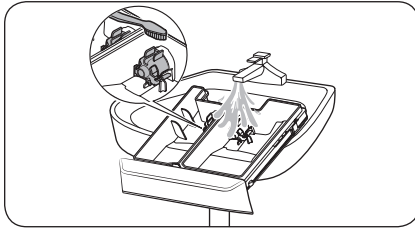

📖 NOTE

If the cleaning agent in the compartment is hardened, open the compartment, and pour lukewarm water into the compartment to dissolve the hardened agents. Then, clean inside the compartment and its rear valve thoroughly.

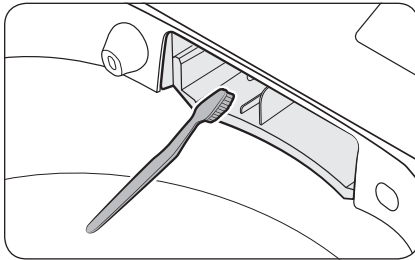

3. Clean the drawer recess using a soft brush to remove detergent residues and limescale on the drawer recess.

⚠ CAUTION

Do not spray water into the detergent drawer recess. It may cause electronic shock or fire. Unplug power if necessary.

📖 NOTE

- Make sure the drawer recess is completely dry before inserting the detergent drawer.
- Tightly attach the tops of both compartments before inserting them back into the drawer.

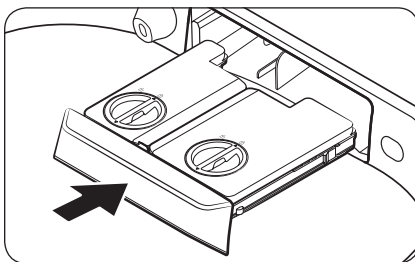

4. Insert the detergent drawer back into the washer.

⚠ CAUTION

Do not spray water into the detergent drawer recess. A wet detergent drawer recess may cause electric shock or fire. Unplug the power cord if necessary.

📖 NOTE

- Make sure the drawer recess is completely dry before inserting the detergent drawer.
- Tightly attach the tops of both compartments before inserting them back into the drawer.

Troubleshooting

Checkpoints

If you encounter a problem with the washer, first check the table below and try the suggestions.

Problem	Action
Does not turn on.	<ul style="list-style-type: none">• Make sure your home electrical system is providing electrical power that matches the requirements of the washer. See page 18.• Make sure the power cord is completely plugged in.• Check the fuse or reset the circuit breaker.• If you have turned the power off to drain the water added by the Active Waterjet function, power does not turn on until the water is completely drained.
Does not start.	<ul style="list-style-type: none">• Make sure the door is closed.• Make sure the water taps are open.• Make sure to press or tap Start/Pause (Hold to Start) to start the washing machine.• Make sure Child Lock is not activated.• Before the washing machine starts to fill, it will make a series of clicking noises to check the door lock, and then does a quick drain.• Was the door opened during the spinning cycle? Close the door, and then press or tap Start/Pause (Hold to Start) to resume.• The machine has entered Standby, has paused, or is in a soaking cycle. Please wait.• Check the fuse or reset the circuit breaker.
Water is not supplied.	<ul style="list-style-type: none">• Make sure you press or tap Start/Pause (Hold to Start) after selecting the cycle and options.• Make sure the water taps are open.• Are the mesh filters in the water inlets clogged? Clean the mesh filters by brushing with a toothbrush. See page 56.• Is the water supply cut off? If the water supply is cut off, close the tap and power off.• Straighten the water supply hoses.• Open and close the door, and then press or tap Start/Pause (Hold to Start).• If the water pressure is low, it takes longer to start washing.• If the water level is not as high as necessary or lower than expected, use the level selector to adjust the water level.
After a cycle, detergent remains in the automatic dispenser.	<ul style="list-style-type: none">• Make sure the washing machine is running with sufficient water pressure.• Make sure the detergent drawer is properly inserted.• Remove and clean the detergent drawer, and then try again.

Troubleshooting

Problem	Action
<p>Vibrates excessively or makes noise.</p>	<ul style="list-style-type: none"> • Make sure the washing machine is on a level floor. If the floor is not level, use the levelling feet to adjust the washing machine. • Make sure the washing machine is not contacting any other object. • Make sure the laundry load is balanced. • Make sure the laundry is spread evenly in the washing machine. Spread out the laundry evenly and start again. • Make sure the space around the washing machine is free of objects. • Humming is produced normally during operation. • Objects such as coins can cause noise. Remove these objects from the washing machine after washing is complete.
<p>Stops.</p>	<ul style="list-style-type: none"> • Make sure the washer's power cord is fully plugged in and the circuit is live. • Check the fuse or reset the circuit breaker. • Close the door, and then press or tap Start/Pause (Hold to Start) to start the washing machine. For your safety, the washing machine will not spin unless the door is closed. • Before the washing machine starts to fill, it will make a series of clicking noises to check the door lock, and then does a quick drain. • There may be a pause or soak period in the cycle. Wait briefly and the washing machine may start. • Make sure the inlet hose filters at the taps are not clogged. Periodically clean the filters. See page 56. • This problem can occur temporarily due to low voltage in your household electrical system. It will be resolved when the voltage returns to normal.
<p>Fills with the wrong temperature water.</p>	<ul style="list-style-type: none"> • Fully open both water taps. • Make sure the temperature selection is correct. • Make sure the hoses are connected to the correct water taps. Flush the water lines. • Disconnect the hoses and clean the mesh filters. The water inlet mesh filters may be clogged. See page 56. • While the washing machine fills, the water temperature may change as the automatic temperature control feature checks incoming water temperature. This is normal. • While the washing machine fills, you may notice just hot and/or just cold water going through the dispenser when cold or warm temperatures are selected. This is a normal function of the automatic temperature control feature as the washing machine determines the water temperature.

Problem	Action
Door (Lid) locked or will not open.	<ul style="list-style-type: none"> • While the washing machine is operating, press or tap Start/Pause (Hold to Start) to stop the washing machine. • It may take a few moments for the door lock mechanism to disengage.
Does not drain and/or spin.	<ul style="list-style-type: none"> • Check the fuse or reset the circuit breaker. • Make sure the electrical voltage is normal. • Make sure the washing machine is plugged in. • Make sure the drain hose is pointed downward. (Natural drain models only) • Make sure the drain hose is not clogged. • Make sure the drain hose is not kinked. • Straighten the drain hose. If there is a drain restriction, call for service. • Close the door, and then press or tap Start/Pause (Hold to Start). For your safety, the washing machine will not spin unless the door is closed.
Load is wet at the end of the cycle.	<ul style="list-style-type: none"> • Use the High or Extra High spin speed cycle. (Applicable model only) • Use high efficiency (HE) detergent to reduce oversudsing. • The load is too small. Small loads (one or two items) may become unbalanced and not spin completely.
Leaks water.	<ul style="list-style-type: none"> • Make sure all hose connections are tight. • Make sure the water supply hoses' rubber washers are in the correct position. Screw the hoses on tightly again. See pages 21 through 23. • Make sure the end of the drain hose is correctly inserted and secured to the drain system. • Avoid overloading. • Use high efficiency (HE) detergent to prevent oversudsing. • Make sure the water supply hose is not kinked. • If the water supply pressure is too strong, water may leak. Close the water tap a little. • Make sure water is not leaking from the water tap. If it is, repair the water tap.
Excessive suds.	<ul style="list-style-type: none"> • Use high efficiency (HE) detergent to prevent oversudsing. • Reduce the detergent amount for soft water, small loads, or lightly soiled loads. • Don't use Non-HE detergent.



Troubleshooting

Problem	Action
The spin basket or drain/supply hose is frozen.	<ul style="list-style-type: none"> • Use warm water to help loosen the water supply hoses and drain hose, and then disconnect them. Soak them in warm water. • Fill the spin basket with warm water, and then wait for about 10 minutes. • Put a hot towel on the drain hose connector. • Reconnect the water supply hoses and drain hose, and then check if water is supplied properly.
Water drains out immediately.	<ul style="list-style-type: none"> • Make sure the drain hose is not clogged, and is hung over the drain hose hook. Fill the spin basket halfway with water, and try spinning again. • Lift the end of the drain hose to prevent water from draining. Fill the spin basket halfway with water, and then run the Spin cycle after releasing the drain hose. • Make sure the drain hose is installed correctly. See pages 23 and 24. Adjust the position of the drain hose as instructed.
Stains on clothes.	<ul style="list-style-type: none"> • Select an appropriate cycle for the laundry. Use the HEAVY DUTY cycle for stained clothes. • Apply a recommended amount of detergent as instructed by the detergent manufacturer. • Clean the magic filter (if it comes with your washer) on a regular basis.
Has odors.	<ul style="list-style-type: none"> • Excessive suds collect in recesses and can cause foul odors. • Run a SELF CLEAN cycle to sanitize periodically. • Dry the washing machine interior after a cycle has finished.
Thumping sound	<ul style="list-style-type: none"> • Heavy wash loads may cause a thumping sound, and it is normal. • If the thumping sound continues, the washer may be out of balance. Stop the washer and redistribute the load in the washer.

If a problem persists, contact a local Samsung service center.

Information codes

The washer may display information codes to help you understand what is occurring with your washer better.

Code	Meaning
1C	<p>The Water Level sensor is not working properly.</p> <ul style="list-style-type: none">• Turn off the washer, unplug it, wait 30 seconds, and then plug the washer in again. If the information code remains, contact a Samsung customer service center. <p> NOTE</p> <p>If the washer displays "1C", the washer will automatically drain for 3 minutes. During this time, the Power button is inoperative.</p>
3C	<p>Check the motor for operation.</p> <ul style="list-style-type: none">• Try restarting the cycle.• If the problem continues, call for service.
4C	<p>Water is not supplied.</p> <ul style="list-style-type: none">• Make sure the water taps are open.• Make sure the water hoses are not clogged.• Make sure the water taps are not frozen.• Make sure the washing machine is operating with sufficient water pressure.• Make sure that the cold water tap and the hot water tap are properly connected.• Clean the mesh filter as it may be clogged.• Make sure water hoses are not kinked. <p> NOTE</p> <p>If the washer displays "4C", the washer will automatically drain for 3 minutes. During this time, the Power button is inoperative.</p>
4C2	<ul style="list-style-type: none">• Make sure the cold water supply hose is firmly connected to the cold water tap. If it is connected to the hot water tap, laundry may be damaged when some cycles are run.
5C	<p>Water is not draining.</p> <ul style="list-style-type: none">• Make sure the drain hose is not frozen or clogged.• Make sure the drain hose is positioned correctly, depending on the connection type.• Clean the mesh debris filter as it may be clogged.• Make sure the drain hose is straight all the way to the drain system.• Turn off the washer, unplug it, wait one minute, and then plug the washer in again. If the information code remains, contact a Samsung customer service center.

Troubleshooting

Code	Meaning
9C1	<p>The electronic control needs to be checked (Over Voltage Error).</p> <ul style="list-style-type: none"> • Check if power is supplied properly. • Turn off the washer, unplug it, wait one minute, and then plug the washer in again. If the information code remains, contact a Samsung customer service center.
9C2	<p>Low voltage detected.</p> <ul style="list-style-type: none"> • Check if the power cord is plugged in. • Turn off the washer, unplug it, wait one minute, and then plug the washer in again. If the information code remains, contact a Samsung customer service center.
AC6	<p>Inverter Communication problem.</p> <ul style="list-style-type: none"> • Turn off the washer, unplug it, wait one minute, and then plug the washer in again. If the information code remains, contact a Samsung customer service center.
dC	<p>Operating the washer with the door open.</p> <ul style="list-style-type: none"> • Make sure the door is properly closed. • Make sure laundry is not caught in the door.
HC	<p>High temperature heating check.</p> <ul style="list-style-type: none"> • Turn off the washer, unplug it, wait one minute, and then plug the washer in again. If the information code remains, contact a Samsung customer service center.
LC	<p>Check the drain hose.</p> <ul style="list-style-type: none"> • Make sure the end of the drain hose is positioned correctly. • Make sure the drain hose is not clogged. • Turn off the washer, unplug it, wait one minute, and then plug the washer in again. If the information code remains, contact a Samsung customer service center. <p> NOTE When the washer displays “LC”, the washer drains for 3 minutes. During this time, the Power button is inoperative.</p>
OC	<p>Water overflowed.</p> <ul style="list-style-type: none"> • Restart after spinning. • Turn off the washer, unplug it, wait one minute, and then plug the washer in again. If the information code remains, contact a Samsung customer service center.

Code	Meaning
PC	<p>When position of the clutch can't be detected.</p> <ul style="list-style-type: none"> • Turn off the washer, unplug it, wait one minute, and then plug the washer in again. If the information code remains, contact a Samsung customer service center.
PC1	<p>After position of the clutch is detected, if the signal from the clutch hall is incorrect.</p> <ul style="list-style-type: none"> • Turn off the washer, unplug it, wait one minute, and then plug the washer in again. If the information code remains, contact a Samsung customer service center.
Ub	<p>Spinning does not work.</p> <ul style="list-style-type: none"> • Make sure laundry is spread out evenly. • Make sure the washing machine is on a flat, stable surface. • Redistribute the load. If only one item of clothing needs washing, such as a bathrobe or pair of jeans, the final spin result might be unsatisfactory, and a "Ub" check message will appear in the display.
Ur	<p>Display for additional rinsing.</p> <ul style="list-style-type: none"> • Appears when additional rinsing cycle senses that tub is unbalanced. • Press any button/key to release the display.
8C	<p>Check the MEMS sensor.</p> <ul style="list-style-type: none"> • Power the washer off. Wait 2-3 minutes, power the washer on, and then try again. • If the problem continues, call for service.
SDC	<ul style="list-style-type: none"> • The detergent drawer is not completely closed. You will hear a clicksound when the drawer is properly closed. Close the detergent drawer until it clicks before you start the washer.
dn	<p>Firmware update is in progress through SmartThings.</p> <ul style="list-style-type: none"> • To use the product, wait about 30 minutes until the firmware update completes. (The time required to complete the firmware update may vary depending on your Internet connection.) • This code will remain on the display, regardless of power on and off, until the firmware update is complete.

For any codes not listed above, call 1-800-726-7864 (1-800-SAMSUNG).

Specifications

Fabric care chart

The following symbols provide garment care direction. The clothing care labels include symbols for drying, bleaching, drying and ironing, or dry cleaning when necessary. The use of symbols ensures consistency among garment manufacturers of domestic and imported items. Follow care label directions to optimize garment life and reduce laundering problems.

Wash cycle

	Normal
	Permanent press/Wrinkle resistant/Wrinkle control
	Gentle/Delicates
	Hand wash

Water temperature

	Hot
	Warm
	Cold

NOTE

The temperature range for Hot is 135 °F (57 °C) or below, 95 °F (35 °C) or below for Warm, and 68 °F (20 °C) or below for Cold. Wash water temperature must be a minimum of 60 °F (16 °C) for detergent activation and effective cleaning.

Bleach

	Any bleach (when needed)
	Only non-chlorine (color-safe) bleach (when needed)
	Tumble dry

Normal

	Permanent press/Wrinkle resistant/Wrinkle control
	Gentle/Delicates

Special instructions

	Line dry/Hang to dry
	Drip dry
	Dry flat







Heat setting

	High
	Medium
	Low
	Any heat
	No heat / Air





Iron dry or steam temperatures

	High
	Medium
	Low

Warning symbols for laundering

	Do not wash
	Do not wring
	Do not bleach
	Do not tumble dry
	No steam (added to iron)
	Do not iron

Dry-clean

	Dry-clean
	Do not dry-clean
	Line dry/Hang to dry
	Drip dry
	Dry flat

Helping the environment

- Your washer is manufactured from recyclable materials. If you decide to dispose of it, please observe local waste disposal regulations. Cut off the power cord so that the appliance cannot be connected to a power source. Remove the lid so that animals and small children cannot get trapped inside the appliance.
- Do not exceed the detergent quantities recommended in the detergent manufacturers' instructions.
- Use stain removal products and bleaches before the wash cycle only when necessary.
- Save water and electricity by only washing full loads (the exact amount depends upon the program used).

Specifications

Declaration of conformity

This appliance complies with UL2157.

Specification sheet

Type		Top loading washer	
Model name		WA55CG7500** WA54CG7550**	
Water pressure (psi (kPa))		20-116 (137-800)	
Spin revolution		750 rpm	
NET weight (lb (kg))		134.5 (61.0)	
Power consumption	Washing	120 V	700 W

NOTE

You can fill the tub with dry, unfolded clothes, but DO NOT OVERLOAD the tub.

LIMITED WARRANTY (U.S.A.)

SAMSUNG WASHER

LIMITED WARRANTY TO ORIGINAL CONSUMER PURCHASER WITH PROOF OF PURCHASE AND/OR PROOF OF DELIVERY

This SAMSUNG brand product, as supplied and distributed by SAMSUNG ELECTRONICS AMERICA, INC. (SAMSUNG) and delivered new, in the original carton to the original consumer purchaser, is warranted by SAMSUNG against manufacturing defects in materials or workmanship for the following limited warranty periods, starting on the date of delivery to the original consumer purchaser:

Parts and labor: One (1) year

Stainless tub part (Part Only) : Three (3) years

Washing motor follow motor type

- Washing DIT (Digital Inverter Motor) motor part (Part Only):
 - Twenty (20) years
- Washing AC motor part (Part Only):
 - Five (5) years

This limited warranty is valid only on products purchased and used in the United States that have been installed, operated, and maintained according to the instructions attached to or furnished with the product. To receive warranty service, the purchaser must contact SAMSUNG at the address or phone number provided below for problem determination and service procedures. Warranty service can only be performed by a SAMSUNG authorized service center. The original dated bill of sale and/or proof of delivery must be presented upon request to SAMSUNG or SAMSUNG's authorized service center to receive warranty service.

SAMSUNG will provide in-home service within the contiguous United States during the warranty period at no charge, subject to availability of SAMSUNG authorized servicers within the customer's geographic area. If in-home service is not available, SAMSUNG may elect, at its option, to provide transportation of the product to and from an authorized service center. If the product is located in an area where service by a SAMSUNG authorized servicer is not available, you may be responsible for a trip charge or required to bring the product to a SAMSUNG authorized service center for service.

To receive in-home service, product must be unobstructed and accessible to the service agent.

During the applicable warranty period, a product will be repaired, replaced, or the purchase price refunded, at the sole option of SAMSUNG. SAMSUNG may use new or reconditioned parts in repairing a product, or replace the product with a new or reconditioned product. SAMSUNG may also replace any part covered by this warranty with a new or reconditioned part. Replacement parts and products are warranted for the remaining portion of the original product's warranty or ninety (90) days, whichever is longer. All replaced parts and products are the property of SAMSUNG and you must return them to SAMSUNG.

LIMITED WARRANTY (U.S.A.)

This limited warranty covers manufacturing defects in materials or workmanship encountered in normal household, noncommercial use of this product and shall not cover the following: damage that occurs in shipment, delivery, installation, and uses for which this product was not intended; damage caused by unauthorized modification or alteration of the product; product where the original factory serial numbers have been removed, defaced, changed in any way, or cannot be readily determined; cosmetic damage including scratches, dents, chips, and other damage to the product's finishes; damage caused by abuse, misuse, pest infestations, accident, fire, floods, or other acts of nature or God; damage caused by use of equipment, utilities, services, parts, supplies, accessories, applications, installations, repairs, external wiring or connectors not supplied or authorized by SAMSUNG; damage caused by incorrect electrical line current, voltage, fluctuations and surges; damage caused by failure to operate and maintain the product according to instructions; in-home instruction on how to use your product; and service to correct installation not in accordance with electrical or plumbing codes or correction of household electrical or plumbing (i.e., house wiring, fuses, or water inlet hoses). The cost of repair or replacement under these excluded circumstances shall be the customer's responsibility.

Visits by an authorized servicer to explain product functions, maintenance or installation are not covered by this limited warranty. Please contact SAMSUNG at the number below for assistance with any of these issues.

EXCLUSION OF IMPLIED WARRANTIES

IMPLIED WARRANTIES, INCLUDING THE IMPLIED WARRANTIES OF MERCHANTABILITY OR FITNESS FOR A PARTICULAR PURPOSE, ARE LIMITED TO ONE YEAR OR THE SHORTEST PERIOD ALLOWED BY LAW.

Some states do not allow limitations on how long an implied warranty lasts, so the above limitations or exclusions may not apply to you. This warranty gives you specific rights, and you may also have other rights, which vary from state to state.

LIMITATION OF REMEDIES

YOUR SOLE AND EXCLUSIVE REMEDY IS PRODUCT REPAIR, PRODUCT REPLACEMENT, OR REFUND OF THE PURCHASE PRICE AT SAMSUNG'S OPTION, AS PROVIDED IN THIS LIMITED WARRANTY. SAMSUNG SHALL NOT BE LIABLE FOR SPECIAL, INCIDENTAL OR CONSEQUENTIAL DAMAGES, INCLUDING BUT NOT LIMITED TO TIME AWAY FROM WORK, HOTELS AND/OR RESTAURANT MEALS, REMODELING EXPENSES, LOSS OF REVENUE OR PROFITS, FAILURE TO REALIZE SAVINGS OR OTHER BENEFITS REGARDLESS OF THE LEGAL THEORY ON WHICH THE CLAIM IS BASED, AND EVEN IF SAMSUNG HAS BEEN ADVISED OF THE POSSIBILITY OF SUCH DAMAGES. Some states do not allow exclusion or limitation of incidental or consequential damages, so the above limitations or exclusions may not apply to you. This warranty gives you specific rights, and you may also have other rights, which vary from state to state.

SAMSUNG does not warrant uninterrupted or error-free operation of the product. No warranty or guarantee given by any other person, firm, or corporation with respect to this product shall be binding on SAMSUNG.

To obtain warranty service, please contact SAMSUNG at:

Samsung Electronics America, Inc.

85 Challenger Road

Ridgefield Park, NJ 07660

1-800-SAMSUNG (726-7864)

www.samsung.com/us/support

Warranty (CANADA)

SAMSUNG WASHER

LIMITED WARRANTY TO ORIGINAL PURCHASER

This SAMSUNG brand product, as supplied and distributed by SAMSUNG ELECTRONICS CANADA, INC. (SAMSUNG) and delivered new, in the original carton to the original consumer purchaser, is warranted by SAMSUNG against manufacturing defects in materials and workmanship for a limited warranty period of:

Parts and labor : One (1) year

Washing motor follow motor type

- Washing DIT (Digital Inverter Motor) motor part (Part Only):
 - Twenty (20) years
- Washing AC motor (Part Only):
 - Five (5) years

This limited warranty begins on the original date of purchase, and is valid only on products purchased and used in the Canada. To receive warranty service, the purchaser must contact SAMSUNG for problem determination and service procedures. Warranty service can only be performed by a SAMSUNG authorized service center. The original dated bill of sale must be presented upon request as proof of purchase to SAMSUNG or SAMSUNG's authorized service center. SAMSUNG will provide in-home service during the warranty period at no charge, subject to availability within the Canada. In-home service is not available in all areas.

To receive in-home service, product must be unobstructed and accessible to the service agent. If service is not available, SAMSUNG may elect to provide transportation of the product to and from an authorized service center.

SAMSUNG will repair, replace, or refund this product at our option and at no charge as stipulated herein, with new or reconditioned parts or products if found to be defective during the limited warranty period specified above. All replaced parts and products become the property of SAMSUNG and must be returned to SAMSUNG. Replacement parts and products assume the remaining original warranty, or ninety (90) days, whichever is longer. This limited warranty covers manufacturing defects in materials and workmanship encountered in normal, noncommercial use of this product and shall not apply to the following: damage that occurs in shipment; delivery and installation; applications and uses for which this product was not intended; altered product or serial numbers; cosmetic damage or exterior finish; accidents, abuse, neglect, fire, water, lightning, or other acts of nature or God; use of products, equipment, systems, utilities, services, parts, supplies, accessories, applications, installations, repairs, external wiring or connectors not supplied or authorized by SAMSUNG that damage this product or result in service problems; incorrect electrical line voltage, fluctuations and surges; customer adjustments and failure to follow operating instructions, maintenance and environmental instructions that are covered and prescribed in the instruction book; product removal and reinstallation; problems caused by pest infestations. This limited warranty does not cover problems resulting from incorrect electric current, voltage or supply, light bulbs, house fuses, house wiring, cost of a service call for instructions, or fixing installation errors. SAMSUNG does not warranty uninterrupted or error-free operation of the product.

EXCEPT AS SET FORTH HEREIN, THERE ARE NO WARRANTIES ON THIS PRODUCT EITHER EXPRESS OR IMPLIED, AND SAMSUNG DISCLAIMS ALL WARRANTIES INCLUDING, BUT NOT LIMITED TO, ANY IMPLIED WARRANTIES OF MERCHANTABILITY, INFRINGEMENT OR FITNESS FOR A PARTICULAR PURPOSE.

NO WARRANTY OR GUARANTEE GIVEN BY ANY PERSON, FIRM, OR CORPORATION WITH RESPECT TO THIS PRODUCT SHALL BE BINDING ON SAMSUNG. SAMSUNG SHALL NOT BE LIABLE FOR LOSS OF REVENUE OR PROFITS, FAILURE TO REALIZE SAVINGS OR OTHER BENEFITS, OR ANY OTHER SPECIAL, INCIDENTAL OR CONSEQUENTIAL DAMAGES CAUSED BY THE USE, MISUSE, OR INABILITY TO USE THIS PRODUCT, REGARDLESS OF THE LEGAL THEORY ON WHICH THE CLAIM IS BASED, AND EVEN IF SAMSUNG HAS BEEN ADVISED OF THE POSSIBILITY OF SUCH DAMAGES.

NOR SHALL RECOVERY OF ANY KIND AGAINST SAMSUNG BE GREATER IN AMOUNT THAN THE PURCHASE PRICE OF THE PRODUCT SOLD BY SAMSUNG AND CAUSING THE ALLEGED DAMAGE. WITHOUT LIMITING THE FOREGOING, PURCHASER ASSUMES ALL RISK AND LIABILITY FOR LOSS, DAMAGE, OR INJURY TO PURCHASER AND PURCHASER'S PROPERTY AND TO OTHERS AND THEIR PROPERTY ARISING OUT OF THE USE, MISUSE, OR INABILITY TO USE THIS PRODUCT. THIS LIMITED WARRANTY SHALL NOT EXTEND TO ANYONE OTHER THAN THE ORIGINAL PURCHASER OF THIS PRODUCT, IS NONTRANSFERABLE AND STATES YOUR EXCLUSIVE REMEDY.

Some provinces do not allow limitations on how long an implied warranty lasts, or the exclusion or limitation of incidental or consequential damages, so the above limitations or exclusions may not apply to you.

This warranty gives you specific rights, and you may also have other rights, which vary from province to province.

To obtain warranty service, please contact SAMSUNG at:

Samsung Electronics Canada Inc.

2050 Derry Road West

Mississauga, Ontario L5N 0B9 Canada

1-800-SAMSUNG (726-7864)

www.samsung.com/ca/support (English)

www.samsung.com/ca_fr/support (French)

Visits by a Service Engineer to explain functions, maintenance or installation is not covered by warranty. Please contact your Samsung call agent for help with any of these issues.

Memo

Memo

SAMSUNG



Scan the QR code* or visit
www.samsung.com/spsn
to view our helpful
How-to Videos and Live Shows

*Requires reader to be installed on your smartphone

Scan this with your smartphone

QUESTIONS OR COMMENTS?QUESTIONS OR COMMENTS?

COUNTRY	CALL	OR VISIT US ONLINE AT
U.S.A	1-800-SAMSUNG (726-7864)	www.samsung.com/us/support
CANADA	1-800-Samsung (726-7864)	www.samsung.com/ca/support (English) www.samsung.com/ca_fr/support (French)

