

WM24UWH

EAN Code 8017709344337
UPC Code 812895026443
Product family Washing machines
Installation Freestanding
Load type Frontal load

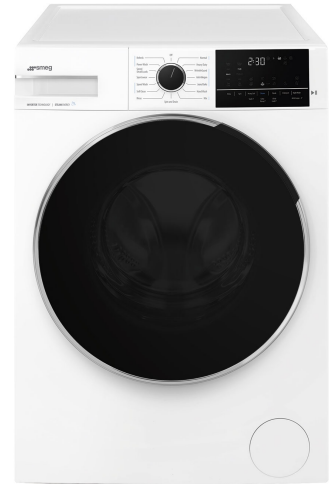

Aesthetic

Color	White	Program/temperature control knob color	Black/Chrome
Control panel color	White	Door color	Black with chrome ring
LED display color	White	Door window	Maxi - 20"
Front panel type	NovaCare	Handle color	White
Buttons color	Black	Drawer color	White
On/Off button color	White	Cabinet color	White
No. of control knobs	1	Table-top color	White

Programs

Controls Electronic
No. of programmes 15
Programs

Anti-Allergen



Normal

HeavyDuty

WrinkleGuard

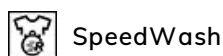
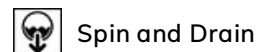

Speed Small Loads

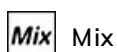
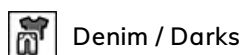

Washing Temperature

Cool	70°F	86°F
105°F	140°F	194°F

Special programs

Refresh	 Sportswear	 Antiallergic
 Jeans	 Hand-wash	 Quick





Display

Residual time indicator	Delay start	Program progress indicator
-------------------------	-------------	----------------------------

Display type



Buttons / Options

 Extra Rinse	 Quick	 Steam
 Soak	 Child lock	

Program progress indicator

Display

End-of-cycle indicator

On display

Technical Features



Motor type	Brushless/Inverter	Door diameter	13 3/8 "
Electronic control	Yes	Door opening	160°
Program selection knob	Yes	Automatic variable load	Yes
Spin setting on LED display	No spin/ 600/ 800/ 1200/ 1400/ Rinse hold	Anti-foam system	Yes
Display/led for temperature regulation	Yes	Load balancing system	Automatic
Polypropylene tank	Yes	Easy-to-access filter	Yes
Drum	Stainless steel	Child lock	Control block
Drum capacity	2.30 cu. ft.	Watersafe system	Yes

Performance / Energy Label

Supplier's name or trademark	SMEG
------------------------------	------

Electrical Connection

Nominal power	1100 W	Frequency	60 Hz
Current	10 A	Power supply cable length	55 1/8 "

Voltage (V)

120 V

Plug

(B) NEMA 5-15P

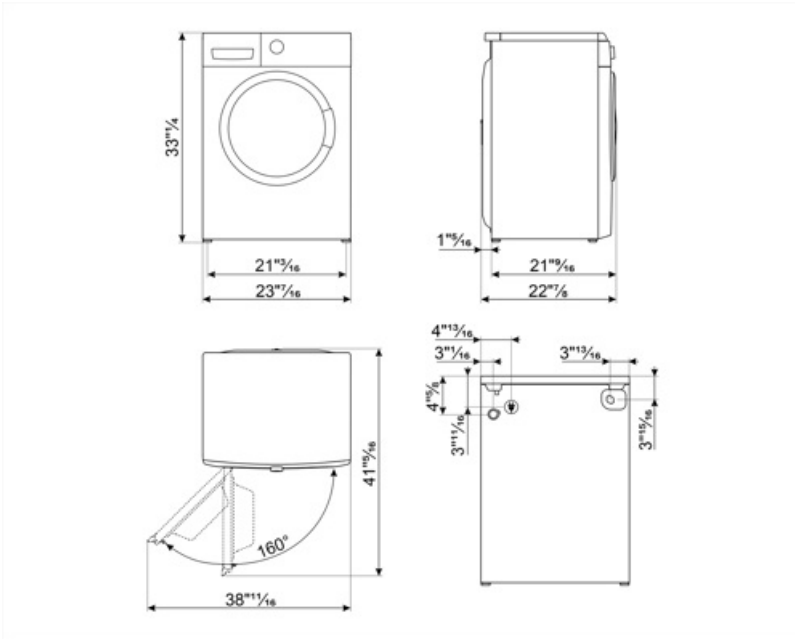





















Compatible Accessories

KITPLV2

Kit extension for dishwasher and washing machine: lenght mt. 2



Symbols glossary

 <p>Variable load: In all models of washing machines is present the system of variable load, according to which the machine automatically diversifies the wash cycle and the time of operation depending on the quantity and type of laundry introduced, allowing a significant saving of water and energy power, up to 30% compared to the versions with fixed load.</p>	 <p>Automatic Load Balancing: provides an ideal distribution of laundry in the drum. In case if the imbalance is detected, the rotation speed starts being controlled in such way to evenly redistribute laundry in the drum, and thus reduce vibration.</p>
 <p>Child lock: some models are fitted with a device to lock the programme/cycle so it cannot be accidentally changed.</p>	 <p>LED display: to show programmes, functions and options selected and the time to the end of the cycle.</p>
 <p>34 cm: Large loading hatch of 34 cm in diameter, makes laundry loading and unloading easier and faster with maximum ease of use.</p>	 <p>This option advises when the periodic cleaning of the filters is needed, in order to avoid forgetfulness and thus guarantee the perfect functioning of the dryer over time. The convenient position of the filters makes maintenance fast and extremely simple.</p>
 <p>Inverter technology: The evolution of Smeg's driers towards more intelligent and environmentally sustainable models has led to the choice of using Inverter technology with heat pumps, which reduces significantly energy consumption.</p>	 <p>Antiallergic: Antiallergic program with particular attention to the total removal of residual detergent.</p>
 <p>To drain the water in the machine.</p>	 <p>Extra Rinse: Extra Rinse: adds an extra rinse cycle to that already provided in the program chosen, to remove any residual detergent. This function is particularly suitable for those with allergies or skin problems.</p>
 <p>Hand wash: this specific programme for delicate fabrics uses slower rotations of the drum to ensure the utmost care for clothing.</p>	 <p>Jeans: a washing cycle which is kind to the colour and fabric of denim whilst minimising wrinkles.</p>
 <p>Mixed fabrics: this cycle is designed for lightly soiled laundry in a mix of cottons and synthetics, or can be used just to refresh stored items.</p>	 <p>Super fast: a programme designed to wash small amounts of laundry fast, ideal for washing lightly soiled garments.</p>
 <p>Refresh: an ideal program to refresh the garments that have been kept for a long time indoors and eliminate unpleasant odors, without having to wash.</p>	 <p>Extra rinse: The Extra rinse option: can be added to the selected programme when more thorough cleansing of special fabrics is needed.</p>
 <p>Gym: Gym, a cycle designed for washing lightly soiled garments, ie sports wear, this is a fast wash which is also kind to fabrics.</p>	 <p>Option that allow to reduce times of the selected program.</p>
 <p>SOAK_72dpi</p>	 <p>Steam Option: the steam is perfect for smoothing out creases, refreshing fabrics, neutralizing odors and releasing dirt, destroying allergens more quickly than by washing the item in water.</p>



Jeans / Dark garments: Special cycle designed to meet the washing needs of jeans or dark garments. The program allows you to wash the garments respecting colors and minimizing creases thanks to minimal mechanical action and low temperatures.



Self Clean: this programme, to be run with an empty drum, thoroughly cleans the inside of the washing machine by removing fabric and detergent residues, as well as bacteria that can accumulate during low-temperature washes.



PowerWash: this programme is ideal for small, moderately soiled loads, providing an intensive wash cycle in under one hour.

Benefit (TT)

Standard dimensions to fit any home environment, with optimal capacity and advanced features

15 programmes

Up to 15 programmes to meet every daily need

LED Display

With soft touch control and LED lights for intuitive and fast setting and selection of each option

Steam Energy Technology

Perfect removal of stains, smells, creases and allergens using steam

Steam Energy technology, uses steam, at the beginning or end of the cycle depending on the programme, to remove stains, creases, smells and allergens.

Inverter

Brushless, it offers greater energy efficiency, lower consumption and longer life, reducing wear and noise. It optimises consumption and ensures high performance while maintaining high washing efficiency.

Giant door

The size of the door offers greater convenience and versatility, facilitating the loading and unloading of laundry thanks to its wide opening, and gives a more premium and elegant look, enriching the overall design of the appliance