

XS900FZ6I

90 cm, FREEZER, 0FZ Model

BUILT-IN

X-PRO® SERIE

Fhiaba



FEATURES

- Made in Italy
- OptiView™: OptiView LED lights
- EventLift™: Easily rearrange the shelving without removal using the EvenLift system
- ProVent™: Uniform air circulation maintains consistent temperatures throughout the appliance resulting in better food preservation
- Anti-bacterial Stainless Steel Interiors Drawers: Achieve the highest food quality by storing food in the stainless steel interiors & drawers that shields against the spread of bacteria
- Total No Frost: Temperature control helping mitigate cooling loss when opening the refrigerator door. No more frost build-up that requires defrosting
- Ice Maker: Get high-quality ice cubes in a variety of sizes
- Water Filter: Get pure water and crystal-clear ice thanks to the integrated water filter and ice maker
- SuperIce™: Temporarily increase ice cube production for gatherings and parties
- Ice Size: Easily switch between medium and large ice cubes
- EquiLance™: Achieve a seamless built-in look with Fhiaba's innovative door hinge

GENERAL PROPERTIES

Equilance Hinge	YES
Soft-Closing Glides	NO
Low Vibration	YES
OptiView (Led Light Spots)	YES
Shelves	2
Type Of Shelves	glass
Door Bins	3
Fridge Interior Drawers	/
Freezer Drawers	4
Evenlift Shelves	YES
Full Extension Shelves 90° Door Opening	NO
Full Extension Drawers 90° Door Opening	NO
Defrost Process	AUTOMATIC
Ice Maker With Water Filter	YES
Door Open Alarms	YES
Shopping Fridge	NO
Shopping Freezer	YES
Power Failure Alert	YES
Water Dispenser With Water Filter	NO

XS900FZ6I

90 cm, FREEZER, 0FZ Model

BUILT-IN

X-PRO® SERIE

PRODUCT DETAIL

Fhiaba

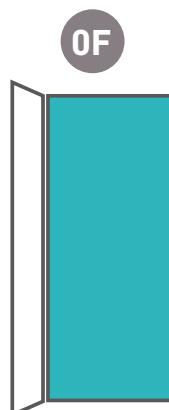
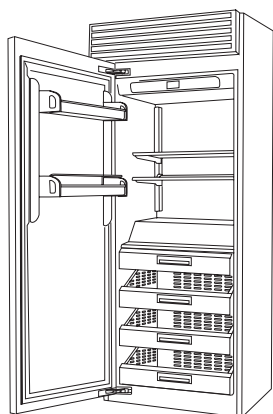

1D | 1M

freezer

D = door

M = separate microclimates

CAPACITY	
Volume Compartment 1 (L)	/
Volume Compartment 2 (L)	/
Volume Compartment 3 (L)	570
Total Net Volume (L)	570
Total Gross Volume (L)	573
Compartment 1 / Upper wine cellar capacity (bottles)	/
Compartment 2 / Lower wine cellar capacity (bottles)	/
Compartment 3 / Bottom wine cellar capacity (bottles)	/
TECHNICAL DETAILS	
Total absorbed current (A)	1.5
Voltage (V)	220-240V
Frequency (Hz)	50/60 Hz
Power Cord Length (mm)	2
Plug Type	Tipo F (Schuko) 16A IEC13 10A
Climatic class	SN/T
Noise level (dB)	41
Refrigerant (gas)	R600a
Water connection / female attachment	female 3/4"
EFFICIENCY	
New Energy Label class	E
Energy consumption (kWh/year)	365

DIMENSIONS & WEIGHT	
Height of the product (closed weels) (mm)	2120
Adjustable feet height (mm)	25
Width of the product (mm)	899
Depth of Product without handle (mm)	635
Wall cavity height (mm)	2134
Wall cavity width (mm)	900
Wall cavity depth (mm)	650
Net Weight (kg)	195
Gross Weight (kg)	216
TEMPERATURE RANGES	
Climatic compartments	1
Compartment 1 / Upper temperature (°C)	from -15 to -22
Compartment 2 / Middle temperature (°C)	
Low temp zone	NO
Compartment 3 / Low temperature (°C)	
Dual zone	NO
ACCESSORIES	

- Stainless steel sides panels
- Ice maker with water filter
- Water filtration system
- Joining kit
- Stainless steel tubular handle Ø30mm
- Stainless steel tubular handle Ø18mm
- Stainless steel panels
- Stainless steel portal for freestanding
- Extra length anti-tipping kit
- Anti-condensation
- Cleaning kit
- Water filter cartridge
- FLD - Fhiaba Link Device
- Front ventilation kit
- 90° Door stop

XS900FZ6I

90 cm, FREEZER, 0FZ Model

BUILT-IN

X-PRO® SERIE

PRODUCT SPECIFICATIONS AND DIMENSIONS

Fhiaba

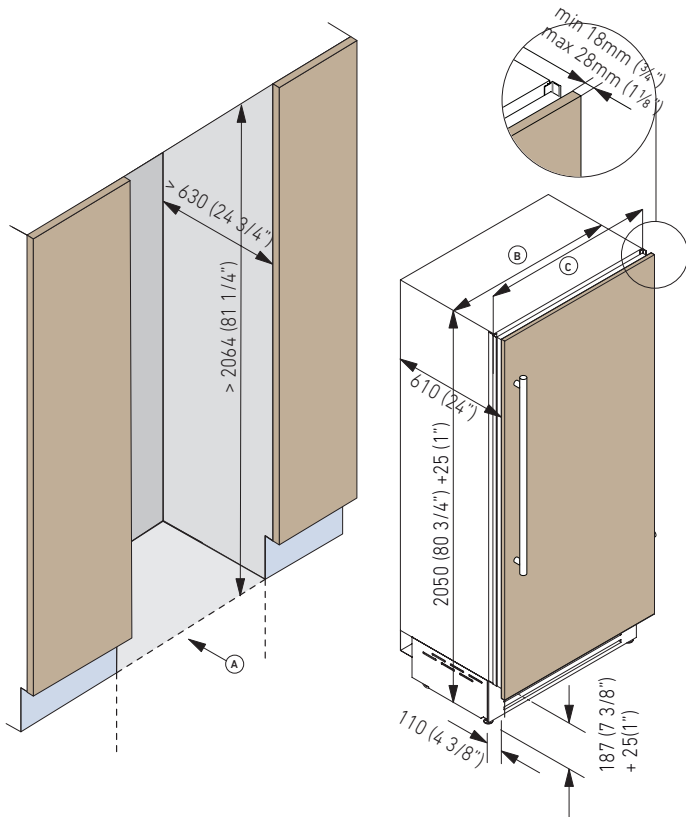

FRONT VIEW

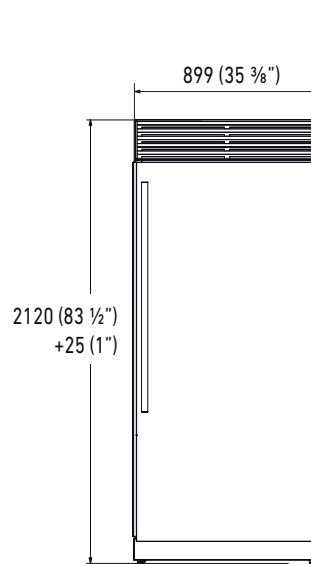

SIDE VIEW

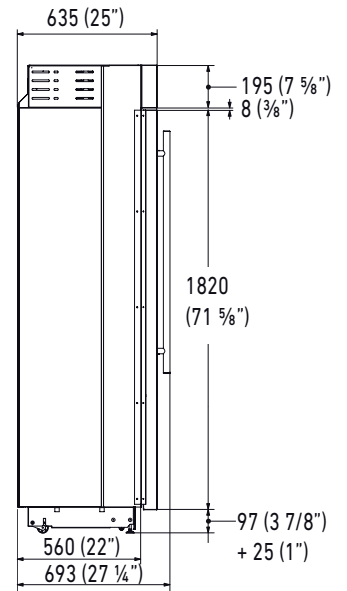

TECHNICAL DATA	
Niche Width A (mm)	900
Unit Width B (mm)	887
Unit Width with lateral frames C (mm)	899

TOP VIEW,
HINGE 105°

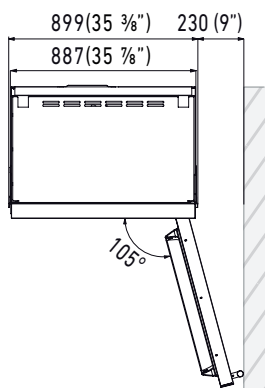

TOP VIEW,
HINGE 90°

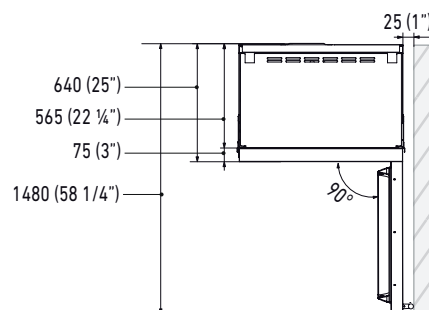

PLINTH SIZE

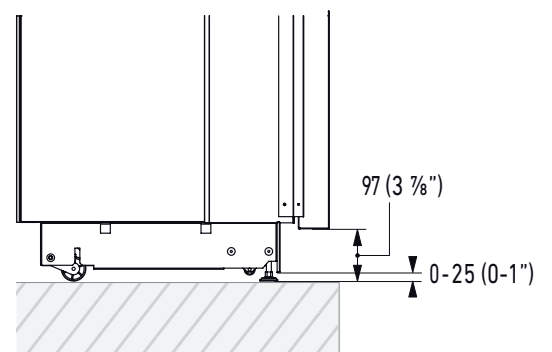

i For installation specifications, please consult with Fhiaba. For optimum installation, we recommend using the actual product as the best guide.

i Based on the adjustment of the feet and the height of the panel from the floor, the customer defines the perforated plinth to be installed on the equipment.

XS900FZ6I

90 cm, FREEZER, 0FZ Model

BUILT-IN

X-PRO® SERIE

PRODUCT SPECIFICATIONS AND DIMENSIONS

Fhiaba

Electrical Connection

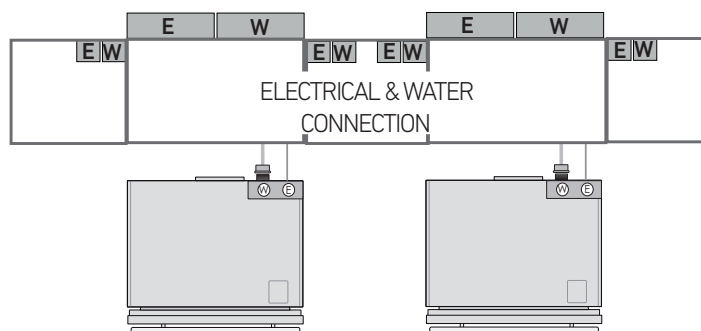

Electrical and water connections (if applicable) should be reachable without having to uninstall the appliance. If the connections must be made directly behind the appliance then it is recommended to recess those connections.
IMPORTANT: do not put the water shut-off valve behind the appliance where it will be inaccessible.

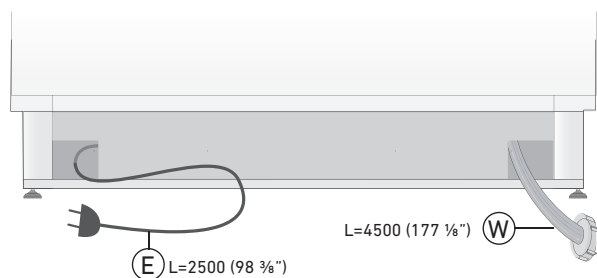
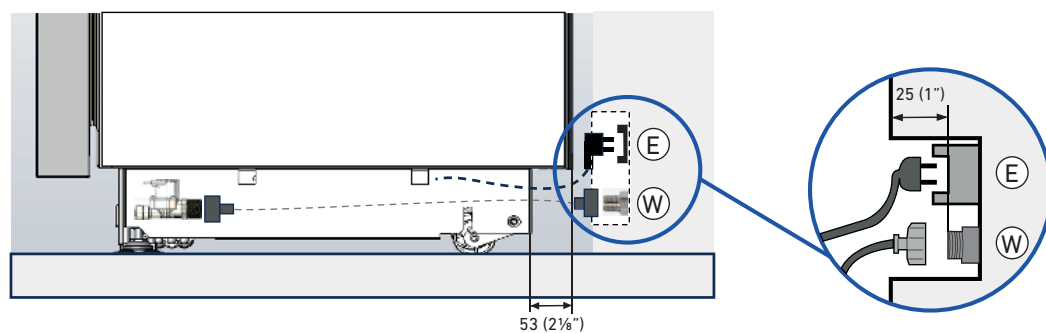

For installation specifications, please consult with Fhiaba. For optimum installation, we recommend using the actual product as the best guide.



www.fhiaba.com
4/4